

ECP200 EXPERT D7.5



Use and maintenance manual

READ AND KEEP

CONTENTS

INTRODUCTION

CHAP. 1

Page 4	1.1	General
Page 4	1.2	Product ID codes
Page 5	1.3	Overall dimensions
Page 5	1.4	Identification data

INSTALLATION

CHAP. 2

Page 6	2.1	Important information for the installer
Page 6	2.2	Standard assembly kit
Page 7	2.3	Installing the unit

FUNCTIONS

CHAP. 3

Page 9	3.1	ECP200 EXPERT D7.5 panel functions
--------	-----	------------------------------------

TECHNICAL CHARACTERISTICS

CHAP. 4

Page 10	4.1	Technical characteristics
Page 11	4.2	Warranty

PARAMETER PROGRAMMING

CHAP. 5

Page 12	5.1	Control panel
Page 12	5.2	Frontal keypad
Page 13	5.3	LED display
Page 14	5.4	General
Page 14	5.5	Key to symbols
Page 14	5.6	Setting and displaying set points
Page 15	5.7	Level 1 programming
Page 16	5.8	List of Level 1 variables
Page 17	5.9	Level 2 programming
Page 17	5.10	List of Level 2 variables
Page 19	5.11	Switching on the ECP200 EXPERT D7.5 electronic controller
Page 19	5.12	Compressor activation/deactivation conditions
Page 19	5.13	Manual defrosting
Page 20	5.14	Hot gas defrosting
Page 20	5.15	Pump down function
Page 20	5.16	Password protection

OPTIONAL

CHAP. 6

Page 21	6.1	TeleNET monitoring / supervision system
Page 21	6.2	Net configuration with Modbus-rtu protocol
Page 22	6.3	ALARM RELAY / RS485 switching

TROUBLESHOOTING

CHAP. 7

Page 23	7.1	Troubleshooting
---------	-----	-----------------

APPENDICES

Page 24	A.1	EU declaration of conformity
Page 25	A.2	ECP200 EXPERT D7.5 wiring diagram
Page 26	A.3	TeleNET network connection diagram
Page 27	A.4	Part list

CHAPTER 1: INTRODUCTION

1.1

GENERAL

DESCRIPTION:

The **ECP200 EXPERT D7.5** is a new control panel for cold rooms with a single-phase compressor up to 2 HP and three-phase+N electrical defrost up to 7500W (2500W x 3). It allows the user to control all the components on a refrigerating system: compressor, evaporator fans, defrosting elements, room light and thermostat-holder demisting element.

APPLICATIONS:

- Complete management of single-phase static or ventilated refrigeration systems up to 2 HP, with off-cycle or electrical defrosting [up to 7500W (2500W x 3)] and with direct or pump-down compressor stop.
- Control of evaporator unit only with three-phase+N electrical defrost up to 7500W (2500W x 3), with freon solenoid enabling or remote condensing unit enabling.

MAIN CHARACTERISTICS:

- Direct control of defrosting elements, evaporator fans, room light with outputs directly connectable to the various units.
- Three-phase+N electrical defrost up to 7500W (2500W x 3).
- Innovative, smartly designed ABS cover with transparent cover for access to the magneto-thermal cut-out switch, all with an IP65 protection rating so that panel can be used outside the room.
- LED indicators and large display illustrate system status.
- User-friendly keypad.
- Auxiliary relay with parameter-configured activation (alarms, temperature set point, direct control via front push-button, thermostat-holder demisting element, remote condensing unit consensus, freon solenoid control in the event of compressor pump-down operation).
- Possibility, as an alternative to an auxiliary relay, of a RS485 port for connection to the TeleNET supervision net or to a net with MODBUS-RTU protocol.
- Temperature control to 0.1 °C.

1.2

PRODUCT ID CODES

200200EXPD7.5CS

ECP200 EXPERT D7.5

controls and manages compressor, defrosting elements, evaporator fans and room light. Aux/Alarms relay. Probes included
Three-phase+N electrical defrost up to 7500W (2500W x 3).

OVERALL DIMENSIONS

1.3

Dimensions in mm



IDENTIFICATION DATA

1.4

The unit described in this manual has an ID plate on the side showing all the relevant identification data:

- Name of Manufacturer
- Code of the unit
- Serial number
- Power supply
- Rated current
- IP protection rating

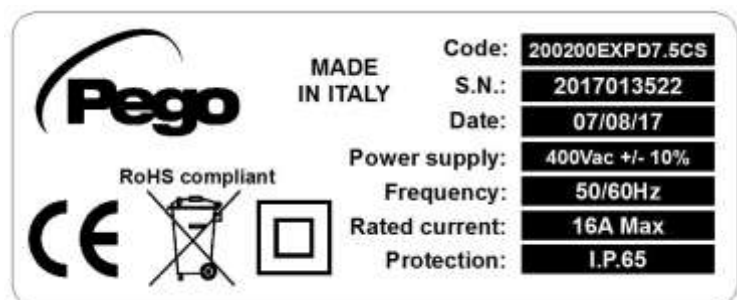

CHAPTER 2: INSTALLATION

2.1

IMPORTANT INFORMATION FOR THE INSTALLER

1. Install the device in places where the protection rating is observed and try not to damage the box when drilling holes for wire/pipe seats.
2. Do not use multi-polar cables in which there are wires connected to inductive/power loads or signalling wires (e.g. probes/sensors and digital inputs).
3. Do not fit power supply wiring and signal wiring (probes/sensors and digital inputs) in the same raceways or ducts.
4. Minimise the length of connector wires so that wiring does not twist into a spiral shape as this could have negative effects on the electronics.
5. Fit a general protection fuse upstream from the electronic controller.
6. All wiring must be of a cross-section suitable for relevant power levels.
7. When it is necessary to make a probe/sensor extension, the wires must have a cross-section of at least 1mm².
8. To predispose to the source a 16A quadrupole differential magnetothermic protection.

2.2

STANDARD ASSEMBLY KIT

For the purposes of assembly and use, the electronic **ECP200 EXPERT D 7.5** control unit comes with:

- N° 3 seals, to be fitted between the fixing screws and the box back panel
- N° 1 user's manual.

INSTALLING THE UNIT

2.3

Fig. 1: Raise the transparent cover that shields the magneto-thermal cut-out switch and remove the screw cover on the right-hand side.



Fig. 2: Undo the 4 fixing screws at the front of the box.



Fig. 3: Close the transparent cut-out switch cover.



Fig.4: Open the front of the box, lift it and slide the two hinges out as far as they will go.



Fig. 5: Press on the sides of the hinges to remove them from their seats and so remove the front panel completely.



Fig. 6: Use the three existing holes to fix the box back panel to the wall: use three screws of a length suitable for the thickness of the wall to which the panel will be attached. Fit a rubber washer (supplied) between each screw and the box backing.



Fig. 7: Hook the frontal panel back up to the lower part of the box by inserting the two hinges in their seats and, bending them, rotate downwards 180° to gain access to the electronic board.

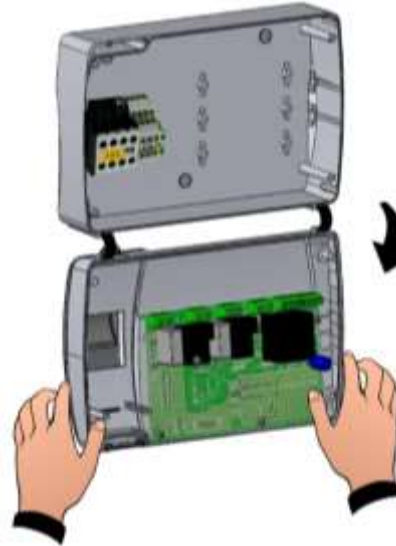

Make all the electrical connections as illustrated in the diagram for the corresponding model (see relative table in APPENDICES).

To effect correct electrical connection and maintain the protection rating, use appropriate wire/raceway grips to ensure a good seal.

Route the wiring inside the unit in as tidy a fashion as possible: be especially careful to keep power wires away from signal wires. Use clips to hold wires in place.



Fig. 8: close the front panel, making sure that all the wires are inside the box and that the box seal sits in its seat properly.

Tighten the front panel using the 4 screws.

Power up the panel and carry out thorough reading/programming of all the parameters.



Be careful not to over-tighten the closure screws as this could warp the box and compromise proper operation of the membrane-type keypad.

Install short-circuit overload safety devices on all the power cables connected to the ECP200 EXPERT so as to prevent damage to the device. Work and/or maintenance must ONLY be carried out on the unit after disconnecting the panel from the power supply and from any inductive/power loads: doing so allows the worker to do his job safely.



CHAPTER 3: FUNCTIONS

3.1

ECP200 EXPERT D7.5 PANEL FUNCTIONS

- Display and adjustment of cold room temperature accurate to 0.1°C.
- Display of evaporator temperature from parameter.
- System control activation/deactivation.
- System warnings (probe/sensor errors, minimum and maximum temperature warnings, compressor shutdown).
- Evaporator fans control.
- Automatic and manual defrost (static, heating element, cycle inversion).
- Direct control of compressor unit up to 2 HP.
- Room light, via panel key or door switch.
- Alarms/auxiliary relay.

CHAPTER 4: TECHNICAL CHARACTERISTICS**TECHNICAL CHARACTERISTICS****4.1**

Power supply	
Voltage	400 V~ three phases + neutral $\pm 10\%$ 50-60Hz
Max power (only electronics)	~ 7 VA
Protection to be installed upstream of the power line	Magnetothermic quadripolar differential 16A Curve D (it has to be added by installer)
Cold room conditions	
Working temperature	-5 \div 50°C
Storage temperature	-10 \div 70°C
Relative humidity	Less than 90% UR
General characteristics	
Type of sensors that can be connected	NTC 10K 1%
Resolution	0,1°C
Sensor read precision	$\pm 0,5^\circ\text{C}$
Read range	-45...+45 °C
ECP200 EXPERT D7.5 - Output characteristics - max applicable load (230VAC)	
Compressor	1500W (AC3) Single-phase
Elements	7500W (2500W 230V x 3) (AC1) Threephases+N
Fans	500W (AC3) Single-phase
Room light	800W (AC1) Single-phase
Alarm contact (non-powered contact)	100W
Dimensional characteristics	
Dimensions	18cm x 9.6cm x 26.3cm (HxPxL)
Insulation / mechanical characteristics	
Box protection rating	IP65
Box material	Self-extinguishing ABS
Type of insulation	Class II

4.2

WARRANTY

The **ECP200 EXPERT D7.5** series products are covered by a 24-months warranty against all manufacturing defects as from the date indicated on the product ID code.

In case of defect the product must be appropriately packaged and sent to our production plant or to any authorized Service Center with the prior request of the Return Authorization Number.

Customers are entitled to have defective products repaired, spare parts and labour included. The costs and the risks of transport are at the total charge of the Customer. Any warranty action does not extend or renew its expiration.

The Warranty does not cover:

- Damages resulting from tampering, impact or improper installation of the product and its accessories.
- Installation, use or maintenance that does not comply with the instructions provided with the product.
- Repair work carried out by unauthorized personnel.
- Damage due to natural phenomena such as lightning, natural disasters, etc...

In all these cases the costs for repair will be charged to the customer.

The intervention service in warranty can be refused when the equipment is modified or transformed.

Under no circumstances **Pego S.r.l.** will be liable for any loss of data and information, costs of goods or substitute services, damage to property, people or animals, loss of sales or earnings, business interruption, any direct, indirect, incidental, consequential, damaging, punitive, special or consequential damages, in any way whatsoever caused, whether they are contractual, extra contractual or due to negligence or other liability arising from the use of the product or its installation.

Malfunction caused by tampering, bumps, inadequate installation automatically declines the warranty. It is compulsory to observe all the instructions in this manual and the operating conditions of the product.

Pego S.r.l. disclaims any liability for possible inaccuracies contained in this manual if due to errors in printing or transcription.

Pego S.r.l. reserves the right to make changes to its products which it deems necessary or useful without affecting its essential characteristics.

Each new release of the Pego product user manual replaces all the previous ones.

As far as not expressly indicated, is applicable the Law and in particular the art. 1512 C.C. (Italian Civil Code).

For any controversy is elected and recognized by the parties the jurisdiction of the Court of Rovigo.

CHAPTER 5: PARAMETER PROGRAMMING



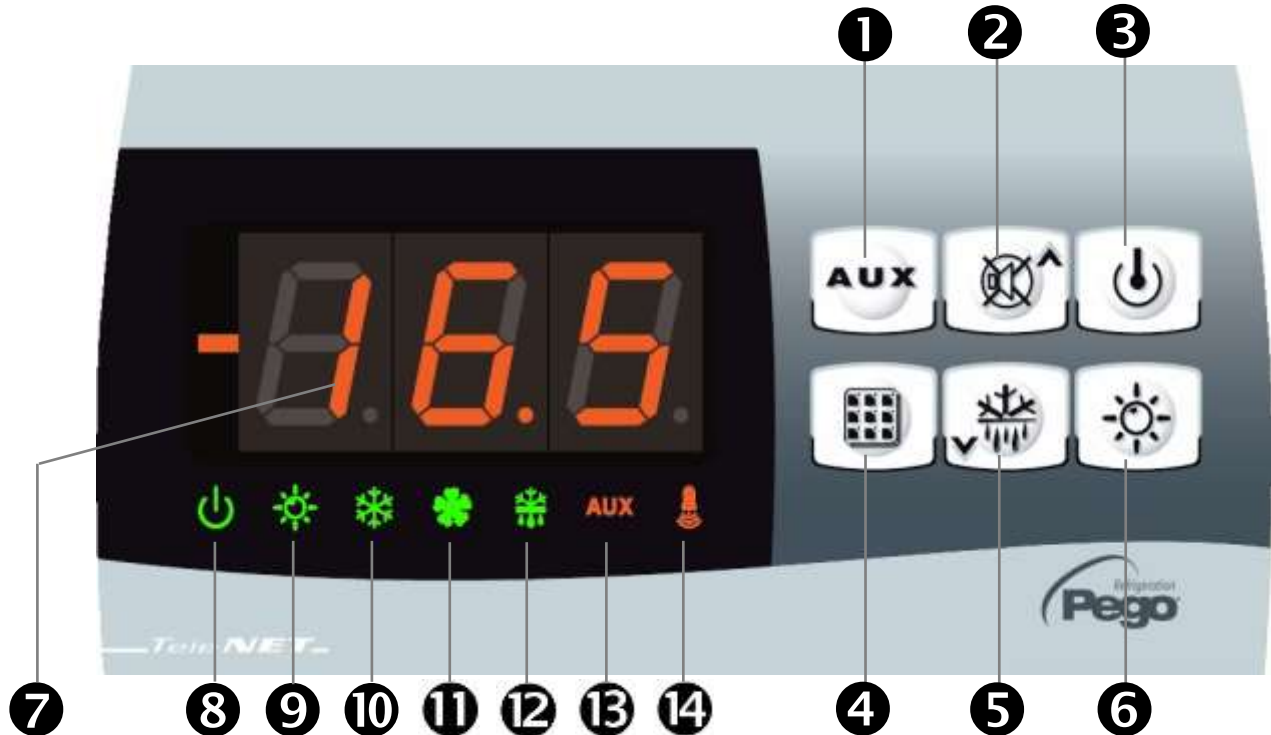

CONTROL PANEL

5.1



FRONT KEYPAD

5.2

- 1**  **AUXILIARY RELAY CONTROL**
 (it manually controls the auxiliary relay, if parameter AU=1)
- 2**  **UP / MUTE BUZZER ALARM**
- 3**  **STANDBY** (press it to stop the system. The standby light flashes)
- 4**  **SET AMBIENT TEMPERATURE**

5  DOWN / MANUAL DEFROST

6  ROOM LIGHT

LED DISPLAY

5.3

7 Cold room temperature / parameters

8  Stand-by (flashes on stand-by. Outputs are deactivated)

9  Room light (flashes if door switch activated)

10  Cold (indicates activation of compressor)

11  Fans

12  Defrosting

13 **AUX** Auxiliary

14  Alarm/warning

5.4

GENERAL



To enhance safety and simplify the operator's work, the **ECP200 EXPERT D7.5** has two programming levels; the first level (Level 1) is used to configure the frequently-modified **SETPOINT** parameters. The second programming level (Level 2) is for general parameter programming of the various controller work modes.

It is not possible to access the Level 2 programming directly from Level 1: you must exit the programming mode first.

5.5

KEY TO SYMBOLS

For purposes of practicality the following symbols are used:

- (▲) the UP key  is used to increase values and mute the alarm.
- (▼) the DOWN key  is used to decrease values and force defrosting.

5.6

SETTING AND DISPLAYING THE SET POINTS

1. Press the **SET key** to display the current **SETPOINT** (temperature).
2. Hold down the **SET key** and press the (▲) or (▼) keys to modify the **SETPOINT**.
Release the **SET key** to return to cold room temperature display: the new setting will be saved automatically.

LEVEL 1 PROGRAMMING (User level)

5.7

To gain access to the Level 1 configuration menu proceed as follows:

1. Press the (▲) and (▼) keys simultaneously and keep them pressed for a few seconds until the first programming variable appears on the display.
 2. Release the (▲) and (▼) keys.
 3. Select the variable to be modified using the (▲) or (▼) key.
 4. When the variable has been selected it is possible:
 - to display the setting by pressing SET key.
 - to modify the setting by pressing the SET key together with the (▲) or (▼) key.
- When configuration values have been set you can exit the menu by pressing the (▲) and (▼) keys simultaneously for a few seconds until the cold room temperature reappears.
5. The new settings are saved automatically when you exit the configuration menu.

5.8

LIST OF LEVEL 1 VARIABLES (User level)

VARIABLES	MEANING	VALUE	DEFAULT
<i>r0</i>	Temperature difference compared to main SETPOINT	0.2 - 10 °C	2°C
<i>d0</i>	Defrost interval (hours)	0 - 24 hours	4 hours
<i>d2</i>	End-of-defrost setpoint. Defrost is not executed if the temperature read by the defrost sensor is greater than <i>d2</i> . (If the sensor is faulty defrosting is timed)	-35 - 45 °C	15°C
<i>d3</i>	Max defrost duration (minutes)	1 - 60 min	25 min
<i>d7</i>	Drip duration (minutes) At the end of defrost the compressor and fans remain at standstill for time <i>d7</i> , the defrost LED on the front panel flashes.	0 - 10 min	0 min
<i>F5</i>	Fan pause after defrost (minutes) Allows fans to be kept at standstill for a time <i>F5</i> after dripping. This time begins at the end of dripping. If no dripping has been set the fan pause starts directly at the end of defrost.	0 - 10 min	0 min
<i>A1</i>	Minimum temperature alarm Allows user to define a minimum temperature for the room being refrigerated. Below value <i>A1</i> an alarm trips: the alarm LED flashes, displayed temperature flashes and the buzzer sounds to indicate the problem.	-	-45°C
<i>A2</i>	Maximum temperature alarm Allows user to define a maximum temperature for the room being refrigerated. Above value <i>A2</i> an alarm trips: the alarm LED flashes, displayed temperature flashes and the buzzer sounds to indicate the problem.	-	+45°C
<i>tEu</i>	Evaporator sensor temperature display	Displays evaporator temperature (displays nothing if dE =1)	read only

LEVEL 2 PROGRAMMING (Installer level)

5.9

To access the second programming level press the UP (▲) and DOWN (▼) keys and the LIGHT key simultaneously for a few seconds.

When the first programming variable appears the system automatically goes to stand-by.

1. Select the variable to be modified by pressing the UP (▲) and DOWN (▼) keys. When the parameter has been selected it is possible to:
 2. View the setting by pressing the SET key.
 3. Modify the setting by holding the SET key down and pressing the (▲) or (▼) key.
 4. When configuration settings have been completed you can exit the menu by pressing the (▲) and (▼) keys simultaneously and keeping them pressed until the room temperature reappears.
 5. Changes are saved automatically when you exit the configuration menu.
 6. Press the STAND-BY key to enable electronic control.

LIST OF LEVEL 2 VARIABLES (Installer level)

5.10

VARIABLES	MEANING	VALUES	DEFAULT
AC	Door switch status	0 = normally open 1 = normally closed	0
F3	Fan status with compressor off	0 = Fans run continuously 1 = Fans only run when compressor is working	1
F4	Fan pause during defrost	0 = Fans run during defrost 1 = Fans do not run during defrost	1
dE	Sensor presence If the evaporator sensor is disabled defrosts are carried out cyclically with period d0: defrosting ends when an external device trips and closes the remote defrost contact or when time d3 expires.	0 = evaporator sensor present 1 = no evaporator sensor	0
d1	Defrost type , cycle inversion (hot gas) or with heater elements	1 = hot gas 0 = element	0
Ad	Net address for connection to TeleNET supervision system or Modbus	0 ÷ 31 (with AU=3) 1 ÷ 247 (with AU=7)	0
Ald	Minimum and maximum temperature signalling and alarm display delay	1...240 min	120 min
C1	Minimum time between shutdown and subsequent switching on of the compressor.	0...15 min	0 min
CAL	Cold room sensor value correction	-10...+10	0

Pc	Compressor protection contact status	0 = NO 1 = NC	0 = NO
doC	Compressor safety time for door switch: when the door is opened the evaporator fans shut down and the compressor will continue working for time doC , after which it will shut down.	0...5 minutes	0
tdo	Compressor restart time after door opening. when the door is opened and after tdo time, it's setted back the normal functioning giving door open alarm (Ed) With tdo=0 the parameter is disabled.	0...240 min 0 = disabled	0
Fst	FAN shutdown TEMPERATURE The fans will stop if the temperature value read by the evaporator sensor is higher than this value.	-45...+45°C	+45°C
Fd	Fst differential	0...+10°C	2°C
LSE	Minimum value attributable to setpoint.	-45... HSE °C	-45°C
HSE	Maximum value attributable to setpoint.	+45... LSE °C	+45°C
tA	NO – NC alarm relay switching	0 = activates when alarm is on 1 = deactivates when alarm is on	1
AU	Auxiliary/alarm relay control (only on version with relay fitted)	0 = alarm relay 1 = manual auxiliary relay controlled via AUX key 2 = automatic auxiliary relay managed by StA temp. setting with 2°C differential 3 = relay disabled / TeleNET function 4 = pump down function (see CHAP 5.15) 5 = free voltage contact for condensing unit (AUX relay and compressor relay in parallel) 6 = Contact for casing element control (AUX relay closed with compressor output inactive). 7 = relay disabled / Modbus-RTU function	0
StA	Temp. setting for aux. relay	-45...+45°C	0
In1	Man in cold room alarm Select input INP1 on the board as <i>compressor protection alarm</i> or as <i>man in cold room alarm</i> (contact NC).	0 = compressor protection 1 = man in room alarm	0
P1	Password type of protection (active when PA is not equal 0)	0 = only display set point 1 = display set point, AUX, light access 2 = access in programming not permitted 3 = access in second level programming not permitted	3
PA	Password (see P1 for the type of protection)	0...999 0 = not active	0
reL	Software release	indicates software version	Read only

5.11 SWITCHING ON THE ECP200 EXPERT D7.5 ELECTRONIC CONTROLLER

After wiring the electronic controller correctly, power up at 230 V AC; the display panel will immediately emit a beep and all the LEDs will come on simultaneously for a few seconds.

5.12 COMPRESSOR ACTIVATION/DEACTIVATION CONDITIONS

The **ECP200 EXPERT D7.5** controller activates the compressor when cold room temperature exceeds setting+differential (r0); it deactivates the compressor when cold room temperature is lower than the setting.

If the Pump-down function is selected (Parameter AU=4) refer to chapter 5.15 for the compressor activation / deactivation conditions.

5.13 MANUAL DEFROSTING

To defrost just press the dedicated key (see section 5.2) to activate the elements relay. Defrosting will not take place if the end-of-defrost temperature setting (d2) is lower than the temperature detected by the evaporator sensor. Defrosting ends when the end-of-defrost temperature (d2) or maximum defrost time (d3) is reached.

HOT GAS DEFROSTING**5.14**

Set parameter d1 =1 to defrost in cycle inversion mode.

The compressor relay and defrost relay are activated throughout the defrost phase.

To ensure proper control of the system the installer must use the defrost output: this must allow opening of the cycle inversion solenoid valve and closure of the liquid solenoid valve. For capillary systems (without thermostat valve) it is only necessary to control the cycle inversion solenoid valve via the defrost relay control

PUMP DOWN FUNCTION**5.15**

Pump down function is activated when parameter AU=4 (only for version with AUX/Alarm relay).

Connect pump down pressostat on the digital input INP-1. The compressor is directly controlled by pressostat.

Connect evaporator solenoid valve on the AUX relay. The solenoid is controlled directly by thermostat.

PASSWORD FUNCTION**5.16**

When parameter PA is setting with value different to 0 the protection function is activated.

See parameter P1 for the different protection.

When PA is setting the protection start after two minutes of inactivity. On display appear 000. With up/down modify the number, with set key confirm it.

Use universal number 100 if you don't remember the password.

CHAPTER 6: OPTIONAL KITS

6.1

TeleNET MONITORING/SUPERVISION SYSTEM

For **TeleNET** connections to enable RS485 as indicated at chapter 6.3 and follow the scheme below. For electrical connections see Annex **A.3** on page 26 of this manual.

WARNING: During configuration, at entry "Module" to select the entry "Instrument ECP Base Series / ECP Expert Series".

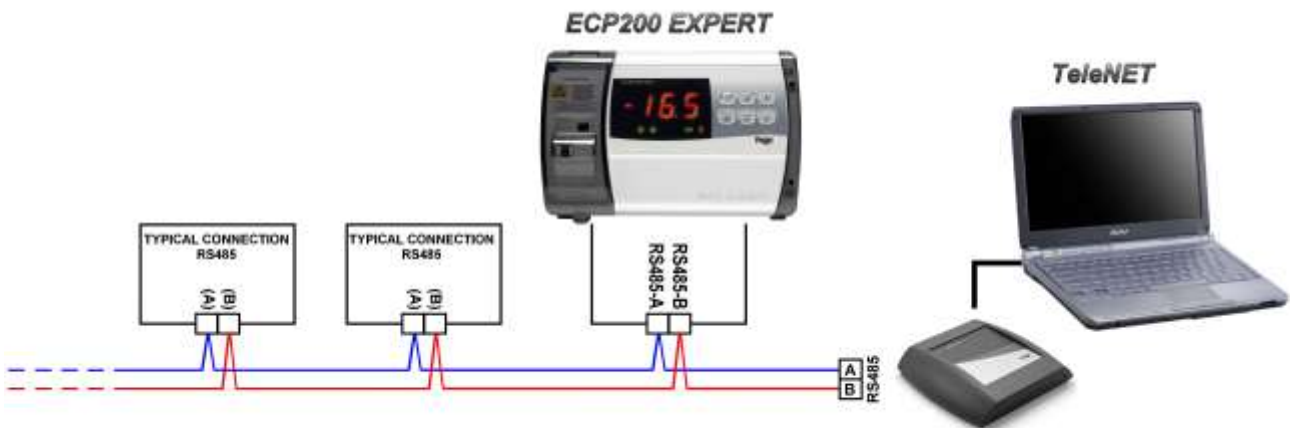

6.2

NET CONFIGURATION WITH MODBUS-RTU PROTOCOL

For **RS485** connections with **Modbus-RTU** protocol, to enable RS485 output as indicated at chapter 6.3 and follow the scheme below.

Refer to MODBUS-RTU_ECP200T1 user manual (available on Pego Internet web site) for MODBUS-RTU communication protocol specification.

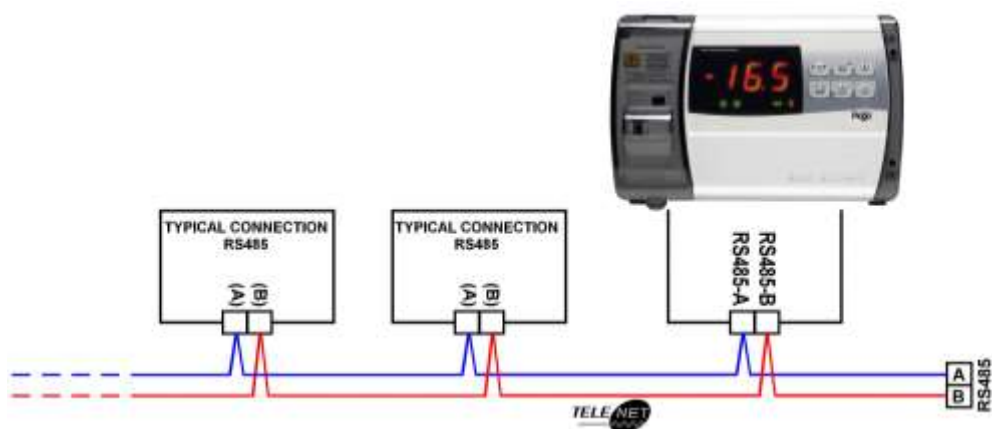

ALARM RELAY / RS485 SWITCHING

6.2

Open the front of the box as described in Chap. 2.3 (page 6): rotate it downwards 180° to gain access to the electronic board.

Undo the 6 CPU board fixing screws: remove the board from the frontal part of the box in ABS.

Configure the jumper from JUMPER JP2 (placed on the front of electrical board near the display far down on the right) following one of the ensuing options.

**RS485 output selection:**

Insert the jumper JP2 on 3-2 position and set the 2nd level variable **AU=3 (TeleNET)** or **AU=7 (Modbus-RTU)**.

The connection clamps are RS485 (A) and RS485_(B) on board of electrical board. Remember besides to assign an univocal net address in the current instruments net. (Ad 2nd level parameter).

Warning! with this configuration auxiliary relay is disabled.

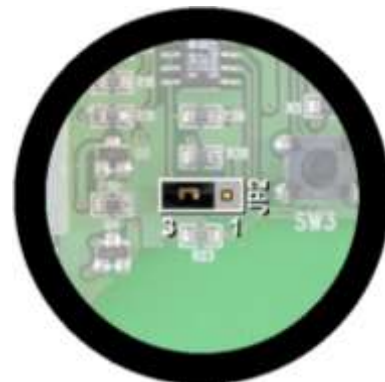
**AUX/Alarm relay selection:**

Insert the jumper JP2 in 2-1 position and set the 2nd level variable AU to a value different from 3 and 7 according to the needed function. Clamps of configurable relay clean contact are on AUX/ALL output, on board of electronic board.

Warning! With this configuration RS485 connection is disabled.

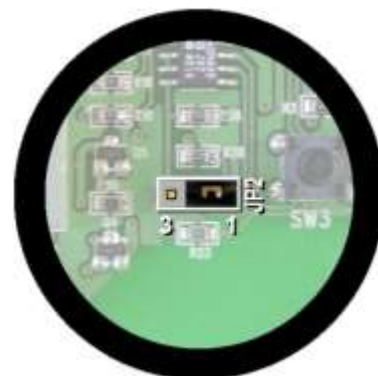

CHAPTER 7: TROUBLESHOOTING

7.1

TROUBLESHOOTING

In the event of any anomalies the ECP200 EXPERT D7.5 warns the operator by displaying alarm codes and sounding the warning buzzer inside the control panel. If an alarm is tripped, the display will show one of the following messages:

ALARM CODE	POSSIBLE CAUSE	SOLUTION
E0	<i>Cold room temperature sensor not working properly</i>	<ul style="list-style-type: none"> • Check that cold room temperature sensor is working properly • If the problem persists replace the sensor
E1	<i>Defrost sensor not working properly</i> (In this case defrosts will last time d3)	<ul style="list-style-type: none"> • Check that defrost sensor is working properly • If the problems persists replace the sensor
E2	<i>Eeprom alarm</i> An EEPROM memory alarm has been detected (All outputs except the alarm one are deactivated)	<ul style="list-style-type: none"> • Switch unit off and back on
E8	<i>Man in cold room alarm</i>	<ul style="list-style-type: none"> • Reset the alarm input inside the cold room
Ec	<i>Compressor protection tripped</i> (e.g. thermal protection or max pressure switch) (All outputs except the alarm one – where applicable – are deactivated)	<ul style="list-style-type: none"> • Check that compressor is working properly • Check compressor absorption • If the problem persists contact the technical assistance service
Ed	<i>Open door Alarm.</i> When the door is opened and after tdo time, it's setted back the normal functioning giving door open alarm (Ed)	<ul style="list-style-type: none"> • Check door switch status • Check door switch connections • If the problem persists contact the technical assistance service
Temperature shown on display is flashing	<i>Minimum or maximum temperature alarm.</i> The temperature inside the cold room has exceeded the min. or max. temperature alarm setting (see variables A1 and A2, user programming level)	<ul style="list-style-type: none"> • Check that the compressor is working properly. • Sensor not reading temperature properly or compressor start/stop control not working.

APPENDICES

A.1

EU DECLARATION OF CONFORMITY

LA PRESENTE DICHIARAZIONE DI CONFORMITA' E' RILASCIATA SOTTO LA RESPONSABILITA' ESCLUSIVA DEL FABBRICANTE:
THIS DECLARATION OF CONFORMITY IS ISSUED UNDER THE EXCLUSIVE RESPONSIBILITY OF THE MANUFACTURER:



PEGO S.r.l. Via Piacentina 6/b, 45030 Occhiobello (RO) – Italy –

DENOMINAZIONE DEL PRODOTTO IN OGGETTO / DENOMINATION OF THE PRODUCT IN OBJECT

MOD.: **ECP200 EXPERT D7.5**

IL PRODOTTO DI CUI SOPRA E' CONFORME ALLA PERTINENTE NORMATIVA DI ARMONIZZAZIONE DELL'UNIONE EUROPEA:
THE PRODUCT IS IN CONFORMITY WITH THE RELEVANT EUROPEAN HARMONIZATION LEGISLATION:

Direttiva Bassa Tensione (LVD):	2014/35/UE
<i>Low voltage directive (LVD):</i>	2014/35/EU
Direttiva EMC:	2014/30/UE
<i>Electromagnetic compatibility (EMC):</i>	2014/30/EU

LA CONFORMITA' PRESCRITTA DALLA DIRETTIVA E' GARANTITA DALL'ADEMPIMENTO A TUTTI GLI EFFETTI DELLE SEGUENTI NORME:
THE CONFORMITY REQUIRED BY THE DIRECTIVE IS GUARANTEED BY THE FULFILLMENT TO THE FOLLOWING STANDARDS:

Norme armonizzate: **EN 60730-1:2016, EN 60730-2-9:2010, EN 61000-6-1:2007, EN 61000-6-3:2007**
 European standards: **EN 60730-1:2016, EN 60730-2-9:2010, EN 61000-6-1:2007, EN 61000-6-3:2007**

IL PRODOTTO E' COSTITUITO PER ESSERE INCORPORATO IN UNA MACCHINA O PER ESSERE ASSEMBLATO CON ALTRI MACCHINARI PER COSTITUIRE UNA MACCHINA CONSIDERATE DALLA DIRETTIVA: 2006/42/CE "Direttiva Macchine".

THE PRODUCT HAS BEEN MANUFACTURED TO BE INCLUDED IN A MACHINE OR TO BE ASSEMBLED TOGETHER WITH OTHER MACHINERY TO COMPLETE A MACHINE ACCORDING TO DIRECTIVE: EC/2006/42 "Machinery Directive".

Firmato per nome e per conto di:
 Signed for and on behalf of:

Pego S.r.l.
 Lisa Zampini
 Procuratore Generale

Luogo e Data del rilascio:
 Place and Date of Release:

Occhiobello (RO), 08/01/2018

ECP200 EXPERT D7.5 WIRING DIAGRAM

A.2

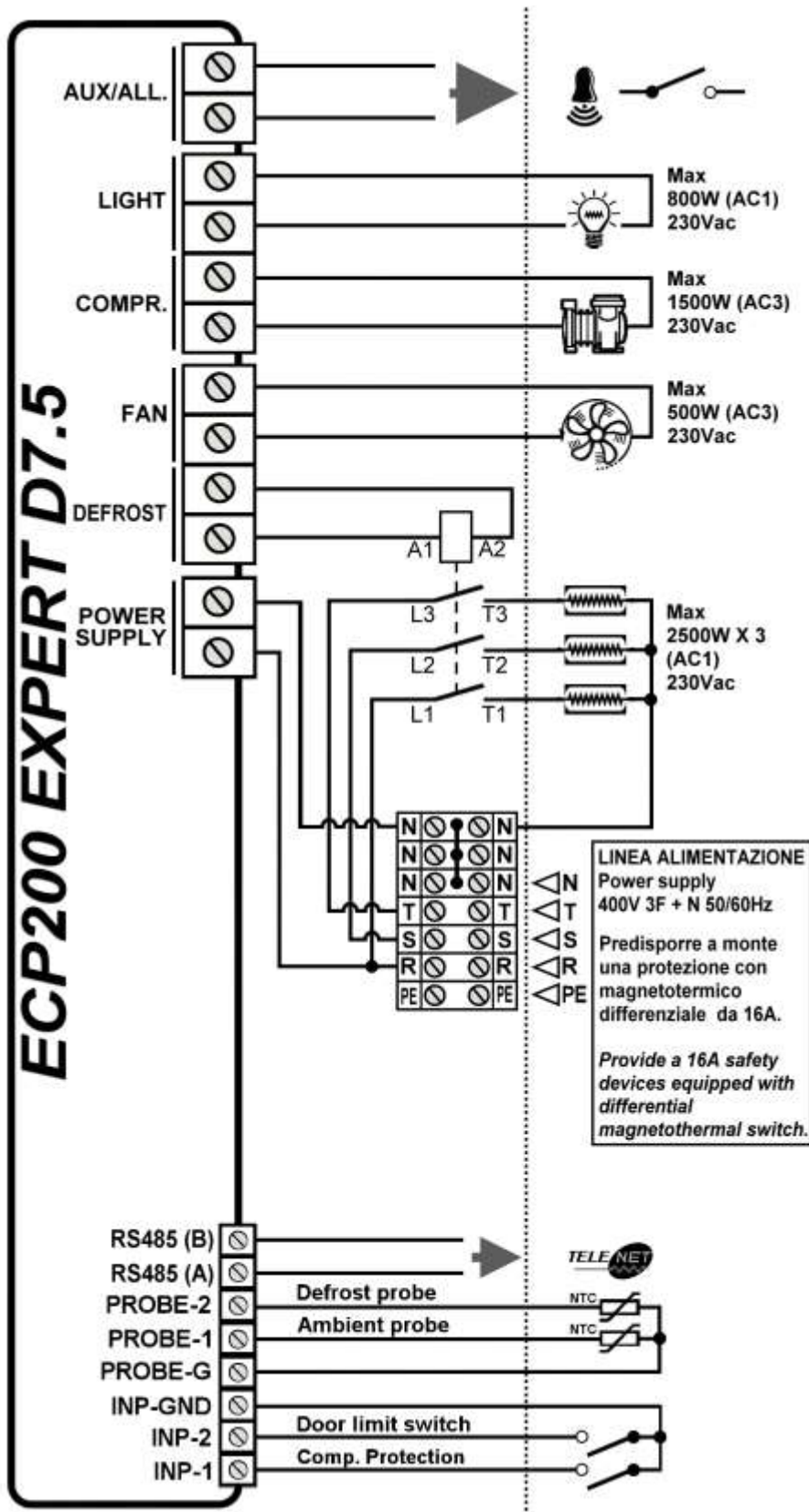

A.3

TeleNET NETWORK CONNECTION WIRING DIAGRAM

BEFORE CONNECTING UP, COMMUTATE THE ALARM RELAY / TELENET SWITCHING FUNCTION VIA DEEP-SWITCH AS INDICATED CAP. 6.3 

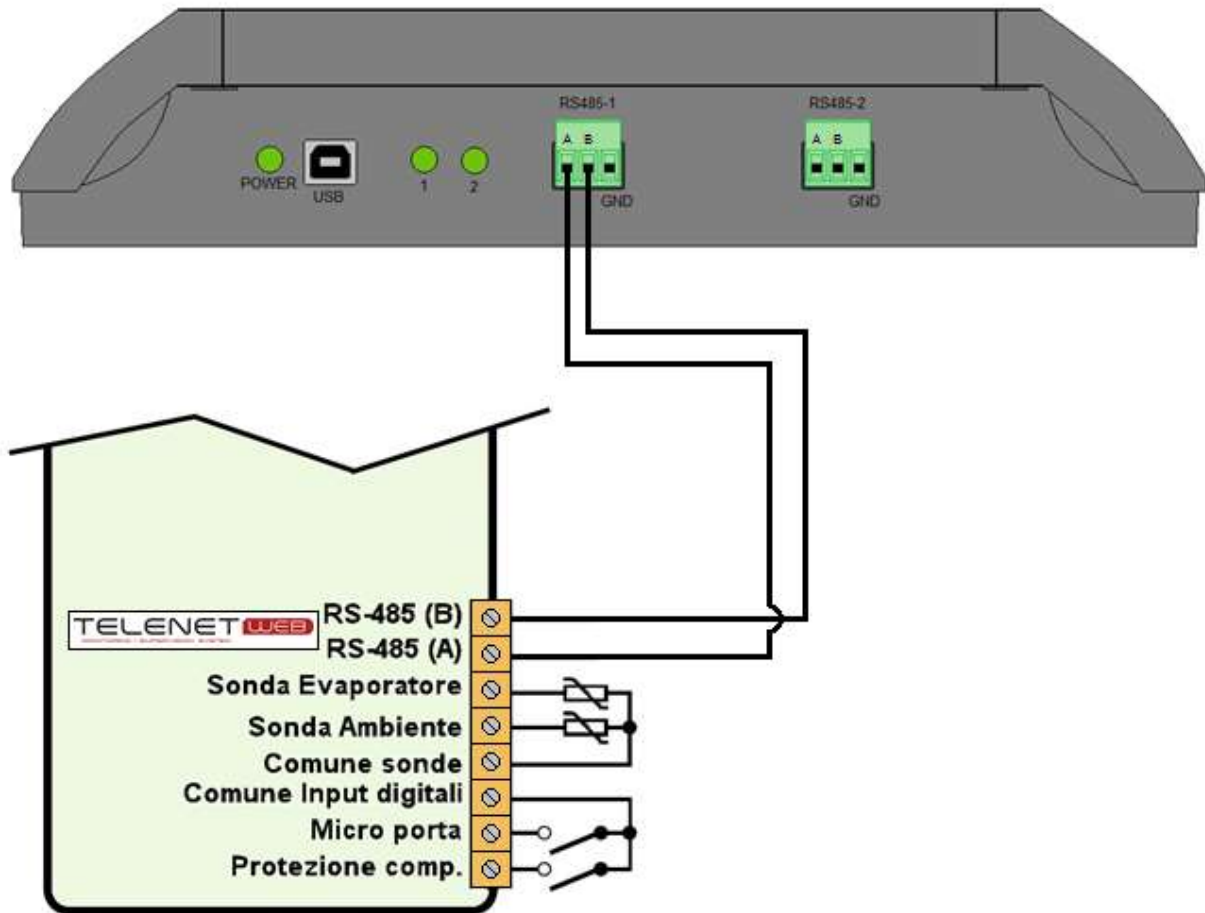

A.4

PART LIST

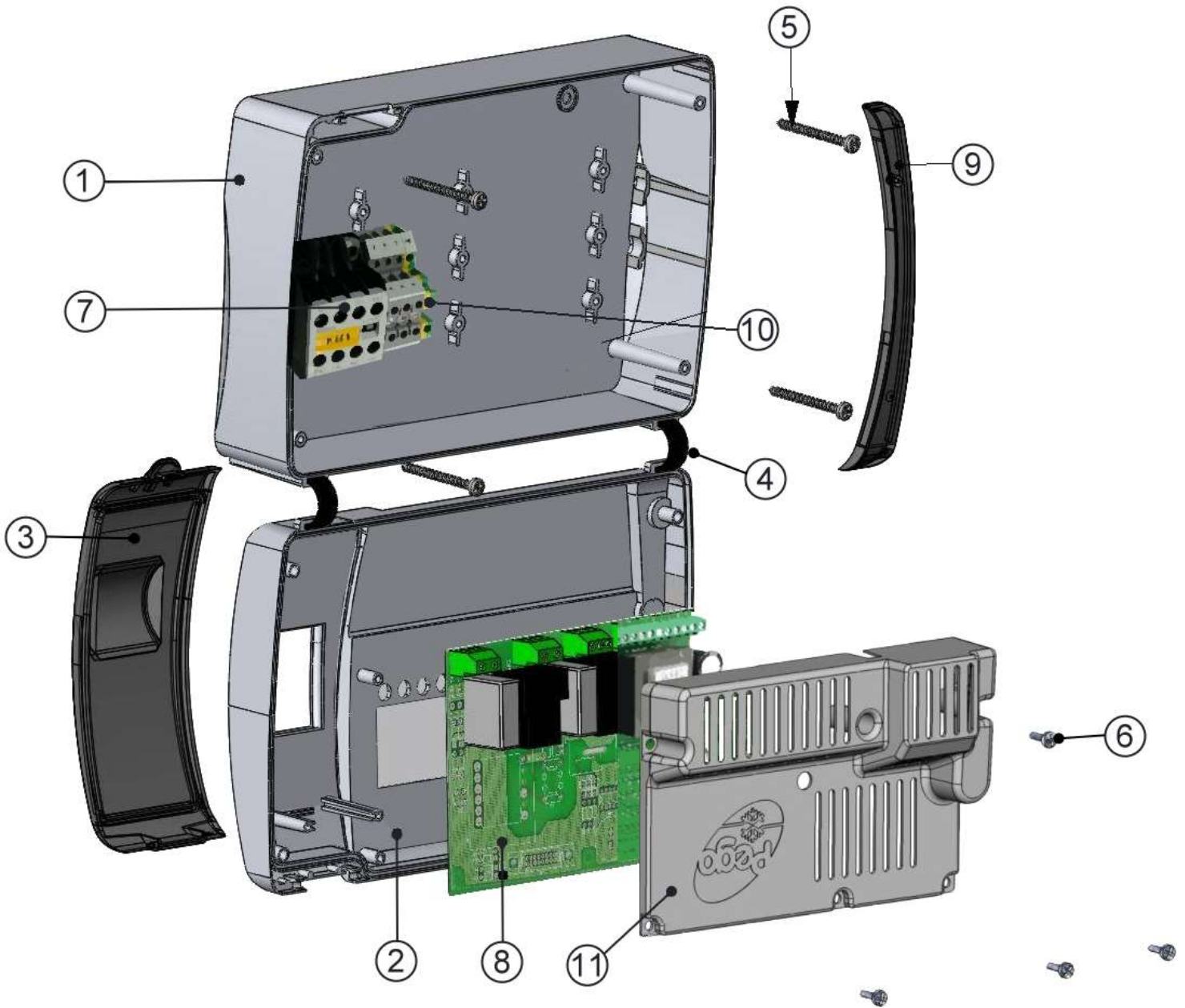

KEY

REF.	DESCRIPTION
1	BOX REAR IN ABS
2	BOX FRONT IN ABS
3	FRONT COVER IN TRANSPARENT POLYCARBONATE
4	BOX FRONT OPENING HINGE
5	BOX CLOSURE SCREWS
6	BOARD FIXING SCREWS
7	DEFROST CONTACTOR
8	CPU BOARD
9	POLYCARBONATE SCREW COVER
10	TERMINAL BLOCK FOR ELECTRICAL PANEL POWER SUPPLY
11	ELECTRICAL BOARD COVER



PEGO s.r.l.
Via Piacentina, 6/b 45030 Occhiobello ROVIGO - ITALY
Tel. +39 0425 762906 Fax +39 0425 762905
e.mail: info@pego.it – www.pego.it

AFTER-SALES ASSISTANCE SERVICE
Tel. +39 0425 762906 e.mail: tecnico@pego.it

Distributor: