

ECP202 EXPERT D7.5



Use and maintenance manual

READ AND KEEP

Rel. Software: 26

CONTENTS

INTRODUCTION

CHAP. 1

Page 4	1.1	General
Page 4	1.2	Product ID codes
Page 5	1.3	Overall dimensions
Page 5	1.4	Identification data

INSTALLATION

CHAP. 2

Page 6	2.1	Important information for the installer
Page 6	2.2	Standard assembly kit
Page 7	2.3	Installing the unit

FUNCTIONS

CHAP. 3

Page 9	3.1	ECP202 EXPERT D7.5 panel functions
--------	-----	------------------------------------

TECHNICAL CHARACTERISTICS

CHAP. 4

Page 10	4.1	Technical characteristics
Page 11	4.2	Warranty terms

PARAMETER PROGRAMMING

CHAP. 5

Page 12	5.1	Control panel
Page 12	5.2	Frontal keypad
Page 13	5.3	LED display
Page 14	5.4	General
Page 14	5.5	Key to symbols
Page 14	5.6	Setting and displaying set points
Page 15	5.7	Level 1 programming
Page 15	5.8	List of Level 1 variables
Page 16	5.9	Level 2 programming
Page 16	5.10	List of Level 2 variables
Page 19	5.11	Switching on the ECP202 EXPERT D7.5 electronic controller
Page 19	5.12	Hot /cold activation/deactivation conditions
Page 19	5.13	Manual defrosting
Page 20	5.14	Defrost with heater and temperature control
Page 20	5.15	Hot gas defrosting
Page 20	5.16	Pump down function
Page 20	5.17	Password protection

OPTIONAL

CHAP. 6

Page 21	6.1	TeleNET monitoring / supervision system
Page 21	6.2	Net configuration with Modbus-rtu protocol

TROUBLESHOOTING

CHAP. 7

Page 22	7.1	Troubleshooting
---------	-----	-----------------

APPENDICES

Page 23	A.1	EU declaration of Conformity
Page 24	A.2	ECP202 EXPERT D7.5 wiring diagram
Page 25	A.3	Part list

CHAPTER 1: INTRODUCTION

1.1

GENERAL

DESCRIPTION:

The **ECP202 EXPERT D7.5** is a new control panel for cold rooms with a single-phase compressor up to 2 HP and three-phase+N electrical defrost up to 7500W (2500W x 3). It allows the user to control all the components on a refrigerating system: compressor, evaporator fans, defrosting elements, room light and thermostat-holder demisting element.

APPLICATIONS:

- Complete management of single-phase static or ventilated refrigeration systems up to 2 HP, with off-cycle or electrical defrosting [up to 7500W (2500W x 3)] and with direct or pump-down compressor stop.
- Control of evaporator unit only with three-phase+N electrical defrost up to 7500W (2500W x 3), with freon solenoid enabling or remote condensing unit enabling.

MAIN CHARACTERISTICS:

- Direct control of defrosting elements, evaporator fans, room light with outputs directly connectable to the various units.
- Three-phase+N electrical defrost up to 7500W (2500W x 3).
- Innovative, smartly designed ABS cover with transparent cover for access to the magneto-thermal cut-out switch, all with an IP65 protection rating so that panel can be used outside the room.
- LED indicators and large display illustrate system status.
- User-friendly keypad.
- Two auxiliary relays configurable by parameter (alarms, temperature set point, direct control via front push-button, thermostat-holder demisting element, remote condensing unit consensus, freon solenoid control in the event of compressor pump-down operation).
- RS485 port for connection to the TeleNET supervision net or to a net with MODBUS-RTU protocol.
- Temperature control to 0.1°C.

1.2

PRODUCT ID CODES

200202EXPD7.5CS

ECP202 EXPERT D7.5

controls and manages compressor, defrosting elements, evaporator fans and room light. Two Aux/Alarms relay. Probes included
Three-phase+N electrical defrost up to 7500W (2500W x 3).

OVERALL DIMENSIONS

1.3

Dimensions in mm



IDENTIFICATION DATA

1.4

The unit described in this manual has an ID plate on the side showing all the relevant identification data:

- Name of Manufacturer
- Code of the unit
- Serial number
- Power supply
- Rated current
- IP protection rating



CHAPTER 2: INSTALLATION

2.1

IMPORTANT INFORMATION FOR THE INSTALLER

1. Install the device in places where the protection rating is observed and try not to damage the box when drilling holes for wire/pipe seats.
2. Do not use multi-polar cables in which there are wires connected to inductive/power loads or signalling wires (e.g. probes/sensors and digital inputs).
3. Do not fit power supply wiring and signal wiring (probes/sensors and digital inputs) in the same raceways or ducts.
4. Minimise the length of connector wires so that wiring does not twist into a spiral shape as this could have negative effects on the electronics.
5. Fit a general protection fuse upstream from the electronic controller.
6. All wiring must be of a cross-section suitable for relevant power levels.
7. When it is necessary to make a probe/sensor extension, the wires must have a cross-section of at least 1mm².
8. To predispose to the source a 16A quadrupole differential magnetothermic protection.

2.2

STANDARD ASSEMBLY KIT

For the purposes of assembly and use, the electronic **ECP202 EXPERT D7.5** control unit comes with:

- Nr 3 seals, to be fitted between the fixing screws and the box back panel;
- Nr 1 user's manual.

INSTALLING THE UNIT

2.3

Fig. 1: Raise the transparent cover that shields the magneto-thermal cut-out switch and remove the screw cover on the right-hand side.



Fig. 2: Undo the 4 fixing screws at the front of the box.



Fig. 3: Close the transparent cut-out switch cover.



Fig. 4: Open the front of the box, lift it and slide the two hinges out as far as they will go.



Fig. 5: Press on the sides of the hinges to remove them from their seats and so remove the front panel completely.



Fig. 6: Use the three existing holes to fix the box back panel to the wall: use three screws of a length suitable for the thickness of the wall to which the panel will be attached. Fit a rubber washer (supplied) between each screw and the box backing.



Fig. 7: Hook the frontal panel back up to the lower part of the box by inserting the two hinges in their seats and, bending them, rotate downwards 180° to gain access to the electronic board.

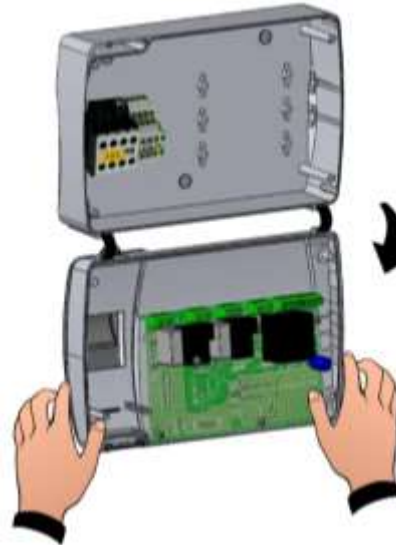

Make all the electrical connections as illustrated in the diagram for the corresponding model (see relative table in APPENDICES). To make electrical connections reliably and maintain the protection rating, use appropriate cable glands and pipepresses to ensure a good seal. It is advisable to distribute the passage of the conductors inside the panel as far as possible, in particular to keep the power leads away from the cables of the signal. Use clips to hold wires in place.



Fig. 8: close the front panel, making sure that all the wires are inside the box and that the box seal sits in its seat properly.
Tighten the front panel using the 4 screws.
Power up the panel and carry out thorough reading/programming of all the parameters.



Be careful not to over-tighten the closure screws as this could warp the box and compromise proper operation of the membrane-type keypad.
Install short-circuit overload safety devices on all the power cables connected to the ECP202 EXPERT D7.5 to prevent damage to the device. Work and/or maintenance must ONLY be carried out on the unit after disconnecting the panel from the power supply and from any inductive/power loads: doing so allows the worker to do his job safely.



CHAPTER 3: FUNCTIONS

3.1

ECP202 EXPERT D7.5 PANEL FUNCTIONS

- Cold room temperature displaying and regulation with decimal point.
- Evaporator temperature with decimal point displaying from parameter.
- Plant control activation/deactivation.
- Plant alarms signaling (probe error, minimum and maximum temperature alarm, compressor protection, door alarm).
- LED indicators and large display illustrate system status.
- User-friendly keypad.
- Evaporator fans management.
- Manual and automatic defrost (static, through heaters, through heaters with temperature control, through cycle reversal).
- Direct or pump-down management and control of condensing unit up to 2HP.
- Cold room light activation through key on the panel or through door-switch.
- Direct control of compressor, defrosting elements, evaporator fans, room light with outputs directly connectable to the various units.
- Air recirculation management.
- 2 auxiliary relays with parameter-configured.
- RS485 to connect to a TeleNET supervision system or a MODBUS-RTU network.
- Emergency operation in the event of a faulty probe environment.
- Smart defrost (energy saving).
- Reduced set (night set) from digital input.
- Can be configured for hot or cold applications.
- Configurable digital inputs.

CHAPTER 4: TECHNICAL CHARACTERISTICS**TECHNICAL CHARACTERISTICS****4.1**

Power supply	
Voltage	400 V~ three phases + neutral $\pm 10\%$ 50-60Hz
Max power (only electronics)	~ 7 VA
Protection to be installed upstream of the power line	Magnetothermic quadripolar differential 16A Curve D (it has to be added by installer)
Cold room conditions	
Working temperature	-5 \div 50°C
Storage temperature	-10 \div 70°C
Relative humidity	Less than 90% UR
General characteristics	
Type of sensors that can be connected	NTC 10K 1%
Resolution	0,1°C
Sensor read precision	$\pm 0,5^\circ\text{C}$
Read range	-45...+45 °C
ECP202 EXPERT D7.5 - Output characteristics - max applicable load (230VAC)	
Compressor	1500W (AC3) Single-phase
Elements	7500W (2500W 230V x 3) (AC1) Threephases+N
Fans	500W (AC3) Single-phase
Room light	800W (AC1) Single-phase
Aux 1 (free voltage contact)	100W
Aux 2 (free voltage contact)	100W
Dimensional characteristics	
Dimensions	18cm x 9.6cm x 26.3cm (HxPxL)
Insulation / mechanical characteristics	
Box protection rating	IP65
Box material	Self-extinguishing ABS
Type of insulation	Class II

4.2

WARRANTY

The **ECP202 EXPERT D7.5** series products are covered by a 24-months warranty against all manufacturing defects as from the date indicated on the product ID code.

In case of defect the product must be appropriately packaged and sent to our production plant or to any authorized Service Center with the prior request of the Return Authorization Number.

Customers are entitled to have defective products repaired, spare parts and labour included. The costs and the risks of transport are at the total charge of the Customer.

Any warranty action does not extend or renew its expiration.

The Warranty does not cover:

- Damages resulting from tampering, impact or improper installation of the product and its accessories.
- Installation, use or maintenance that does not comply with the instructions provided with the product.
- Repair work carried out by unauthorized personnel.
- Damage due to natural phenomena such as lightning, natural disasters, etc...

In all these cases the costs for repair will be charged to the customer.

The intervention service in warranty can be refused when the equipment is modified or transformed.

Under no circumstances **Pego S.r.l.** will be liable for any loss of data and information, costs of goods or substitute services, damage to property, people or animals, loss of sales or earnings, business interruption, any direct, indirect, incidental, consequential, damaging, punitive, special or consequential damages, in any way whatsoever caused, whether they are contractual, extra contractual or due to negligence or other liability arising from the use of the product or its installation.

Malfunction caused by tampering, bumps, inadequate installation automatically declines the warranty. It is compulsory to observe all the instructions in this manual and the operating conditions of the product.

Pego S.r.l. disclaims any liability for possible inaccuracies contained in this manual if due to errors in printing or transcription.

Pego S.r.l. reserves the right to make changes to its products which it deems necessary or useful without affecting its essential characteristics.

Each new release of the Pego product user manual replaces all the previous ones.

As far as not expressly indicated, is applicable the Law and in particular the art. 1512 C.C. (Italian Civil Code).

For any controversy is elected and recognized by the parties the jurisdiction of the Court of Rovigo.

CHAPTER 5: PARAMETER PROGRAMMING







CONTROL PANEL









5.1



FRONT KEYPAD

5.2

- 1

AUXILIARY RELAY CONTROL
 (controls the relays manual if parameter AU1/AU2 = 2/-2)
- 2

UP / MUTE BUZZER ALARM
- 3

STAND BY (if the system shuts down the LED flashes)
- 4

room temperature SETTING
- 5

DOWN / MANUAL DEFROST
- 6

ROOM LIGHT

- 7 Cold room temperature / parameters
- 8  Stand-by (flashes on stand-by. Outputs are deactivated)
- 9  Room light (flashes if door switch activated)
- 10  Cold (indicates activation of compressor)
- 11  Fans
- 12  Defrosting
- 13 **AUX** Auxiliary (indicates AUX relay calling if AU1/AU2= \pm 2 or \pm 3)
- 14  Alarm/warning
- 15  Decimal point (flashing in night mode)
- 16  Hot mode (resistance call signaling)

5.4

GENERAL



To enhance safety and simplify the operator's work, the **ECP202 EXPERT D7.5** has two programming levels; the first level (Level 1) is used to configure the frequently-modified **SETPOINT** parameters. The second programming level (Level 2) is for general parameter programming of the various controller work modes.

It is not possible to access the Level 2 programming directly from Level 1: you must exit the programming mode first.

5.5

KEY TO SYMBOLS

For purposes of practicality the following symbols are used:

- (▲) the UP key  is used to increase values and mute the alarm.
- (▼) the DOWN key  is used to decrease values and force defrosting.

5.6

SETTING AND DISPLAYING THE SET POINTS

1. Press the **SET key** to display the current **SETPOINT** (temperature).
2. Hold down the **SET key** and press the (▲) or (▼) keys to modify the **SETPOINT**. Release the **SET key** to return to cold room temperature display: the new setting will be saved automatically.

LEVEL 1 PROGRAMMING (User level)

5.7

To gain access to the Level 1 configuration menu proceed as follows:

1. Press the (\blacktriangle) and (\blacktriangledown) keys simultaneously and keep them pressed for a few seconds until the first programming variable appears on the display.
2. Release the (\blacktriangle) and (\blacktriangledown) keys.
3. Select the variable to be modified using the (\blacktriangle) or (\blacktriangledown) key.
4. When the variable has been selected it is possible:
 - to display the setting by pressing SET key.
 - to modify the setting by pressing the SET key together with the (\blacktriangle) or (\blacktriangledown) key.

When configuration values have been set you can exit the menu by pressing the (\blacktriangle) and (\blacktriangledown) keys simultaneously for a few seconds until the cold room temperature reappears.

The new settings are saved automatically when you exit the configuration menu.

5.8

LIST OF LEVEL 1 VARIABLES (User level)

VARIABLES	MEANING	VALUE	DEFAULT
r0	Temperature difference compared to main SETPOINT	0,2 – 10,0 °C	2,0 °C
d0	Defrost interval (hours) If d0 = 0 cyclical defrosts Off	0 ÷ 24 hours	4 hours
d2	End-of-defrost setpoint. Defrost is not executed if the temperature read by the defrost sensor is greater than d2. (If the sensor is faulty defrosting is timed)	-35 ÷ 45 °C	15°C
d3	Max defrost duration (minutes)	1 ÷ 240 min	25 min
d7	Drip duration (minutes) At the end of defrost the compressor and fans remain at standstill for time d7, the defrost LED on the front panel flashes.	0 ÷ 10 min	0 min
F5	Fan pause after defrost (minutes) Allows fans to be kept at standstill for a time F5 after dripping. This time begins at the end of dripping. If no dripping has been set the fan pause starts directly at the end of defrost.	0 ÷ 10 min	0 min
A1	Minimum temperature alarm Allows user to define a minimum temperature for the room being refrigerated. Below value A1 an alarm trips: the alarm LED flashes, displayed temperature flashes and the buzzer sounds to indicate the problem.	-45÷(A2-1) °C	-45°C
A2	Maximum temperature alarm Allows user to define a maximum temperature for the room being refrigerated. Above value A2 an alarm trips: the alarm LED flashes, displayed temperature flashes and the buzzer sounds to indicate the problem.	(A1+1)÷99 °C	+99°C
tEu	Evaporator sensor temperature display (displays nothing if dE =1)	evaporator temperature	read only

LEVEL 2 PROGRAMMING (Installer level)

5.9

To gain access to the second Level configuration menu proceed as follows:

1. Press the UP (▲) and DOWN (▼) keys and the LIGHT key simultaneously for a few seconds. When the first programming variable appears the system automatically goes to stand-by.
2. Select the variable to be modified by pressing the UP (▲) and DOWN (▼) keys. When the parameter has been selected it is possible to:
 - View the setting by pressing the SET key.
 - Modify the setting by holding the SET key down and pressing the (▲) or (▼) key.

When configuration settings have been completed you can exit the menu by pressing the (▲) and (▼) keys simultaneously and keeping them pressed until the room temperature reappears.

Changes are saved automatically when you exit the configuration menu.

3. Press the STAND-BY key to enable electronic control.

LIST OF LEVEL 2 VARIABLES (Installer level)

5.10

VARIABLES	MEANING	VALUES	DEF.
F3	Fan status with compressor off	0 = Fans run continuously 1 = Fans only run when compressor is working 2 = Fans disabled	1
F4	Fan pause during defrost	0 = Fans run during defrost 1 = Fans do not run during defrost	1
F6	Evaporator fans activation for air recirculation. The fans activate for a time defined by F7 if they have not started working for the F6 time. If activation time coincides with the defrosting time, end of defrosting is awaited.	0 – 240 min 0 = (function not activated)	0 min
F7	Evaporator fans duration for air recirculation. Fans working time for F6	0-240 seconds	10 sec
dE	Sensor presence If the evaporator sensor is disabled defrosts are carried out cyclically with period d0: defrosting ends when an external device trips and closes the remote defrost contact or when time d3 expires.	0 = evaporator sensor present 1 = no evaporator sensor	0
d1	Defrost type , cycle inversion (hot gas) or with heater elements	0 = heating element 1 = hot gas 2 = heater with temperature control	0
dPo	Defrost at Power On	0 = disabled 1 = defrost at power-on (if possible)	0
dSE	Smart defrost	0 = disabled 1 = enabled	0
dSt	Smart defrost Setpoint (if dSE=1) The counting of the time between the defrost is incremented only if the compressor is ON and the evaporator temperature is less than dSt.	-30 ÷ 30 °C	1 °C

dFd	Display viewing during Defrost	0 = current temperature 1 = temperature at the start of the defrost 2 = "DEF"	1
Ad	Net address for connection to TeleNET supervision system or Modbus	0 ÷ 31 (con SEr=0) 1 ÷ 247 (con SEr=1)	0
SEr	RS-485 communication protocol	0 = TeleNET protocol 1 = Modbus-RTU protocol	0
Bdr	Modbus baudrate	0 = 300 baud 3 = 2400 baud 6 = 14400 baud 1 = 600 baud 4 = 4800 baud 7 = 19200 baud 2 = 1200 baud 5 = 9600 baud 8 = 38400 baud	5
Prt	Modbus parity check	0 = none 1 = even 2 = odd	0
Ald	Minimum and maximum temperature signalling and alarm display delay	0 ÷ 240 min	120 min
C1	Minimum time between shutdown and subsequent switching on of the compressor.	0 ÷ 15 min	0 min
CAL	Cold room sensor value correction	-10,0 ÷ +10,0 °C	0,0 °C
CE1	Duration of compressor ON time in the case of faulty ambient probe (emergency mode). If CE1=0 the emergency mode in the presence of error E0 remains disabled, the compressor remains off and defrosting is prevented in order to conserve the remaining cold.	0 ÷ 240 min 0 = disabled	0 min
CE2	Duration of compressor OFF time in the case of faulty ambient probe. (emergency mode).	5 ÷ 240 min	5 min
doC	Compressor safety time for door switch: when the door is opened the evaporator fans shut down and the compressor will continue working for time doC, after which it will shut down.	0 ÷ 5 min	0 min
tdo	Compressor restart time after door opening. When the door is opened and after tdo time, it's setted back the normal functioning giving door open alarm (Ed) If the door switch is closed and the light stays on for a longer time than tdo light cell alarm is signaled (E9). With tdo=0 the parameter is disabled.	0 ÷ 240 min 0 = disabled	0 min
Fst	FAN shutdown TEMPERATURE The fans will stop if the temperature value read by the evaporator sensor is higher than this value.	-45 ÷ +99 °C	+99 °C
Fd	Fst differential	1 ÷ +10 °C	2 °C
LSE	Minimum value attributable to setpoint.	-45 ÷ (HSE-1) °C	-45 °C
HSE	Maximum value attributable to setpoint.	(LSE+1) ÷ +99°C	+99 °C

AU1	Auxiliary/alarm relay 1 control	<p>-6 (NC) = relay de-energised during stand-by</p> <p>-5 (NC) = Contact for casing element control (AUX relay closed with compressor output inactive).</p> <p>-4 (NC) = pump down function (NC, see CHAP 5.16)</p> <p>-3 (NC) = automatic auxiliary relay managed by StA temp. setting with 2°C differential (NC)</p> <p>-2 (NC) = manual auxiliary relay controlled via AUX key (NC)</p> <p>-1 (NC) = alarm relay (NC)</p> <p>0 = relay deactivated</p> <p>1 (NO) = alarm relay (NO)</p> <p>2 (NO) = manual auxiliary relay controlled via AUX key (NO)</p> <p>3 (NO) = automatic auxiliary relay managed by StA temp. setting with 2°C differential (NO)</p> <p>4 (NO) = pump down function (NO, see CHAP 5.16)</p> <p>5 (NO) = free voltage contact for condensing unit (AUX relay and compressor relay in parallel)</p> <p>6 (NO) = relay excited during stand-by</p>	-1
AU2	Auxiliary/alarm relay 2 control	(like AU1)	5
StA	Temperature setting for auxiliary relay	-45 ÷ +99°C	0 °C
nSC	<p>Correction factor for the SET button during night operation (energy saving) (with In1 or In2 = 8 or -8)</p> <p>During night operation the control set is: Set Control = Set + nSC</p> <p>In night mode decimal point flashes.</p>	-20,0 ÷ +20,0 °C	0,0 °C
In1	INP-1 input setting	<p>8 = Night mode digital input (energy saving, N.O.)</p> <p>7 = Stop defrosting remotely (N.O.) (reads rising edge of impulse)</p> <p>6 = Start defrosting remotely (N.O.) (reads rising edge of impulse)</p> <p>5 = Stand-by remotely (N.O.) (In order to indicate Stand-By mode, the display shows 'In5' alternating with the current view)</p> <p>4 = Pump-down pressure switch (N.O.)</p> <p>3 = Man-in-room alarm (N.O.)</p> <p>2 = Compressor protection (N.O.)</p> <p>1 = Door switch (N.O.)</p> <p>0 = disabled</p> <p>-1 = Door switch (N.C.)</p> <p>-2 = Compressor protection (N.C.)</p> <p>-3 = Man-in-room alarm (N.C.)</p> <p>-4 = Pump-down pressure switch (N.C.)</p> <p>-5 = Stand-by remotely (N.C.) (In order to indicate Stand-By mode, the display shows 'In5' alternating with the current view)</p> <p>-6 = Start defrosting remotely (N.C.) (reads falling edge of impulse)</p> <p>-7 = Stop defrosting remotely (N.C.) (reads falling edge of impulse)</p> <p>-8 = Night mode digital input (energy saving, N.C.)</p>	2
In2	INP-2 input setting	(like In1)	1

bEE	Buzzer enable	0 = disabled 1 = enabled	1
mOd	Thermostat functioning mode	0 = Cold function 1 = Hot function (in this mode defrosting and fan disable Fst are excluded)	0
P1	Password type of protection (active when PA is not equal 0)	0 = only display set point 1 = display set point, AUX, light access 2 = access in programming not permitted 3 = access in second level programming not permitted	3
PA	Password (see P1 for the type of protection)	0...999 0 = not active	0
reL	release software	indicates software version	26 (read only)

SWITCHING ON THE ECP202 EXPERT D7.5 ELECTRONIC CONTROLLER

5.11

After wiring the electronic controller correctly, power up at 230 V AC; the display panel will immediately emit a beep and all the LEDs will come on simultaneously for a few seconds.

COMPRESSOR ACTIVATION/DEACTIVATION CONDITIONS

5.12

In cold mode (mOd=0), the **ECP202 EXPERT D7.5** controller activates the compressor when cold room temperature exceeds setting+differential (r0); it deactivates the compressor when cold room temperature is lower than the setting.

If Pump-Down function is selected (Parameter AU1/AU2 = 4/-4), see chapter 5.16 for compressor activation/deactivation conditions.

In hot mode (mOd=1), the **ECP202 EXPERT D7.5** controller activates the heat output (COMPR output) when cold room temperature drops below setting-differential (r0); it deactivates the heat output (COMPR output) when cold room temperature is higher than the setting.

MANUAL DEFROSTING

5.13

To defrost just press the dedicated key (see section 5.2) to activate the elements relay. Defrosting will not take place if the end-of-defrost temperature setting (d2) is lower than the temperature detected by the evaporator sensor. Defrosting ends when the end-of-defrost temperature (d2) or maximum defrost time (d3) is reached, or due to forced manual defrost termination (end of defrost button or digital input).

5.14**DEFROST WITH HEATER AND TEMPERATURE CONTROL**

Set the parameter d1=2 for the management of heater defrost by time with temperature control. During the defrost the output is activated when the evaporator's temperatures are lower than d2. Defrost stops after d3 minutes. It allows energy saving and a better defrost process.

5.15**HOT GAS DEFROSTING**

Set parameter d1=1 to defrost in cycle inversion mode.

The compressor relay and defrost relay are activated throughout the defrost phase.

To ensure proper control of the system the installer must use the defrost output: this must allow opening of the cycle inversion solenoid valve and closure of the liquid solenoid valve. For capillary systems (without thermostat valve) it is only necessary to control the cycle inversion solenoid valve via the defrost relay control.

5.16**PUMP DOWN FUNCTION**

Pump down function is activated when parameter AU1/AU2 = 4 / -4.

Connect pump down pressostat on the digital input configured as pump down (In1 or In2 = 4 / -4). The compressor is directly controlled by pressostat. Connect evaporator solenoid valve on the AUX1 (or AUX2) relay. The solenoid is controlled directly by thermostat.

5.17**PASSWORD FUNCTION**

When parameter PA is setting with value different to 0 the protection function is activated.

See parameter P1 for the different protection.

When PA is setting the protection start after two minutes of inactivity. On display appear 000. With up/down modify the number, with set key confirm it.

Use universal number 100 if you don't remember the password.

CHAPTER 6: OPTIONAL KITS

6.1

TeleNET MONITORING/SUPERVISION SYSTEM

For **TeleNET** connections follow the scheme below. For electrical connections see Annex **A.2** on page 24 of this manual.

WARNING: During configuration, at entry "Module" to select the entry "Instrument ECP Base Series / ECP Expert Series rel. 25 or higher".



6.2

NET CONFIGURATION WITH MODBUS-RTU PROTOCOL

For **RS485** connections with **Modbus-RTU** protocol follow the scheme below. Refer to MODBUS-RTU_ECP202EXP user manual for MODBUS-RTU communication protocol specification.

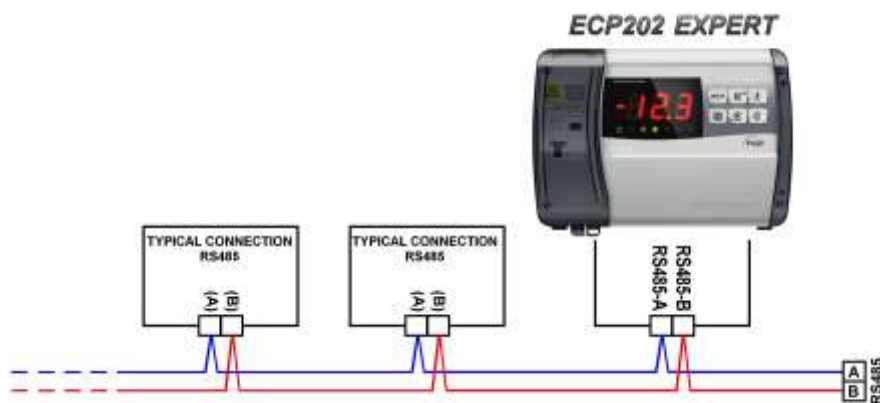

CHAPTER 7: TROUBLESHOOTING

7.1

TROUBLESHOOTING

In the event of any anomalies the **ECP202 EXPERT D7.5** in case of anomalies, it notifies the operator by means of the alarm codes displayed on the display and an audible signal emitted by a buzzer inside the control panel. The EL and EH temperature alarms remain visible even after their return (alarm icon lights on) until their acquisition (by pressing the key tacit). If an alarm condition occurs, one of the following messages will be displayed on the display:

ALARM CODE	POSSIBLE CAUSE	SOLUTION
E0	Cold room temperature sensor not working properly	<ul style="list-style-type: none"> • Check that cold room temperature sensor is working properly • If the problem persists replace the sensor
E1	Defrost sensor not working properly (In this case defrosts will last time d3)	<ul style="list-style-type: none"> • Check that defrost sensor is working properly • If the problems persists replace the sensor
E2	Eeprom alarm An EEPROM memory alarm has been detected (All outputs except the alarm one are deactivated)	<ul style="list-style-type: none"> • Switch unit off and back on
E8	Man in cold room alarm	<ul style="list-style-type: none"> • Reset the alarm input inside the cold room
Ec	Compressor protection tripped (e.g. thermal protection or max pressure switch) (All outputs except the alarm one – where applicable – are deactivated)	<ul style="list-style-type: none"> • Check that compressor is working properly • Check compressor absorption • If the problem persists contact the technical assistance service
Ed	Open door Alarm. When the door is opened and after tdo time, it's settled back the normal functioning giving door open alarm (Ed)	<ul style="list-style-type: none"> • Check door switch status • Check door switch connections • If the problem persists contact the technical assistance service
E9	Cell light alarm. The light of the cell has been on for a time greater than tdo.	<ul style="list-style-type: none"> • Turn off the light
EH	Maximum temperature alarm. The temperature inside the cold room has exceeded the max. temperature alarm setting (see variables A2, user programming level)	<ul style="list-style-type: none"> • Check that the compressor is working properly. • Sensor not reading temperature properly or compressor start/stop control not working.
EL	Minimum temperature alarm. The temperature inside the cold room has exceeded the min. temperature alarm setting (see variables A1, user programming level)	<ul style="list-style-type: none"> • Check that the compressor is working properly. • Sensor not reading temperature properly or compressor start/stop control not working.

APPENDICES

A.1

EU DECLARATION OF CONFORMITY

LA PRESENTE DICHIARAZIONE DI CONFORMITA' E' RILASCIATA SOTTO LA RESPONSABILITA' ESCLUSIVA DEL FABBRICANTE:
THIS DECLARATION OF CONFORMITY IS ISSUED UNDER THE EXCLUSIVE RESPONSIBILITY OF THE MANUFACTURER:



PEGO S.r.l. Via Piacentina 6/b, 45030 Occhiobello (RO) – Italy –

DENOMINAZIONE DEL PRODOTTO IN OGGETTO / DENOMINATION OF THE PRODUCT IN OBJECT

MOD.: ECP202 EXPERT D7.5

IL PRODOTTO DI CUI SOPRA E' CONFORME ALLA PERTINENTE NORMATIVA DI ARMONIZZAZIONE DELL'UNIONE EUROPEA:
THE PRODUCT IS IN CONFORMITY WITH THE RELEVANT EUROPEAN HARMONIZATION LEGISLATION:

Direttiva Bassa Tensione (LVD):	2014/35/UE
Low voltage directive (LVD):	2014/35/EU
Direttiva EMC:	2014/30/UE
Electromagnetic compatibility (EMC):	2014/30/EU

LA CONFORMITA' PRESCRITTA DALLA DIRETTIVA E' GARANTITA DALL'ADEMPIMENTO A TUTTI GLI EFFETTI DELLE SEGUENTI NORME:
THE CONFORMITY REQUIRED BY THE DIRECTIVE IS GUARANTEED BY THE FULFILLMENT TO THE FOLLOWING STANDARDS:

Norme armonizzate: EN 60730-1:2016, EN 60730-2-9:2010, EN 61000-6-1:2007, EN 61000-6-3:2007
European standards: EN 60730-1:2016, EN 60730-2-9:2010, EN 61000-6-1:2007, EN 61000-6-3:2007

IL PRODOTTO E' COSTITUITO PER ESSERE INCORPORATO IN UNA MACCHINA O PER ESSERE ASSEMBLATO CON ALTRI MACCHINARI PER COSTITUIRE UNA MACCHINA CONSIDERATE DALLA DIRETTIVA: 2006/42/CE "Direttiva Macchine".
THE PRODUCT HAS BEEN MANUFACTURED TO BE INCLUDED IN A MACHINE OR TO BE ASSEMBLED TOGETHER WITH OTHER MACHINERY TO COMPLETE A MACHINE ACCORDING TO DIRECTIVE: EC/2006/42 "Machinery Directive".

Firmato per nome e per conto di:
Signed for and on behalf of:

Pego S.r.l.
Lisa Zampini
Procuratore Generale

Luogo e Data del rilascio:
Place and Date of Release:

Occhiobello (RO), 08/01/2018

ECP202 EXPERT D7.5 WIRING DIAGRAM

A.2

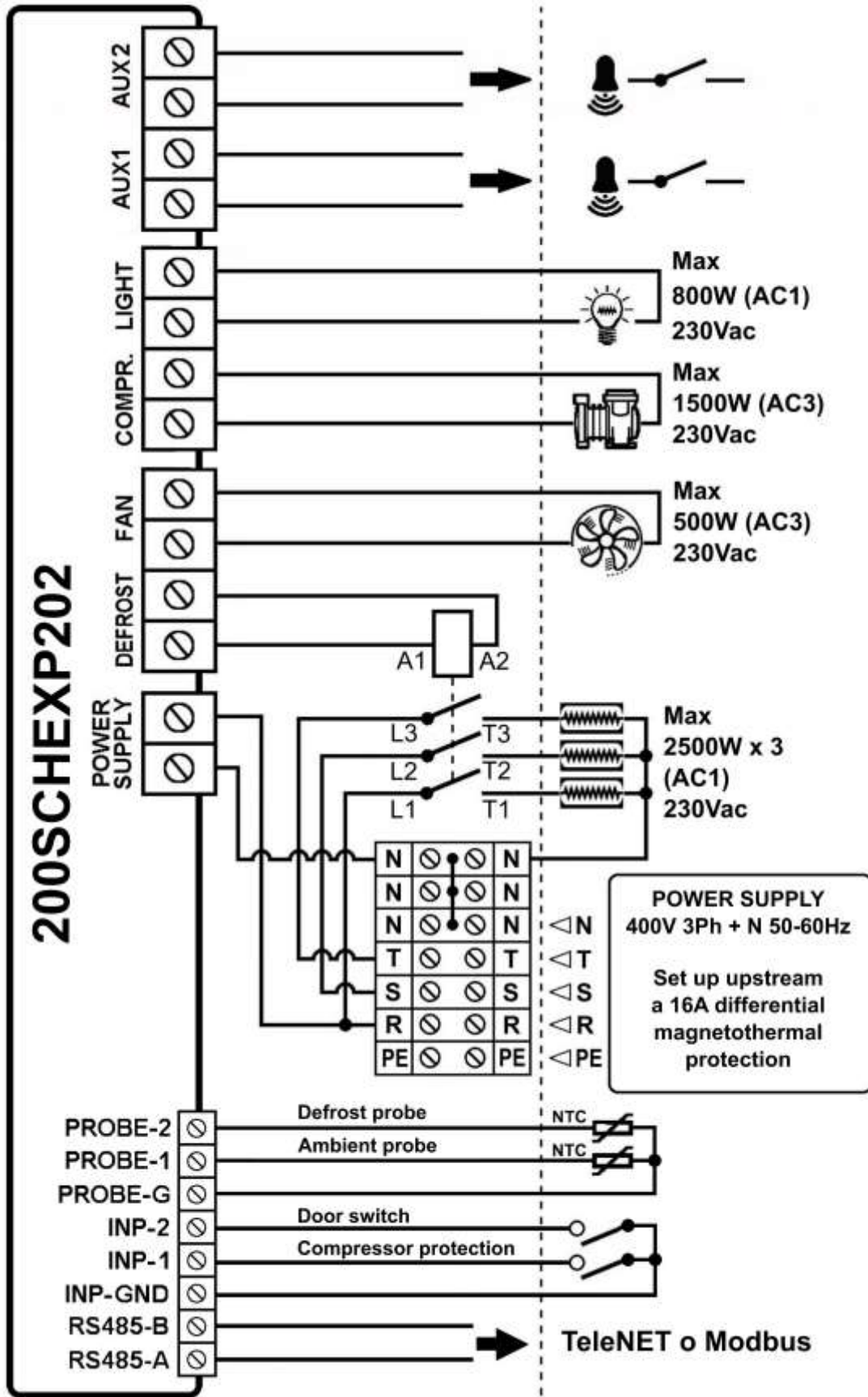

A.3

PART LIST

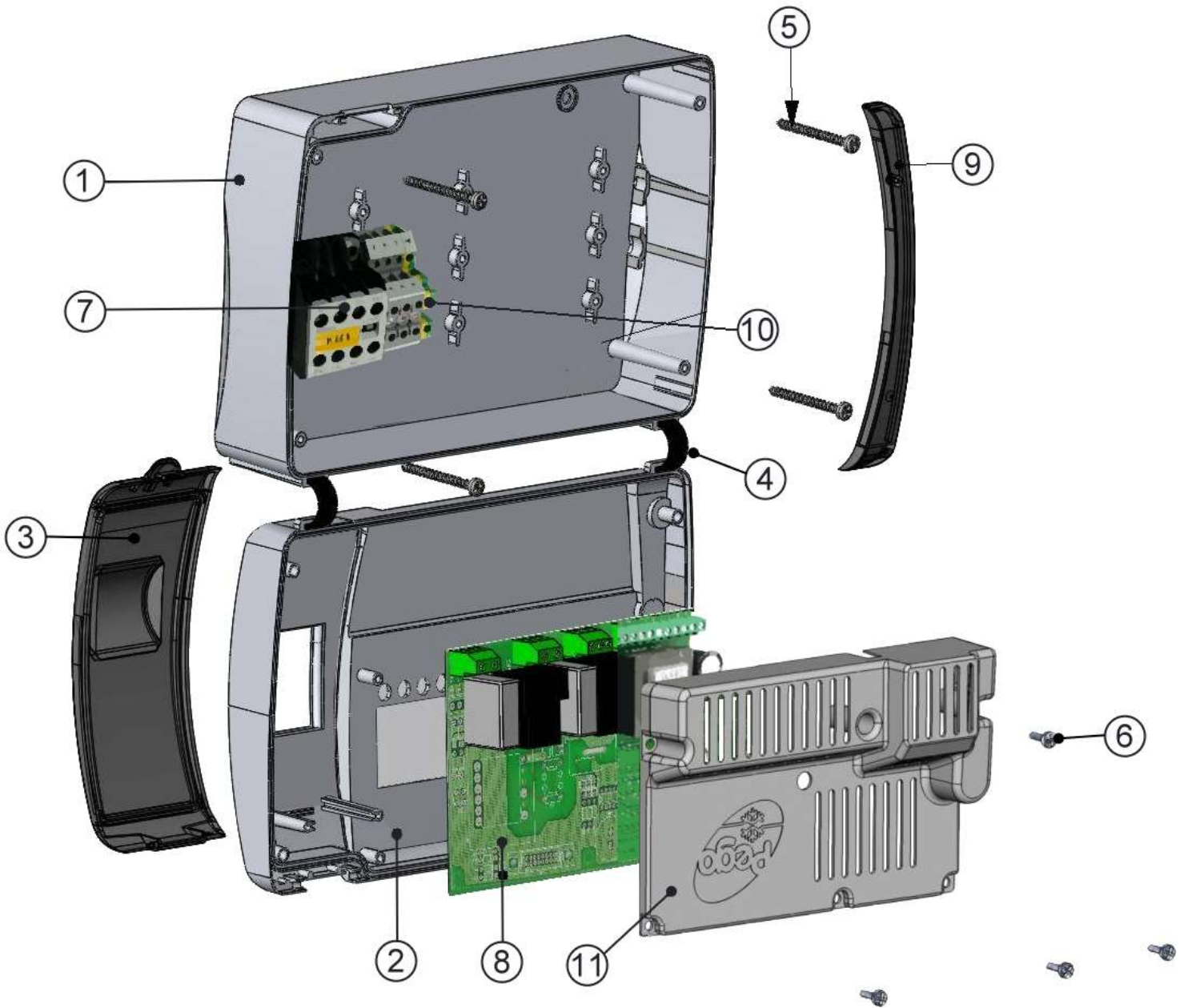

KEY

REF.	DESCRIPTION
1	BOX REAR IN ABS
2	BOX FRONT IN ABS
3	FRONT COVER IN TRANSPARENT POLYCARBONATE
4	BOX FRONT OPENING HINGE
5	BOX CLOSURE SCREWS
6	BOARD FIXING SCREWS
7	DEFROST CONTACTOR
8	CPU BOARD
9	POLYCARBONATE SCREW COVER
10	TERMINAL BLOCK FOR ELECTRICAL PANEL POWER SUPPLY
11	ELECTRICAL BOARD COVER



PEGO s.r.l.
Via Piacentina, 6/b 45030 Occhiobello ROVIGO - ITALY
Tel. +39 0425 762906 Fax +39 0425 762905
e.mail: info@pego.it – www.pego.it

AFTER-SALES ASSISTANCE SERVICE
Tel. +39 0425 762906 e.mail: tecnico@pego.it

Distributor: