

ECP200 EXPERT 2EV



User and maintenance manual

READ AND KEEP

ENGLISH

CONTENTS

INTRODUCTION

CHAP. 1

Page 3	1.1	General
Page 4	1.2	Product identification codes
Page 4	1.3	Overall dimensions
Page 4	1.4	Identification data

INSTALLATION

CHAP. 2

Page 5	2.1	General installation rules
Page 5	2.2	Standard equipment for mounting and use
Page 6	2.3	Board installation

TECHNICAL CHARACTERISTICS

CHAP. 3

Page 8	3.1	Technical characteristics
--------	-----	---------------------------

TERMS OF THE WARRANTY

CHAP. 4

Page 9	4.1	Terms of the warranty
--------	-----	-----------------------

DATA PROGRAMMING

CHAP. 5

Page 10	5.1	The control panel
Page 10	5.2	The front keypad
Page 11	5.3	LED display
Page 12	5.4	General
Page 12	5.5	Symbols
Page 12	5.6	Configuring and reading the set point
Page 13	5.7	Level one programming
Page 13	5.8	List of level one variables
Page 15	5.9	Level two programming
Page 15	5.10	List of level two variables
Page 18	5.11	HACCP alarm management
Page 19	5.12	Starting up the ECP200 EXPERT 2EV electronic controller
Page 19	5.13	Configurations
Page 19	5.14	Conditions for enabling / disabling the compressor
Page 19	5.15	Manual activation of the defrosting process
Page 20	5.16	Stopping the defrosting process manually
Page 20	5.17	Defrosting with hot gas
Page 20	5.18	The Pump-Down function
Page 21	5.19	The password function
Page 21	5.20	Emergency operation in the event of a broken ambient sensor (EO)
Page 21	5.21	Current date and time

OPTIONS

CHAP. 6

Page 22	6.1	TeleNET supervision / monitoring system
---------	-----	---

DIAGNOSTICS

CHAP. 7

Page 23	7.1	Diagnostics
---------	-----	-------------

ANNEXES

Page 24	A.1	EU declaration of Conformity
Page 25	A.2	ECP200 EXPERT 2EV connection diagram
Page 26	A.3	Exploded diagram

CHAPTER 1: INTRODUCTION

GENERAL

1.1

DESCRIPTION:

The **ECP200 EXPERT 2EV** is the new electrical board for cold rooms with single-phase compressor up to 2HP and up to 2 evaporating units.

It allows complete control of all the components on a refrigeration system such as the compressor, the evaporator fans, defrosting element 1, defrosting element 2, room light and configurable auxiliary relay.

APPLICATIONS:

- Room with single motor condenser up to 2HP and double evaporating unit.
- Complete control of single-phase static or ventilated refrigeration systems up to 2HP, with off-cycle or electrical defrosting and direct or pump-down compressor stop.
- Control of evaporating unit only with freon solenoid consensus or remote motor condenser consensus.

MAIN CHARACTERISTICS:

- Reading and configuration of the room temperature to one decimal point.
- Displays temperature parameter of evaporator 1 and 2.
- Activation/deactivation of the system controller (stand-by).
- Signalling of system alarms.
- System status LEDs and large display.
- Easy to use keypad.
- Control of the evaporator fans.
- Real time clock defrosts with one or two evaporators, each with end-of-defrost sensor.
- Automatic and manual defrost control (static, with elements, with cycle inversion).
- Management and control (direct or in pump-down mode) of the compressor up to 2HP.
- Button on board or door switch for turning on the room light.
- Alarm/auxiliary relay with parameter-configured activation.
- Advanced HACCP function with detailed registration of the last temperature alarm to have occurred, and counter for previous alarms.
- Integrated differential thermal magnetic circuit breaker for protecting and turning off the power to the refrigerating unit (to make the protection effective, derive the power supply of the utilities downstream of the differential thermal magnetic circuit breaker).
- Self-extinguishing ABS cover with transparent door for accessing the thermal magnetic differential protection with IP65 protection, for use as a board outside the room.
- RS485 output for connection to TeleNET supervision network.

1.2

PRODUCT IDENTIFICATION CODES

200200EXP2EV

ECP200 EXPERT 2EV

Compressor control and management, evaporator 1 defrost, evaporator 2 defrost, evaporator fans and room light. Alarm/aux relay. Real time clock.

16A differential thermal magnetic circuit breaker
Id=300mA

1.3

OVERALL DIMENSIONS

Dimensions in mm



1.4

IDENTIFICATION DATA

There is a plate on the device in question that states the identification data:

- Name of the manufacturer
- Code of the electrical board
- Serial number
- Power supply
- Max rated current
- IP protection

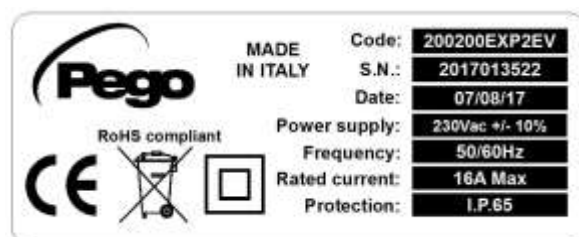

CHAPTER 2: INSTALLATION

GENERAL INSTALLATION RULES

2.1

1. Install the device in places where the protection rating is observed and try not to damage the box when drilling holes for wire/pipe seats.
2. Do not use multi-polar cables in which there are wires connected to inductive/power loads or signalling wires (e.g. probes/sensors and digital inputs).
3. Do not fit power supply wiring and signal wiring (probes/sensors and digital inputs) in the same raceways or ducts.
4. Minimise the length of connector wires so that wiring does not twist into a spiral shape as this could have negative effects on the electronics.
5. Install a general protection fuse upstream of the electronic control.
6. All wiring must be of a cross-section suitable for relevant power levels.
7. When it is necessary to make a probe/sensor extension, the wires must have a cross-section of at least 1mm². Probes extension or shortening could alter their factory calibration; therefore, to check and calibrate the probes through an external thermometer.
8. Tighten the 4 closing screws of the electrical panel with a torque not exceeding 1 newton meter

STANDARD EQUIPMENT FOR MOUNTING AND USE

2.2

The **ECP200 EXPERT 2EV** electronic controller is provided with the following for mounting and use:

- Nr 3 ring seals to be placed between the screw and the surface of the box;
- Nr 1 user manual;
- Nr 1 NTC 10K 1% black sensor, length = 1.5m
- Nr 2 NTC 10K 1% grey sensor, length = 3m

2.3

INSTALLATION OF THE BOARD

Fig. 1: Lift the transparent door that protects the differential magneto thermic circuit breaker and remove the cover for the screws on the right side.



Fig. 2: Remove the 4 fastening screws from the front panel of the box.



Fig. 3: Close the transparent door that protects the differential magneto thermal circuit breaker.



Fig.4: Open the front panel of the box by lifting it and sliding the two hinges until they reach the end stop.



Fig. 5: Press on the sides of each hinge to unlodge it and completely remove the front panel.



Fig. 6: Use the three pre-existing holes to fasten the base of the box with three adequately long screws based on the thickness of the wall that the panel will be installed on. Place a rubber washer (included) between each fastening screw and the base of the box.

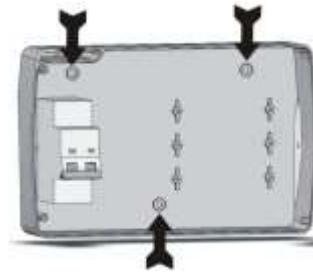
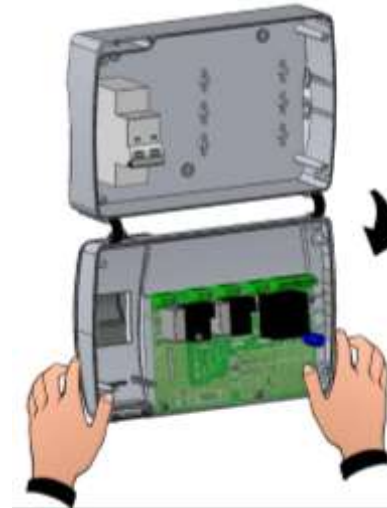

Fig. 7: Hook the front panel back on to the base of the box by re-inserting the hinges into their slots and making them bend. Rotate the panel downwards by 180° to access the circuit board.



Make all the electrical connections with reference to the annexed diagrams for the respective model (see the tables in the ANNEXES). To carry out the electrical connections reliably and maintain the degree of protection of the box, we recommend using suitable cable glands and / or pipe clamps to tightly seal all the wiring. It is advisable to distribute the cables within the panel as neatly as possible. In particular, keep the power cables away from the signal cables. Use any sealing strips.



Fig. 8: Close the front panel again, paying attention that the cables are inside the box and that the gasket for the box is correctly lodged into place. Fasten the front panel with the 4 screws with a torque not exceeding 1 newton meter. Power the panel and perform a thorough reading/programming of all the parameters.



Be sure not to tighten the closing screws excessively as this could cause the box to become deformed and jeopardise its correct functioning and tactile effect of the keyboard on the panel; do not exceed 1 newton meter of torque. Install protection devices against power surges for short-circuits, in order to avoid damage to the device on all of the loads connected to the electronic controller ECP202 EXPERT 2EV. Every time repair and/or maintenance is performed the panel must be disconnected from the power supply and from all possible inductive and power loads that it may be connected to; this is to guarantee the maximum safety conditions for the operator.



CHAPTER 3: TECHNICAL CHARACTERISTICS

3.1

TECHNICAL CHARACTERISTICS

Power supply			
Voltage	230 V~ ± 10% 50-60Hz		
Max power consumption (electronic control only)	~ 7 VA		
Max permitted consumption (with all loads connected)	16A		
Environmental conditions			
Working temperature	-5 to +50°C		
Storage temperature	-10 to +70°C		
Relative ambient humidity	Less than 90% Hr		
General characteristics			
Type of sensor connected	NTC 10K 1%		
Resolution	0.1 °C		
Precision of sensor readings	± 0.5 °C		
Reading range	-45 to +45 °C		
Output characteristics (voltage-free contacts)			
Description	Relay installed	Board output characteristics	Notes
Compressor	(30A AC1 Relay)	10A 250V~ (AC3) (2HP) (100000 cycles)	The sum of contemporary absorptions of these outputs <u>has not to exceed 16A</u> and the utilities power supply must derive from downstream of the thermal magnetic circuit breaker.
Defrost 1	(16A AC1 Relay)	16A 250V~ (AC1)	
Defrost 2	(16A AC1 Relay)	16A 250V~ (AC1)	
Fans	(16A AC1 Relay)	2.7A 250V~ (AC3)	
Room light	(16A AC1 Relay)	16A 250V~ (AC1)	
Alarm / Aux	(8A AC1 Relay)	8(3)A 250V~	
General electrical protection		16A differential thermal magnetic circuit breaker, Id=300mA 4.5 kA breaking capacity	
Dimensional characteristics			
Dimensions	18cm x 9.6cm x 26.3cm (HxWxL)		
Insulation and mechanical characteristics			
Degree of protection for the box	IP65		
Material of the box	ABS self-extinguishing		
Type of insulation	Class II		

WARRANTY TERMS

4.1

The **ECP200 EXPERT 2EV** electronic controls are covered by a 24-months warranty against all manufacturing defects as from the date indicated on the product ID code.

In case of defect the product must be appropriately packaged and sent to our production plant or to any authorized Service Center with the prior request of the Return Authorization Number.

Customers are entitled to have defective products repaired, spare parts and labor included. The costs and the risks of transport are at the total charge of the Customer. Any warranty action does not extend or renew its expiration.

The Warranty does not cover:

- Damages resulting from tampering, impact or improper installation of the product and its accessories.
- Installation, use or maintenance that does not comply with the instructions provided with the product.
- Repair work carried out by unauthorized personnel.
- Damage due to natural phenomena such as lightning, natural disasters, etc...

In all these cases the costs for repair will be charged to the customer.

The intervention service in warranty can be refused when the equipment is modified or transformed.

Under no circumstances **Pego S.r.l.** will be liable for any loss of data and information, costs of goods or substitute services, damage to property, people or animals, loss of sales or earnings, business interruption, any direct, indirect, incidental, consequential, damaging, punitive, special or consequential damages, in any way whatsoever caused, whether they are contractual, extra contractual or due to negligence or other liability arising from the use of the product or its installation.

Malfunction caused by tampering, bumps, inadequate installation automatically declines the warranty. It is compulsory to observe all the instructions in this manual and the operating conditions of the product.

Pego S.r.l. disclaims any liability for possible inaccuracies contained in this manual if due to errors in printing or transcription.

Pego S.r.l. reserves the right to make changes to its products which it deems necessary or useful without affecting its essential characteristics.

Each new release of the PEGO product user manual replaces all the previous ones.

As far as not expressly indicated, is applicable the Law and in particular the art. 1512 C.C. (Italian Civil Code).

For any controversy is elected and recognized by the parties the jurisdiction of the Court of Rovigo.

CHAPTER 5: DATA PROGRAMMING



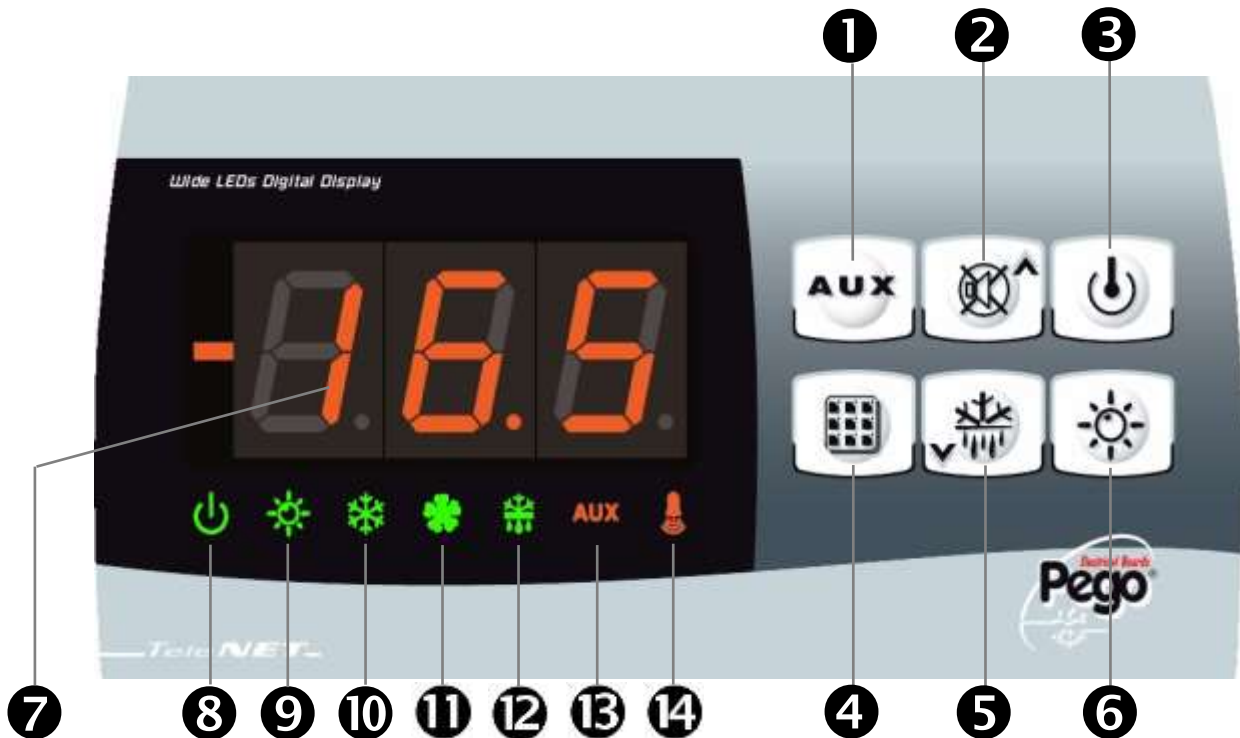

5.1



CONTROL PANEL



5.2







FRONT KEYPAD

- 1**  **AUXILIARY RELAY CONTROL**
The version with alarm relay allows you to control the relay manually if AU=1; press the button for 2.5 sec to display the current date/time.
- 2**  **UP / MUTE BUZZER ALARM**
Press for 2.5 seconds to open the HACCP menu.
- 3**  **STANDBY**
Press this to stop the system. The standby light flashes.
- 4**  **SET AMBIENT TEMPERATURE**
Press for 2.5 seconds together with the mute button, when on the HACCP menu, to reset the registered HACCP alarms.

- 5**  **DOWN / MANUAL DEFROST**
(press for 2.5 seconds to Start – Stop MANUAL DEFROST)
- 6**  **ROOM LIGHT**

LED DISPLAY

5.3

- 7** **AMBIENT TEMPERATURE VALUE / SETTINGS**
- 8**  **STANDBY ICON**
Led OFF = Board OFF
Led ON = Board ON and live
Led flashing = Board in stand-by (outputs are disabled)
- 9**  **DOOR SWITCH / ROOM LIGHT ICON**
Led OFF = Door switch disabled or not in use and room light OFF
Led ON = Room light ON
Led Flashing = Door switch enabled and room light ON
- 10**  **COLD CALL ICON**
Led OFF = Cold call OFF
Led ON = Cold call ON
Led Flashing = Cold call ON but awaiting pause time C1
- 11**  **FAN CALL ICON**
Led OFF = Fan call OFF
Led ON = Fan call ON
Led Flashing = Fans paused after defrost (see parameter F5)
- 12**  **DEFROST CALL ICON**
Led OFF = Defrost call OFF
Led ON = Defrost call ON
Led Flashing = Dripping phase in progress after defrost (see parameter D7)
- 13**  **AUXILIARY RELAY ICON** (with parameter AU=1)
Led OFF = Aux relay call OFF
Led ON = Aux relay call ON
- 14**  **ALARM ICON**
Led OFF = No alarm in progress
Led ON = Alarm activated then stopped (HACCP alarm registered)
Led Flashing = Alarm in progress

5.4

GENERAL



For reasons of safety and greater practicality for the operator, the **ECP200 EXPERT 2EV** has two programming levels; the first level (Level 1) is used to configure the frequently modified **SETPOINT** parameters. The second programming level (Level 2) is for general parameter programming of the various controller work modes.

It is not possible to access the Level 2 programming directly from Level 1: you must exit the programming mode first.

5.5

SYMBOLOLOGY

For purposes of practicality the following symbols are used:

- (▲) the UP key  is used to increase values and mute the alarm.
- (▼) the DOWN key  is used to decrease values and force defrosting.

5.6

SETTING AND DISPLAYING THE SET POINT

1. Press the **SET key** to display the current **SETPOINT** (temperature).
2. Hold down the **SET key** and press the (▲) or (▼) keys to modify the **SETPOINT**.
3. Release the **SET key** to return to cold room temperature display: the new setting will be saved automatically.

LEVEL 1 PROGRAMMING (User level)

5.7

To gain access to the Level 1 configuration menu proceed as follows:

1. Press the (▲) and (▼) keys simultaneously and keep them pressed for a few seconds until the first programming variable appears on the display.
2. Release the (▲) and (▼) keys.
3. Select the variable to be modified using the (▲) or (▼) key.
4. When the variable has been selected it is possible:
 - To display the setting by pressing SET key.
 - To modify the setting by pressing the SET key together with the (▲) or (▼) key.

When configuration values have been set you can exit the menu by pressing the (▲) and (▼) keys simultaneously for a few seconds until the cold room temperature reappears.

5. The new settings are saved automatically when you exit the configuration menu.

LIST OF LEVEL 1 VARIABLES (User level)

5.8

VARIABLES	MEANING	VALUES	DEFAULT
r0	Temperature differential in relation to the main SETPOINT.	0.2 - 10.0 °C	2°C
d0	Defrost interval (hours). In the case of two evaporators, the defrost process starts up at the same time for both (to delay the defrost process for evaporator 2, see variable dd2) and time d0 is loaded at the end of the previous defrost process. When d0=0 and dFr=0 Defrost disabled	0 - 24 hours	4 hours
dd2	Delayed defrost for the second evaporator (sec). The defrost process of the second evaporator starts up after the defrost process of the first evaporator. The delay between the two defrost processes is configured in dd2. Setting dd2 is to run the two defrost processes in succession. This avoids overloading the electrical system during the defrost process in the event of limited power. When dd2=0, defrost processes 1 and 2 start simultaneously.	0 - 10 sec 0 = defrost processes 1 and 2 start at the same time	0 sec
d21	Defrost end setpoint for evaporator 1. Defrost is not executed if the temperature detected by the defrost sensor is higher than the d21 value (defrost is timed if the sensor is broken).	-35 - 45 °C	15°C
d22	Defrost end setpoint for evaporator 2. Defrost is not executed if the temperature detected by the defrost sensor is higher than the d22 value (defrost is timed if the sensor is broken).	-35 - 45 °C	15°C
d31	Max defrost time for evaporator 1 (minutes)	1 - 240 min	25 min
d32	Max defrost time for evaporator 2 (minutes)	1 - 240 min	25 min
d7	Dripping time (minutes) At the end of the defrost process, the compressor and the fans stop for the d7 time configured and the defrost light on the front of the board flashes.	0 - 10 min	0 min

VARIABLES	MEANING	VALUES	DEFAULT
F5	Pause time for fans after defrost (minutes) To pause the fans for a period of time F5 after the dripping phase. This time counts down from the end of the dripping phase. If the dripping phase is not set, the fans are paused directly after the defrost process. The fan icon flashes during the pause time.	0 - 10 min	0 min
A1	Minimum temperature alarm Absolute temperature for the ambient sensor below which, after the Ald delay time, the EL low temperature alarm is activated and a record is made of this in the HACCP menu. When the EL alarm is activated, EL alternates with the temperature on the display, and the alarm relay, buzzer (which can be turned off), and alarm buzzer icon are all activated. The alarm turns off automatically when the conditions return to normal. The alarm light stays on to indicate the alarm has occurred and the event has been registered (see the HACCP menu to view and reset the temperature alarm concerned).	-45 - A2 °C	-45°C
A2	Maximum temperature alarm Absolute temperature for the ambient sensor above which, after the Ald delay time, the EH high temperature alarm is activated and a record is made of this in the HACCP menu. When the EH alarm is activated, EH alternates with the temperature on the display, and the alarm relay, buzzer (which can be turned off) and alarm buzzer icon are all activated. The alarm turns off automatically when the conditions return to normal. The alarm light stays on to indicate the alarm has occurred and the event has been registered (see the HACCP menu to view and reset the temperature alarm concerned).	A1 - +45 °C	+45°C
tE1	Shows the temperature detected by the sensor of evaporator 1	Shows the temperature of the evaporator (or remains blank, if dE1 =1)	Read-only
tE2	Shows the temperature detected by the sensor of evaporator 2	Shows the temperature of the evaporator (or remains blank, if dE2 =1)	Read-only
dFr	Enable evaporator defrost processes in real time When d0=0 and dFr=1, it is possible to configure up to 6 defrost processes in real time within a single day, using the parameters d41...d46	0 = disabled 1 = enabled	0
d41 ... d46	Program timers for evaporator defrost processes It is possible to configure up to 6 timers for the defrost processes. The defrost process, or processes in the case of 2 evaporators, depends on the configuration of the variables dd2, d21, d22, d31, d32. The timer is in the HH.MM format, where HH is the hour and M the minutes in sets of ten (e.g. 0=0 min, 1=10 min, etc.). The flashing full stop (.) indicates this is a timer and not a temperature.	00.0 - 23.5	--

LEVEL 2 PROGRAMMING (Installer level)

5.9

To access the second programming level, proceed as follows:

1. Press the UP (▲) and DOWN (▼) keys and the LIGHT key simultaneously for a few seconds. When the first programming variable appears the system automatically goes to stand-by.
2. Release the three keys.
3. Select the variable to be modified by pressing the UP (▲) and DOWN (▼) keys. When the parameter has been selected it is possible to:
 - View the setting by pressing the SET key.
 - Modify the setting by holding the SET key down and pressing the (▲) or (▼) key.
4. When configuration settings have been completed you can exit the menu by pressing the (▲) and (▼) keys simultaneously and keeping them pressed until the room temperature reappears.

Changes are saved automatically when you exit the configuration menu.

Press the STAND-BY key to enable electronic control.

LIST OF LEVEL 2 VARIABLES (Installer level)

5.10

VARIABLES	MEANING	VALUES	DEFAULT
nrE	Number of evaporators Configuring nrE=1 disables evaporator 2 and the defrost 2 output becomes a clean contact for calling the motor condensing unit (output parallel with compressor call). Output with clean contact.	1 = 1 evaporator 2 = 2 evaporators	2
AC	Status of the door switch input	0 = Normally open 1 = Normally closed	0
F3	Status of the fans with compressor OFF	0 = Fans run continuously 1 = Fans run only when compressor is ON	1
F4	Fan standby time during defrost	0 = The fans run during the defrost process 1 = The fans do not run during the defrost process	1
dE1	Presence of sensor for evaporator 1 When the evaporator sensor is disabled, the defrosting processes run cyclically for the time d0 or according to the real time clock, and end when the time d31 elapses.	0 = sensor of evaporator 1 present 1 = sensor of evaporator 1 absent	0
dE2	Presence of sensor for evaporator 2 When the evaporator sensor is disabled, the defrosting processes run cyclically for the time d0 or according to the real time clock, and end when the time d32 elapses.	0 = sensor of evaporator 2 present 1 = sensor of evaporator 2 absent	0
dC	Status of input for 'man in room' alarm	0 = NO 1 = NC	0
d1	Type of defrost , with cycle inversion (hot gas) or elements.	1 = hot gas 0 = elements	0
Ad	Network address for connection to the TeleNET supervision system	0 - 31	0

VARIABLES	MEANING	VALUES	DEFAULT
Ald	Delay time for signalling and displaying the minimum or maximum temperature alarm.	1...240 min	120 min
C1	Minimum time between the shutdown and next start-up of the compressor	0...15 min	0 min
CE1	Compressor run time in event of broken ambient sensor (emergency operation). With CE1=0, emergency operation in the event of the E0 error is disabled: the compressor remains switched off and the defrost processes are disabled to preserve the residual cold.	0...240 min 0= disabled	0 min
CE2	Compressor run time OFF in event of broken ambient sensor (emergency operation)	5...240 min	5 min
CAL	Correction of the ambient sensor reading	-10...+10	0
Pc	Status of compressor protection contact	0 = NO 1 = NC	0
doC	Run time of compressor for door switch: when the door switch opens the evaporator fans turn off and the compressor continues to run for the time doC before turning off.	0...5 minutes	0
tdo	Time for re-activating the compressor after opening of door: normal operation of the control is restored when the door switch opens and after the tdo time has elapsed, and the door open alarm is activated (Ed). With tdo=0, the parameter is disabled.	0...240 min 0 = disabled	0
Fst	FAN disabling TEMPERATURE The fans remain at standstill if the temperature detected by the evaporator sensor is higher than the value of this parameter.	-45...+45°C	+45°C
Fd	Differential for Fst	1...+10°C	2°C
tA	Switching of status for NO – NC alarm relay	0 = energizes in event of alarm 1 = de-energizes in event of alarm	1
LSE	Minimum value of the setpoint	-45 - HSE °C	-45°C
HSE	Maximum value of the setpoint	+45 - HSE °C	+45°C

VARIABLES	MEANING	VALUES	DEFAULT
AU	Management of the RL6 configurable relay	0 = alarm relay 1 = manual auxiliary relay commanded by the AUX button 2 = automatic auxiliary relay controlled by the StA temperature set with 2°C differential 3 = pump down function 4 = clean contact for calling the motor condensing unit (AUX relay parallel to the compressor) 5 = Contact for controlling the guard element (AUX relay closed with compressor output not enabled).	0
StA	Temperature set points for auxiliary relay	-45...+45°C	0
P1	Password: for protection (enabled when PA is set at a number other than 0)	0 = displays only the set point 1 = displays the set point, access to the light and AUX buttons 2 = prevents access to programming 3 = prevents access to level two programming	3
PA	Password (see P1 for type of protection)	0...999 0 = function disabled	0
Yr	Year configuration	0...99	-
Mo	Month configuration	1...12	-
dy	Day configuration	1...31	-
Hr	Hour configuration	0...23	-
min	Minute configuration	0...59	-
reL	Software release	indicates the software version	Read-only

5.11

HACCP ALARM MANAGEMENT

The EL low temperature alarm is activated at the end of the Ald time when the ambient sensor temperature is $\leq A1$.

The EH high temperature alarm is activated at the end of the Ald time when the ambient sensor temperature is $\geq A2$.

During a high or low temperature alarm, the temperature alternates with EH or EL on the display; and the alarm relay, buzzer (which can be silenced) and alarm buzzer icon (flashing) are activated. The alarm signals stop automatically when normal operation is restored (the alarm relay is deactivated, the buzzer stops and the display returns to normal). The alarm buzzer icon, however, remains on (steady) to indicate the EH or EL alarm has been activated and that the event has been registered (see the HACCP menu to view and reset the temperature alarm that has occurred).

An alarm log states the date the last EH or EL event occurred, its duration and the maximum or minimum temperature reached.

There is also a counter that indicates the number of alarms to have occurred since the last alarm reset. To view a temperature alarm, access the HACCP menu (press the mute button for 2.5 seconds). It is possible to reset the alarm registered in the menu by pressing and holding the mute and SET buttons for 2.5 seconds. The buzzer beeps to confirm the alarm is cancelled. To exit the menu, wait for 10 seconds without touching any of the buttons, or press the up and down arrow buttons at the same time.

The variables in the HACCP menu are read-only and are as follows:

VARIABLES	MEANING	VALUES	DEFAULT
E##	Indicates the last temperature alarm to have occurred	EH = high temperature alarm EL = low temperature alarm -- = no alarm occurred since last reset	Read only
###	Peak temperature value reached during last EH or EL alarm	-45...+45°C --- = no alarm occurred since last reset	Read only
y##	Year the last temperature alarm started	y00 – y99 y-- = no alarm occurred since last reset	Read only
M##	Month the last temperature alarm started	M01 – M12 M-- = no alarm occurred since last reset	Read only
d##	Day the last temperature alarm started	d01 – d31 d-- = no alarm occurred since last reset	Read only
h##	Hour the last temperature alarm started	h00 – h24 h-- = no alarm occurred since last reset	Read only
m##	Minutes the last temperature alarm started	m00 – m59 m-- = no alarm occurred since last reset	Read only
t##	Time (hours) the last temperature alarm lasted	t00 – t99 t-- = no alarm occurred since last reset	Read only
C##	Counter indicating the number of temperature alarm events occurred (when the data is registered for an alarm event, the reading on the counter increases by one and the counter indicates whether other alarms occurred previously. The counter is reset at the same time as resetting the registered alarm (press the mute and SET button x 5sec.) The counter increases by one whenever a new temperature alarm occurs).	C00 – C99 C-- = no alarm occurred since last reset	Read only

SWITCHING ON THE ECP200 EXPERT 2EV ELECTRONIC CONTROLLER

5.12

After wiring the electronic controller correctly, power up at 230 V AC; the display panel will immediately emit a beep and all the LEDs will come on simultaneously for a few seconds.

CONFIGURATIONS

5.13

- Use of 1 evaporator
- Use of 2 evaporators

Configure the nrE (number of evaporators) parameter to select one of these options.

When nrE=1, the sensor of evaporator 2 is disabled, variables d22 and d32 are ignored, variable tE2 is displayed as ---, and the defrost 2 output becomes a clean contact for calling the motor condensing unit (output parallel with compressor call).

In the event of defrosting with 2 evaporators, normal thermostating does not occur until the defrosting processes for both evaporators have ended.

COMPRESSOR ACTIVATION/DEACTIVATION CONDITIONS

5.14

The **ECP200 EXPERT 2EV** controller activates the compressor command when the ambient temperature exceeds the sum of the configured set point and the differential (r0); and deactivates the compressor when the ambient temperature is less than the configured set point.

If you decide to select the Pump-Down function (parameter AU=4), refer to chapter 5.15 on the conditions for activating/deactivating the compressor.

MANUAL DEFROSTING ACTIVATION

5.15

To start the defrosting process, simply press the  button for a few seconds; this activates the relay of the elements when the conditions are right.

The defrosting process of each of the two evaporators ends when the temperature of the associated defrost end variable (d21 or d22) is reached, or when the maximum defrost time (d31 or d32) elapses. The delay between the processes (variable dd2) is also factored in.

A defrosting output is not activated when the temperature of the respective defrost end variable (d21 or d22) is found to be less than the temperature detected by the sensor of the evaporator concerned.

Manual defrosting is also possible when the defrosting processes are configured using the real time clock.

5.16**STOPPING THE DEFROSTING PROCESS MANUALLY**

Pressing the  key for 2.5 seconds when defrosting is in progress stops both defrosting processes.

5.17**HOT GAS DEFROSTING**

Set parameter d1 = 1 to select defrosting with cycle inversion.

The compressor relay and defrost relays are activated during the entire defrosting phase. To run the plant correctly, the installer must ensure the defrost output opens the cycle inversion solenoid valve and closes the liquid solenoid valve.

For capillary plants (without thermostatic valve), simply use the cycle inversion solenoid valve with the defrost relay command.

5.18**PUMP DOWN FUNCTION**

Setting parameter AU=3 enables shutdown of the compressor in pump down mode.

The digital “main in room” alarm input becomes a work pressure gauge input and controls the compressor output directly. The AUX relay (clean contact on connectors 21–22) becomes the evaporator solenoid call and is controlled by the thermostat’s cold call.

PASSWORD FUNCTION

5.19

When parameter PA is setting with value different to 0 the protection function is activated.

See parameter P1 for the different protection.

When PA is setting the protection start after two minutes of inactivity. On display appear 000. With up/down modify the number, with set key confirm it.

Use universal number 100 if you don't remember the password.

(P.S. the password window closes to return to normal view if the keypad is not used for 30 seconds).

EMERGENCY OPERATION IN THE EVENT OF BROKEN
AMBIENT SENSOR (E0)

5.20

This safety mode allows the compressor to continue running even when the ambient sensor is broken (E0 error).

When there is the E0 sensor error and CE1 is set at a number other than 0, the compressor works in work pause mode, turning ON for the CE1 time and OFF for the CE2 time.

When $CE1 > 0$ and there is the E0 error, the defrost processes run in normal work mode.

When $CE1 = 0$ and there is the E0 error, emergency operation is disabled: the compressor remains off and the defrost processes are disabled to preserve any residual cold.

Eliminate the cause of the E0 error as soon as possible and re-enable normal operation of the controller for correct temperature control.

CURRENT DATE AND TIME

5.21

When you are not programming, press the AUX button for 2.5 seconds to display the current date and time. Each of the following variables is displayed for 2 seconds in succession:

y##: (year)
M##: (month)
d##: (day)
h##: (hour)
m##: (minutes)

The temperature is displayed again at the end.

CHAPTER 6: OPTIONS

6.1

TELENET MONITORING/SUPERVISION SYSTEM

Connect the ECP200 EXPERT 2EV to the TeleNET monitoring and supervision system as follows:

1. Assign a single network address with the 2nd level Ad. variable.
2. The TeleNET connectors on the board are 10=RS-485(A) and 11=RS-485(B); respect identification (A) and (B) of the RS-485 line and do not execute star connections. Refer to the connection example shown below.
3. In the TeleNET program, when creating the new instrument, set the "Module" as "Instrument ECP 200 2EV".

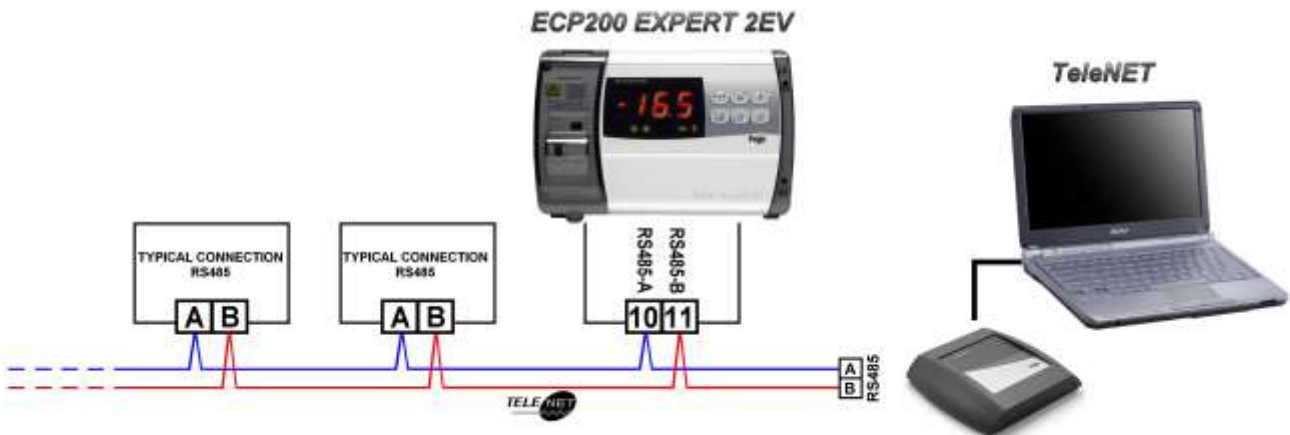

CHAPTER 7: DIAGNOSTICS

DIAGNOSTICS

7.1

The **ECP200 EXPERT 2EV** controller warns the operator of any errors by displaying alarm codes and sounding the internal buzzer. In the event of an alarm, the  icon appears on the display, the alarm relay is activated (if configured with AU=0), the internal buzzer is activated and one of the following alarm codes appears. You can press the “Mute” button at any time to stop the internal buzzer and remove the alarm code from the display. Pressing the SET button afterwards re-activates the acoustic warning and puts the codes back up on the display (the buzzer cannot be muted in the event of serious alarms).

ALARM CODE	POSSIBLE CAUSE	SOLUTION
E0	Functional fault of the ambient sensor	<ul style="list-style-type: none"> • Check the condition of the ambient sensor. • Replace the sensor if the problem persists.
E1	Functional fault of defrost sensor 1 (in this case any defrost processes last for the time set in parameter d31)	<ul style="list-style-type: none"> • Check the condition of defrost sensor 1. • Replace the sensor if the problem persists.
E2	Functional fault of defrost sensor 2 (in this case any defrost processes last for the time set in parameter d32)	<ul style="list-style-type: none"> • Check the condition of defrost sensor 2. • Replace the sensor if the problem persists.
E3	Eeprom alarm An error has occurred in the EEPROM memory. (All the outputs are disabled with the exception of the alarm ones)	<ul style="list-style-type: none"> • Turn the appliance off and then on again
E6	Battery low alarm ; the controller will continue to work for at least another 20 days, and when the battery is completely dead the time settings are cancelled.	<ul style="list-style-type: none"> • Replace the battery
E8	“Man in room” alarm The “man in room” button has been pressed to warn of a dangerous situation	<ul style="list-style-type: none"> • Reset the button in the room
Ec	Activation of the compressor’s protective devices (e.g. thermal protection or max pressure gauge). (All the outputs are disabled with the exception of the alarm ones, if available)	<ul style="list-style-type: none"> • Check the condition of the compressor • Check the consumption of the compressor • Contact the technical assistance service if the problem persists
Ed	Door open alarm The door has been open for longer than the configured tdo time.	<ul style="list-style-type: none"> • Close the door. • Check the condition of the door switch and its connections.
EL	Minimum temperature alarm EL flashes on the display in alternation with the temperature (see parameter A1)	
EH	Maximum temperature alarm EH flashes on the display in alternation with the temperature (see parameter A2)	

ANNEXES

A.1

EU DECLARATION OF CONFORMITY

LA PRESENTE DICHIARAZIONE DI CONFORMITA' E' RILASCIATA SOTTO LA RESPONSABILITA' ESCLUSIVA DEL FABBRICANTE:
THIS DECLARATION OF CONFORMITY IS ISSUED UNDER THE EXCLUSIVE RESPONSIBILITY OF THE MANUFACTURER:



PEGO S.r.l. a socio unico - Via Piacentina 6/b, 45030 Occhiobello (RO) – Italy –
 Società soggetta all'attività di direzione e coordinamento di Castel S.r.l.

DENOMINAZIONE DEL PRODOTTO IN OGGETTO / DENOMINATION OF THE PRODUCT IN OBJECT

MOD.: **ECP200 EXPERT 2EV**

IL PRODOTTO DI CUI SOPRA E' CONFORME ALLA PERTINENTE NORMATIVA DI ARMONIZZAZIONE DELL'UNIONE EUROPEA:
THE PRODUCT IS IN CONFORMITY WITH THE RELEVANT EUROPEAN HARMONIZATION LEGISLATION:

Direttiva Bassa Tensione (LVD):	2014/35/UE
<i>Low voltage directive (LVD):</i>	2014/35/EU
Direttiva EMC:	2014/30/UE
<i>Electromagnetic compatibility (EMC):</i>	2014/30/EU

LA CONFORMITA' PRESCRITTA DALLA DIRETTIVA E' GARANTITA DALL'ADEMPIMENTO A TUTTI GLI EFFETTI DELLE SEGUENTI NORME:
THE CONFORMITY REQUIRED BY THE DIRECTIVE IS GUARANTEED BY THE FULFILLMENT TO THE FOLLOWING STANDARDS:

Norme armonizzate: **EN 60730-1:2016, EN 60730-2-9:2010, EN 61000-6-1:2007, EN 61000-6-3:2007**
 European standards: **EN 60730-1:2016, EN 60730-2-9:2010, EN 61000-6-1:2007, EN 61000-6-3:2007**

IL PRODOTTO E' COSTITUITO PER ESSERE INCORPORATO IN UNA MACCHINA O PER ESSERE ASSEMBLATO CON ALTRI MACCHINARI PER COSTITUIRE UNA MACCHINA CONSIDERATE DALLA DIRETTIVA: 2006/42/CE "Direttiva Macchine".
THE PRODUCT HAS BEEN MANUFACTURED TO BE INCLUDED IN A MACHINE OR TO BE ASSEMBLED TOGETHER WITH OTHER MACHINERY TO COMPLETE A MACHINE ACCORDING TO DIRECTIVE: EC/2006/42 "Machinery Directive".

Firmato per nome e per conto di:
Signed for and on behalf of:

Pego S.r.l.
Martino Villa
Presidente

Luogo e Data del rilascio:
Place and Date of Release:

Occhiobello (RO), 01/01/2020

ECP200 EXPERT 2EV CONNECTION DIAGRAM

A.2

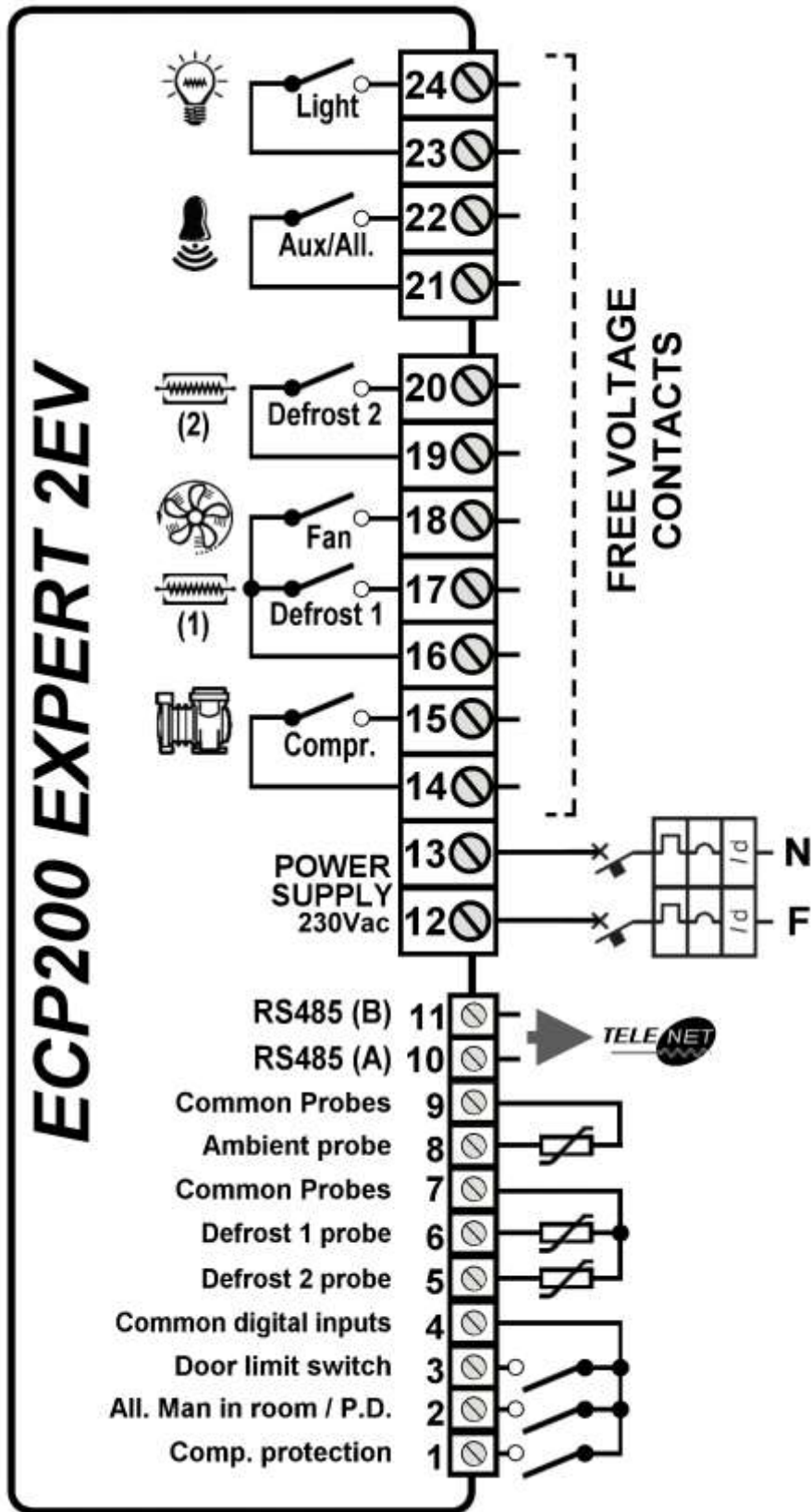

A.3

EXPLODED DIAGRAM

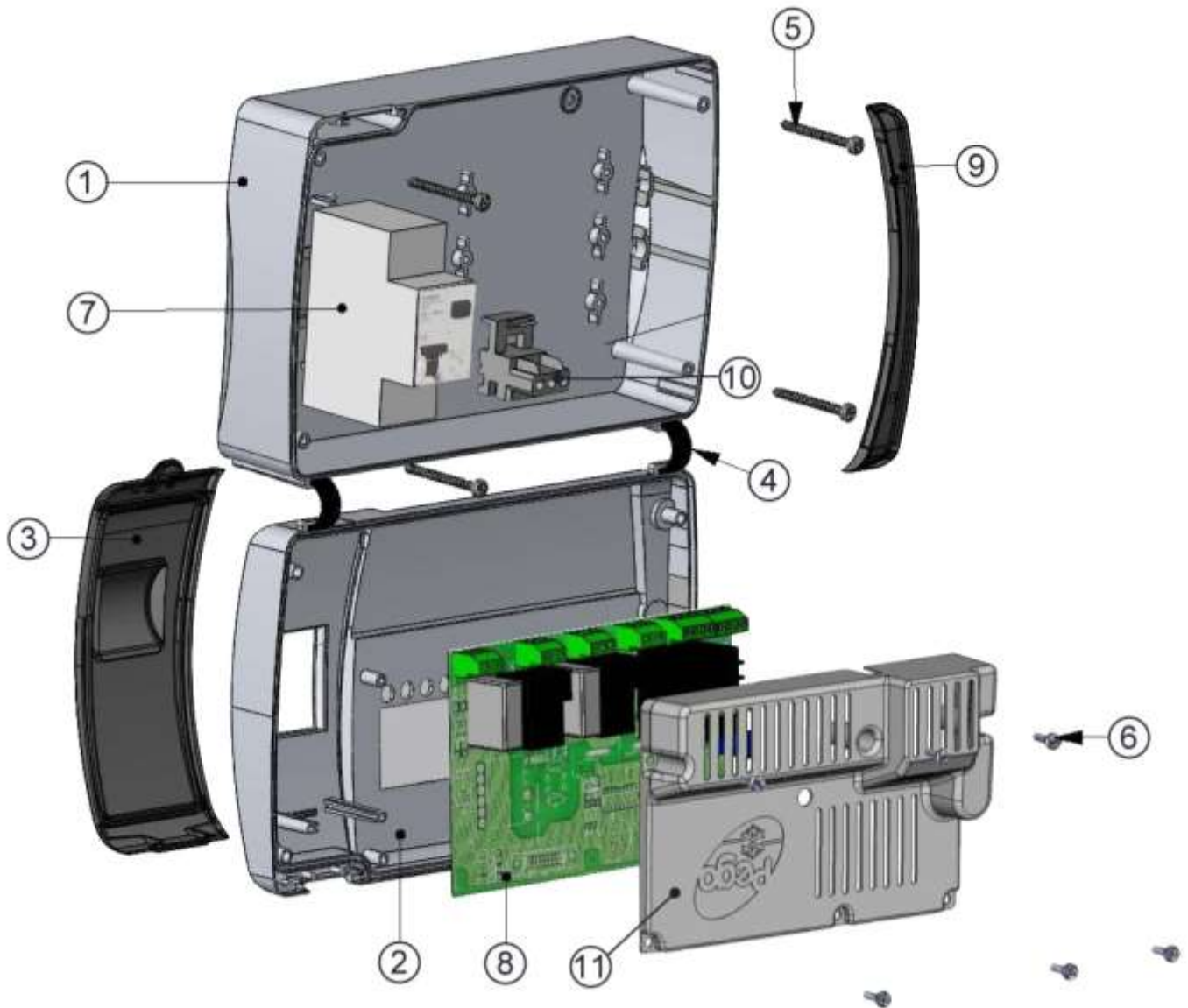

LEGEND

REF.	DESCRIPTION
1	BACK BOX IN ABS
2	FRONT BOX IN ABS
3	TRANSPARENT POLYCARBONATE COVER AT FRONT
4	HINGES FOR OPENING THE FRONT BOX
5	SCREWS FOR BOX
6	SCREWS FOR CONNECTION TO THE BOARD
7	DIFFERENTIAL THERMAL MAGNETIC PROTECTION / CIRCUIT BREAKER
8	CPU BOARD
9	POLYCARBONATE COVER FOR THE SCREWS
10	EARTH CONNECTOR
11	PROTECTIVE COVER FOR BOARD



PEGO s.r.l.
Via Piacentina, 6/b 45030 Occhiobello ROVIGO - ITALY
Tel. +39 0425 762906
e-mail: info@pego.it – www.pego.it

AFTER-SALES ASSISTANCE SERVICE
Tel. +39 0425 762906 e-mail: tecnico@pego.it

Distributor: