

VISION100 THR



Use and maintenance manual

ENGLISH

READ AND KEEP

TABLE OF CONTENTS

INTRODUCTION

CHAP. 1

Page 4	1.1	Generality
Page 5	1.2	Product identification codes
Page 5	1.3	Overall clearances
Page 5	1.4	Identification data

INSTALLATION

CHAP. 2

Page 6	2.1	Main warnings for the installer
Page 6	2.2	Standard equipment for assembly and use
Page 7	2.3	Board installation
Page 8	2.4	Functions managed by VISION100 THR

TECHNICAL FEATURES

CHAP. 3

Page 9	3.1	Technical features
--------	-----	--------------------

WARRANTY TERMS

CHAP. 4

Page 10	4.1	Warranty terms
---------	-----	----------------

DATA PROGRAMMING

CHAP. 5

Page 11	5.1	Control panel
Page 11	5.2	Front keyboard
Page 12	5.3	LED Display
Page 14	5.4	Generality
Page 14	5.5	Symbols
Page 14	5.6	Setpoint setting and displaying
Page 15	5.7	First level programming
Page 15	5.8	First level variables list
Page 17	5.9	Second level programming
Page 17	5.10	Second level variables list
Page 20	5.11	Automatic programmes Pr1, Pr2, Pr3, Pr4, Pr5
Page 22	5.12	Germination day/night cycle
Page 23	5.13	Electronic controller VISION100 THR ignition
Page 23	5.14	Cold/hot: ambient temperature maintenance
Page 24	5.15	Humidity/dehumidification: ambient humidity maintenance
Page 25	5.16	Ventilation
Page 25	5.17	Air change
Page 26	5.18	Refreshment or pause
Page 26	5.19	Defrosting
Page 26	5.20	Defrosting with hot gas
Page 27	5.21	Password function
Page 27	5.22	Automatic programmes
Page 29	5.23	Day/night cycle for germination lights

OPTIONS

CHAP. 6

Page 30	6.1	Supervision/monitoring system TeleNET
---------	-----	---------------------------------------

DIAGNOSTIC

CHAP. 7

Page 31	7.1	Diagnostic
---------	-----	------------

ATTACHMENTS

Page 32	A.1	EU Declaration of Conformity
Page 33	A.2	VISION100 THR Connection layout

CHAPTER 1: INTRODUCTION

1.1

GENERALITY

DESCRIPTION:

The **VISION100 THR** control enables managing temperature and humidity in seasoning, preservation and industrial processes ambients.

The system is composed of the 100N MASTER THR unit on which all electric connections are carried out and of the VISION100 THR control console equipped with LCD display for quick and complete information on the cell state. In its whole, it enables controlling cold, hot, ventilation, cell light, humidification, air change, refreshments, dehumidification, defrosting, alarms. Up to five settable and customisable programmes, each of seven phases.

APPLICATIONS:

- Seasoning and drying cells.
- Germination cells with day/night phases.
- Preservation cells with or without humidity control.

MAIN FEATURES:

- Back-lit LCD display.
- 7 state LED.
- Clock and calendar.
- Manual or automatic functioning.
- Up to a maximum of 5 completely customisable programmes. Automatic management of 7 phases for each program. Simple programming and selection of set programmes. More programmes can be combined to exceed the limit of 7 phases.
- Possibility of excluding hot and humidity to manage only preservation cell with defrosting activation.
- Temperature with decimal point.
- Password for keys lock.
- Day/night cycle for germination plants with double setpoint.
- Dehumidification programming with cold or hot request.

PRODUCT IDENTIFICATION CODES

1.2

200VIS100THR

Temperature and humidity control for seasoning, preservation and industrial processes. Complete with VISION THR and 100N MASTER THR display.

OVERALL CLEARANCES

1.3

Dimensions in mm:

VISION THR



100N MASTER THR

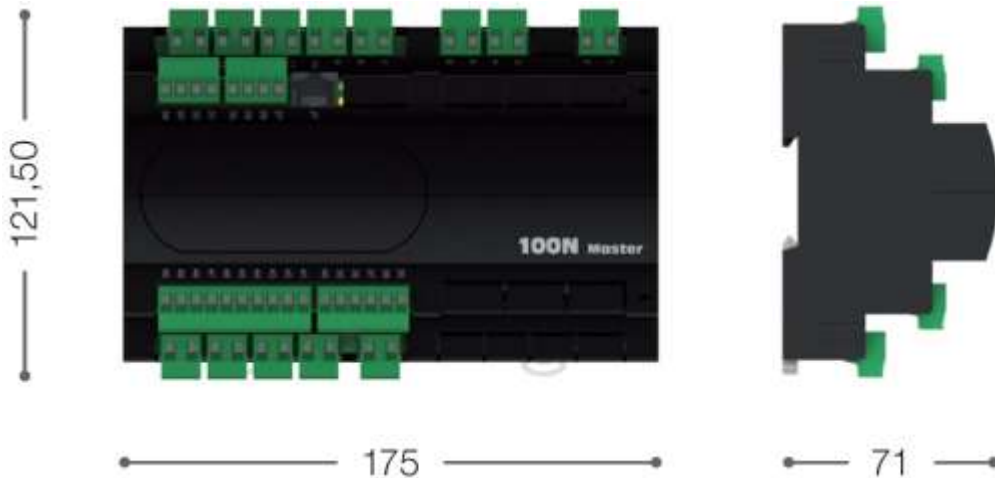

IDENTIFICATION DATA

1.4

The equipment described in this manual is provided with an identification data plate of the same placed on one side:

- Name of Manufacturer
- Equipment code
- Serial number
- Date of production
- Power supply voltage

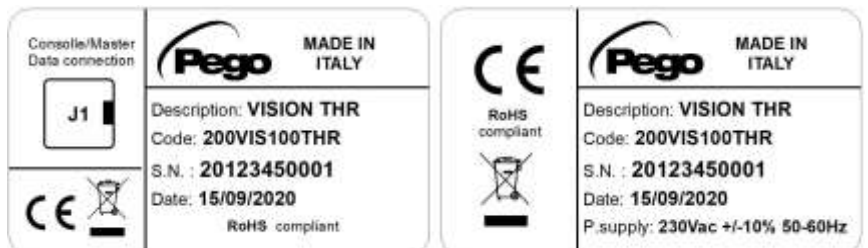

CHAPTER 2: INSTALLATION

2.1

MAIN WARNINGS FOR THE INSTALLER

1. Install the device in places where the protection rating is observed and try not to damage the box when drilling holes for wire/pipe seats;
2. Do not use multi-polar cables in which there are wires connected to inductive/power loads or signaling wires (e.g. probes and digital inputs);
3. Do not fit power supply wiring and signal wiring (probes and digital inputs) in the same raceways or ducts;
4. Minimize the length of connector wires so that the wiring does not have a spiral shape;
5. All wiring must be of a cross-section suitable for relevant power levels;
6. Place a general protection fuse upstream from the electronic controller;
7. When it is necessary to extend the probes, the wires must have a cross-section of at least 1mm². The probes extension or shortening could alter the factory calibration; then check and calibrate through an external thermometer.

2.2

STANDARD EQUIPMENT FOR ASSEMBLY AND USE

For assembly and use, the electronic controller **VISION 100 THR**, is equipped with:

- N. 2 temperature probes;
- N. 1 telephone plug cable;
- N. 1 user manual;
- N. 1 Vision console (200VISIONTHR);
- N. 1 100N MASTER (200100NMSTH1);

INSTALLATION

2.3

Fig. 1: Position the module 100N MASTER on the DIN guide and close the 2 lower hooks to lock it on the same.

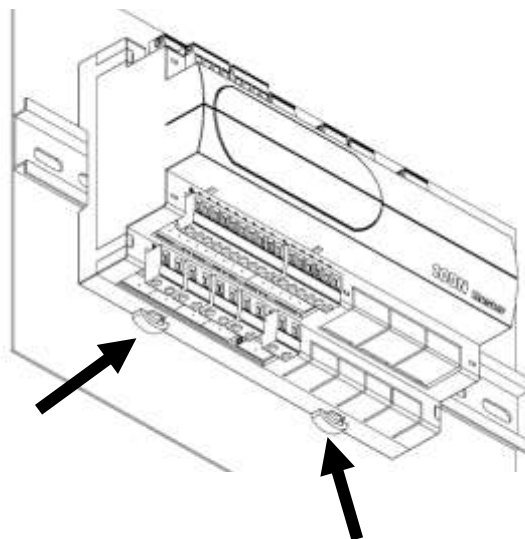

Fig. 2: Fix the VISION THR console using the two screws to be inserted in the slots underneath the keys frame.

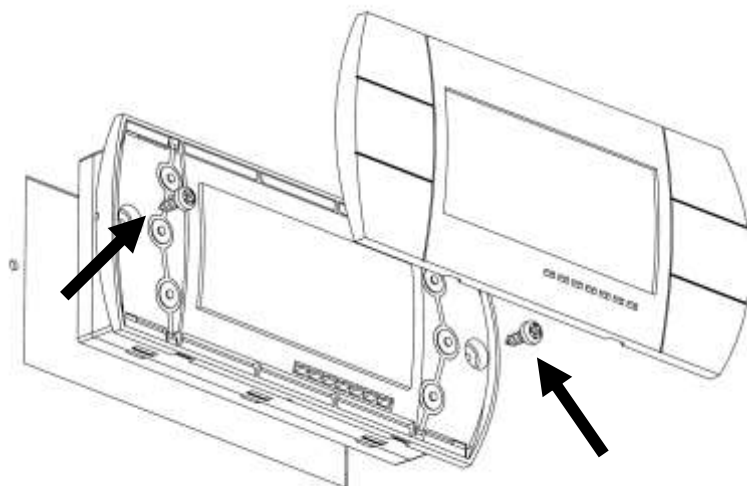
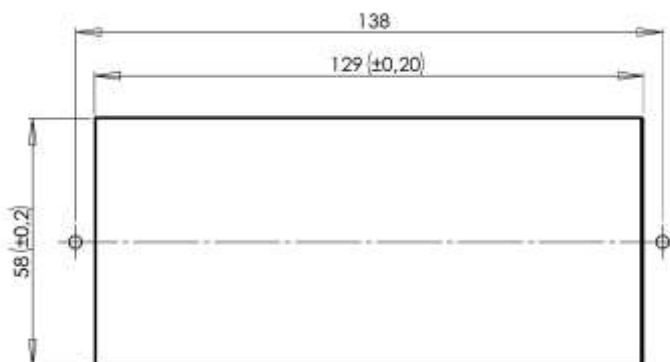

Fig. 3: VISION THR console perforation template.



FUNCTIONS MANAGED BY VISION 100 THR

2.4

- Temperature set and humidity set (neutral area) parameters adjustment and displaying.
- Stand-by state activation/deactivation.
- Probes alarms signal.
- Air change control parameters adjustment.
- Defrosting parameters adjustment.
- Refreshments parameters adjustment.
- Fans parameters adjustment.
- Outputs state displaying.
- Simultaneous displaying of humidity and temperature value.
- Automatic programmes management with automatic variation of temperature and humidity set in time.
- Clock function.

CHAPTER 3: TECHNICAL FEATURES

TECHNICAL FEATURES

Power supply			
Voltage	230 V~ ± 10% 50/60Hz		
Max. absorbed power (electronic control only)	~ 8 VA		
Climatic Conditions			
Work temperature	-5 ÷ +50 °C		
Storage temperature	-10 ÷ +70 °C		
Ambient relative humidity	Below 90% Hr		
Main Features			
Type of connectable probes (temperature)	NTC 10K 1%		
Resolution (ambient temperature)	0.1°C		
Probes reading precision (ambient temperature)	± 0.5°C		
Reading range	-45 ÷ +45 °C		
Humidity probe	analogical input 4-20 mA		
Humidity probe reading precision	see humidity probe features		
Humidity probe reading range	0-99 Hr%		
Output features			
Description	Installed relay	Board output features	Notes
Cold (output 3-4)	(Relay 30A AC1)	10A 250V~ (AC3) (2HP) (100000 cycles)	All outputs are contacts without voltage
9 outputs from 5 to 21 (see connections layout)	(Relay 16A AC1)	16A 250V~ (AC1)	
Dimensional features			
100N MASTER Dimensions	121.50mm x 71mm x 175mm (HxDxL)		
VISION100 THR Dimensions (fitted)	70mm x 32mm x 158mm (HxDxL)		
Mechanical and insulation features			
Display protection degree	IP65		
Box material	Self-extinguishing ABS		

4.1

WARRANTY TERMS

The **VISION100 THR** series electronic controls are covered by a 24-months warranty against all manufacturing defects as from the date indicated on the product ID code.

In case of defect the product must be appropriately packaged and sent to our production plant or to any authorized Service Center with the prior request of the Return Authorization Number.

Customers are entitled to have defective products repaired, spare parts and labor included. The costs and the risks of transport are at the total charge of the Customer. Any warranty action does not extend or renew its expiration.

The Warranty does not cover:

- Damages resulting from tampering, impact or improper installation of the product and its accessories.
- Installation, use or maintenance that does not comply with the instructions provided with the product.
- Repair work carried out by unauthorized personnel.
- Damage due to natural phenomena such as lightning, natural disasters, etc...

In all these cases the costs for repair will be charged to the customer.

The intervention service in warranty can be refused when the equipment is modified or transformed.

Under no circumstances **Pego S.r.l.** will be liable for any loss of data and information, costs of goods or substitute services, damage to property, people or animals, loss of sales or earnings, business interruption, any direct, indirect, incidental, consequential, damaging, punitive, special or consequential damages, in any way whatsoever caused, whether they are contractual, extra contractual or due to negligence or other liability arising from the use of the product or its installation.

Malfunction caused by tampering, bumps, inadequate installation automatically declines the warranty. It is compulsory to observe all the instructions in this manual and the operating conditions of the product.

Pego S.r.l. disclaims any liability for possible inaccuracies contained in this manual if due to errors in printing or transcription.

Pego S.r.l. reserves the right to make changes to its products which it deems necessary or useful without affecting its essential characteristics.

Each new release of the Pego product user manual replaces all the previous ones.

As far as not expressly indicated, is applicable the Law and in particular the art. 1512 C.C. (Italian Civil Code).

For any controversy is elected and recognized by the parties the jurisdiction of the Court of Rovigo.

CHAPTER 5: DATA PROGRAMMING





CONTROL PANEL

5.1



FRONT KEYBOARD

5.2

- 1**  **PROGRAM START/STOP** (press for 5 seconds to select the program to be performed, press for 5 seconds to end a program in progress)
TIMER (by pressing the key once it displays remaining time of phase in execution)
- 2**  **UP**
MANUAL REFRESHMENT and DEFROSTING (activates both functions)
- 3**  **STAND BY** (plant ON/OFF, the program in progress keeps the remaining time count)
- 4**  **SET** ambient and humidity temperature (subsequent pressing alternate temperature and humidity)

5  DOWN / MUTE ALARM / AIR CHANGE FORCING

6  CELL LIGHT

5.3

LED DISPLAY

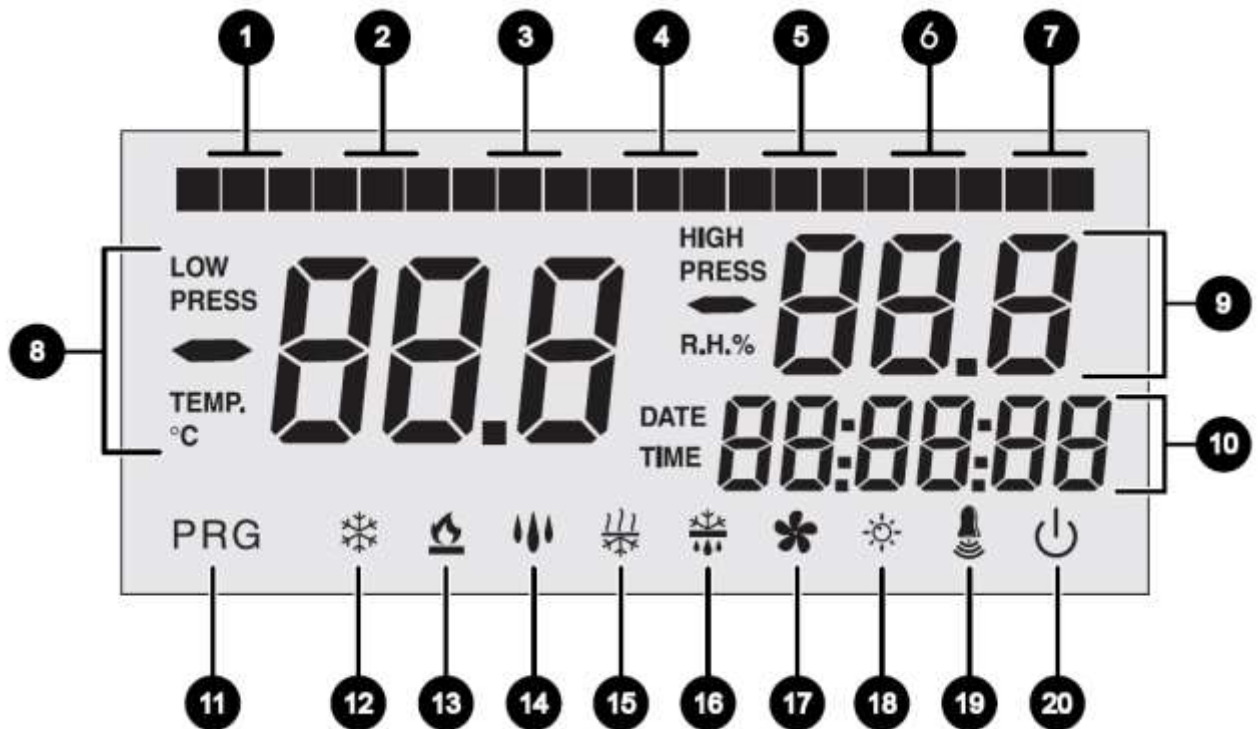













1  PHASE 0 Advance/Dripping/Germination day phase

2  PHASE 1 advancement

3  PHASE 2 advancement

4  PHASE 3 advancement

- 5 4  PHASE 4 advancement / Night PHASE germination
- 6 5  PHASE 5 advancement
- 7 R  Refreshment
- 8  Parameters/ambient temperature value
- 9  Ambient relative humidity value/parameters value/error codes
- 10  Time/date/time parameters values/program in progress/timer
- 11 **PRG** Programming (control is in programming phase)
- 12  Cold (flashing if only called for dehumidification)
- 13  Hot (flashing if only called for dehumidification)
- 14  Humidification
- 15  Dehumidification
- 16  Defrosting
- 17  Fans

18



Light (flashing if door switch is active)

19



Alarm

20



Stand-by

5.4



GENERALITY

For operator safety and practicality, the **VISION100 THR system** envisions two programming levels; the first for configuration of the, frequently amendable, **SETPOINT** parameters only, the second for programming and setting of the main parameters relating to the various board functioning modes. It is not possible to directly access the second level from first level programming, exit current programming first.

5.5

SYMBOLS

For practicality we will use the following symbols:

- (▲) the UP key  that performs value increase functions and forcing of defrosting/refreshing;
- (▼) the DOWN key  that performs value decrease, mute alarm and air change forcing functions.

5.6

SETPOINT SETTING AND DISPLAYING

1. Press the **SET key** to display the current **SETPOINT** value (alternatively, temperature and humidity).
2. Keeping the **SET key** pressed and pressing one of the (▲) or (▼) keys, the **SETPOINT** value can be amended.

Release the **SET key** to return to displaying the cell temperature; memorising of the made amendments will automatically happen.

FIRST LEVEL PROGRAMMING (User level)

5.7

To access the first level configuration:

1. Keep the keys (\blacktriangle) and (\blacktriangledown) pressed simultaneously for a few seconds until the first programming variable appears on the display.
2. Release the keys (\blacktriangle) and (\blacktriangledown).
3. Using the (\blacktriangle) key or (\blacktriangledown) key, select the variable to be amended.
4. After having selected the wanted variable, it will be possible:
 - To display its setting by pressing the SET key.
 - Amend its setting by keeping the SET key pressed and by pressing one of the (\blacktriangle) or (\blacktriangledown) keys. To exit the menu once the configuration values are set, simultaneously keep the (\blacktriangle) and (\blacktriangledown) keys pressed for a few seconds, until the cell temperature value appears again.
5. Memorisation of the amendments made to the variables will happen automatically when exiting the configuration menu.

FIRST LEVEL VARIABLES LIST (User Level)

5.8

VARIABLES	MEANING	VALUES	DEFAULT
dtC	HOT temperature differential referred to main SETPOINT. It is expressed in absolute value and defines the temperature hysteresis for HOT referred to temperature SETPOINT.	$(dtn+0.2) \div 10 \text{ }^\circ\text{C}$	2,0 $^\circ\text{C}$
dtF	COLD temperature differential referred to main SETPOINT. It is expressed in absolute value and defines the temperature hysteresis for COLD referred to temperature SETPOINT.	$(dtn+0.2) \div 10 \text{ }^\circ\text{C}$	2,0 $^\circ\text{C}$
dtn	NEUTRAL temperature area referred to main SETPOINT. Cold and hot are not activated in neutral area; it symmetrically includes an upper part (hot) and a lower part (cold) respect to temperature SETPOINT.	$dtF > dtn \div 0 \text{ }^\circ\text{C}$ $dtC > dtn \div 0 \text{ }^\circ\text{C}$	0,0 $^\circ\text{C}$
dUU	HUMIDIFICATION differential referred to main SETPOINT. It is expressed in absolute value and defines the humidification hysteresis referred to humidity SETPOINT.	$(dUn+1) \div 10 \text{ rH\%}$	5 rH%
dUd	DEHUMIDIFICATION differential referred to humidity SETPOINT. It is expressed in absolute value and defines the dehumidification hysteresis referred to humidity SETPOINT.	$(dUn+1) \div 10 \text{ rH\%}$	5 rH%
dUn	NEUTRAL humidity area referred to main SETPOINT. Humidification and dehumidification are not activated in neutral area; it symmetrically includes an upper part (humidification) and a lower part (dehumidification) respect to humidity SETPOINT.	$dUU > dUn \div 0 \text{ rH\%}$ $dUd > dUn \div 0 \text{ rH\%}$	0 rH%
d4	Defrosting interval (hours). d4=0 disables defrosting	0 \div 24 hours	0 hours
d5	Defrosting maximum duration (minutes)	1 \div 60 min	10 min
d6	End defrosting setpoint. Defrosting is not carried out if the temperature read by the defrosting probe is higher than value d6. (In case of faulty probe, timed defrosting is carried out)	-35 \div 45 $^\circ\text{C}$	15 $^\circ\text{C}$
d7	Dripping duration (minutes) At the end of defrosting, the compressor and the fans remain still for the d7 set time, the defrosting icon flashes.	0 \div 10 min	0 min

F5	Fans pause after defrosting (minutes) Enables keeping the fans still for an F5 time after dripping. This time starts from the end of dripping. If dripping is not set, the fans pause at the end of defrosting.	0 ÷ 10 min	0 min
At1	Minimum temperature alarm Enables defining a minimum temperature value to the ambient. Below value At1, the alarm state will be signalled by the alarm icon flashing, the displayed temperature flashing and an internal buzzer acoustically signalling the existence of the anomaly. The alarm is signalled after the Ald time.	-45 ÷ At2-1 °C	-45°C
At2	Maximum temperature alarm Enables defining a maximum temperature value to the ambient. Above value At2, the alarm state will be signalled with the alarm icon flashing, the displayed temperature flashing and an internal buzzer acoustically signalling the existence of the anomaly. The alarm is signalled after the Ald time. The alarm does not suspend any defrosting in progress.	At1+1 ÷ 45 °C	+45°C
AU1	Minimum humidity alarm Enables defining a minimum humidity value to the ambient to be humidified. Below the AU1 value, the Eu alarm state will be signalled with the alarm icon flashing and the buzzer active. Silencing, the humidity and the alarm icon remain flashing. The alarm is signalled after the time (Ald).	1 ÷ AU2-1 Rh%	1 Rh%
AU2	Maximum humidity alarm Enables defining a maximum humidity value to the ambient to be humidified. Below the AU2 value, the Eu alarm state will be signalled with the alarm icon flashing and the buzzer active. Silencing, the humidity and the alarm icon remain flashing. The alarm is signalled after the time (Ald). AU2=99 does not signal the alarm.	AU1+1 ÷ 99 Rh%	99 Rh%
rA	Air change enabling in real time With rA=1 it is possible to set up to 6 air changes in real time during one day, through parameters rA1...rA6.	0 = Disabled 1 = Enabled	0
rA1 ... rA6	Air change times programming It is possible to set up to 6 times for the air changes. The previous value locks the subsequent one making them sequential.	00:00 ÷ 23:50	--
drA	Air change duration	0 ÷ 60 min	6 min
tEu	Evaporator probe temperature display (if dE =1 nothing is displayed)	temperature	read only

SECOND LEVEL PROGRAMMING (Installer level)

5.9

To access second level programming, keep the UP (▲), DOWN (▼) and LIGHT keys pressed for a few seconds.

When the first programming variable appears, the system automatically switches to stand-by.

1. Using the (▲) key or (▼) key, select the variable to be amended. After having selected the wanted variable, it will be possible:
2. To display its setting by pressing the SET key
3. To amend its setting by keeping the SET key pressed and by pressing one of the keys (▲) or (▼).
4. Once configuration values have been set, to exit the menu press keys (▲) and (▼) simultaneously, keeping them pressed for a few seconds, until the cell temperature value appears again.
5. Memorisation of the amendments made to the variables will happen automatically when exiting the configuration menu.
6. Press the STAND-BY key to enable the electronic control.

SECOND LEVEL VARIABLES LIST (Installer Level)

5.10

VARIABLES	MEANING	VALUES	DEFAULT
AC	Door swith input state (with door closed)	0 = normally open 1 = normally closed	0
Pc	Main alarm digital input state (9-18)	0 = NO 1 = NC	0 = NO
F3	Fans state when cold, hot, humidification and dehumidification are at a stand-still	0 = Fans in continuous start 1 = Fans switched-off if cold, hot, humidification and dehumidification switched-off	1
F4	Fans pause during defrosting	0 = Fans working during defrosting 1 = Fans not working during defrosting	1
F6	Evaporator fans activation for air recirculation. The fans activate for a time defined by F7 if they have not started working for the F6 time. If activation time coincides with the defrosting time, end of defrosting is awaited. The speed of the fans (high/low) is the same as that selected for the phase in progress.	0 – 240 min 0 = (function not activated)	0 min



F7	Evaporator fans activation duration for air recirculation. Functioning time of fans for F6	0-240 sec	0:00:10
F8	Fans speed during seasoning / preservation. The value of this variable is amended based on the setting during the last phase of a performed program.	0 = High speed 1 = Low speed (only if rin=1)	0
Pr	Refreshment period. Interval between one refreshment and the subsequent one. Refreshment is a work pause where cold, hot, humidifies and dehumidifies are disabled.	0 ÷ 24 hours (at 10 min steps) 0 = Disabled	0 h
dr	Refreshment phase duration.	1 ÷ 240 min	120 min
rin	K7 Multifunction relay function choice. (clamps 15 - 16)	0 = Refreshment 1 = Fans low speed	0
Ald	Signal delay and alarm display time of minimum or maximum temperature or humidity.	(1 min ÷ 4 hours)	120 min
C1	Minimum time between switch-off and subsequent compressor ignition. It also stops the fans if they are not active for other functions	0...15 min	0
dEU	Dehumidification mode selection The separate dehumidification calls hot and cold only for temperature	0 = cooling 1 = heating 2 = separate dehumidification	0
EnU	Humidification Enabling	0 = disabled 1 = enabled	1
End	Dehumidification Enabling	0 = disabled 1 = enabled	1
Cat	Ambient probe value correction	-10,0 ÷ +10,0 °C	0,0°C
CaU	Humidity probe value correction	-20 ÷ +20 RH%	0 %
EnH	Hot enabling	EnH = 1 hot enabled EnH = 0 hot disabled	1
Hr	Humidity management	Hr = 1 enables humidity management Hr = 0 disables humidity management. The humidity probe can be disconnected without error on display. The evaporator probe is displayed instead of humidity (if dE= 0)	1
dE	Evaporator probe exclusion	0 = probe present 1 = probe absent	1
d1	Type of defrosting: with cycle reverse (hot gas) or resistance. The compressor output is also activated with hot gas	1 = with hot gas 0 = with resistance	0
LSt	Minimum value attributable to setpoint of temperature	-45 ÷ HSt °C	-45°C
HSt	Maximum value attributable to setpoint of temperature	+45 ÷ LSt °C	+45°C

btF	Differential of temperature referred to Setpoint for COLD LOCK . It constitutes the SET-btF limit below which the cold call relay (3-4) and the Dehumidification relay (25-26) are disabled.	0 ÷ 20 °C 0 = Disabled	0
btC	Differential of temperature referred to Setpoint for HOT LOCK . It constitutes the SET+btC limit above which the hot call relay (5-6), the Humidification relay (11-12) and the Dehumidification relay (25-26) are disabled.	0 ÷ 20 °C 0 = Disabled	0
dEt	Limit time for DEHUMIDIFICATION . If the dehumidification request is not satisfied (reaching of humidity SET) within the time (dEt), the variable (dEO) is taken into consideration for the operation to be performed. Counting starts at every new dehumidification request.	(0 min ÷ 4 hours) (1 min steps) 0 = Disabled	0
dEo	Operation to be performed in case limit Timeout for dehumidification (dEt) intervenes. dEO = 0 an alarm signal (Ed) + buzzer + alarm relay is given. The alarm is displayed even when humidity set is achieved; it does not lock the normal functioning and once silenced, the dEt count re-starts. dEO = 1 a refreshment of the duration (dr) is launched and the timer relating to the interval (Pr), if present, is recharged.	0 = alarm only 1 = a refreshment is performed.	0
Ad	Net address for connection to supervision system TELENET.	0 ÷ 31	0
Aut	Automatic cycles management or via TeleNET. For managing the cycles via TeleNET to set Aut=1	0 = local cycles 1 = TeleNET management	0
Cg	Seasoning or germination selection	0 = seasoning cycles active 1 = germination day/night cycle active	0
CgA	Not used.	0	0
tg2	Not used.	0	0

P1	Password: type of protection. (Active when PA is different from 0).	0 = Total lock. It is possible to only see the temperature and humidity setpoint. 1 = Locks access in 1st and 2nd level programmes. Locks access in germination cycle amendment and programmes amendment. 2 = Locks access in 1st and 2nd level programmes. 3 = Locks access in 2nd level programmes.	3
PA	Protection password	0 – 999 0 = Disabled	0
dMY	Current date	dd:mm:yy	
HMS	Current time	0:00...23:59	
reL	release software	indicates the software version	(read only) 6

5.11

AUTOMATIC PROGRAMMES Pr1, Pr2, Pr3, Pr4, Pr5

To access the automatic programmes parameters, keep keys  START/STOP and  SET pressed for a few seconds (the function is active only if Cg=0).

- Using key (▲) or key (▼) select the program to be amended. After having selected the program, press the SET key to display the parameters.
- Using key (▲) or key (▼) select the parameter to be amended.
- Amend the setting by keeping the SET key pressed and by pressing one of the keys (▲) or (▼).
- Once configuration values have been set, to exit the menu press keys (▲) and (▼) simultaneously keeping them pressed for a few seconds, until the temperature value appears again.
- Memorisation of the amendments made to the variables will happen automatically when exiting the configuration menu. Exiting from the menu happens spontaneously after an inactivity period or by simultaneously pressing keys (▲) and (▼) for a few seconds.

The following table represents any one of the Pr1, Pr2, Pr3, Pr4, Pr5 programmes:

VARIABLES	MEANING	VALUES	DEFAULT
CIC	CIC=0 at the end of the last program phase (phase 5) it switches to manual. CIC=1 at the end of the last timed phase (phase 5) it returns to initial phase (phase 0). An infinite loop of the phases is therefore created. CIC=2 at the end of the last program phase (phase 5) it switches to the subsequent program.	0 = it ends the program and switches to manual. 1 = loop phases 2 = calls subsequent program	0
Sgt	Phase 0 or dripping phase temperature setpoint	-45,0 ÷ +45,0 °C	0,0°C
SgU	Phase 0 or dripping phase humidity setpoint	0...99 rH% 0 = disabled	60%
Sg	Dripping enabling	0 = normal functioning 1 = hot only enabled 2 = hot, cold only enabled	0
Sgr	Refreshment	0 = NO 1 = YES	0
vSg	Dripping phase evaporator fans speed. Amends the value of 2nd level variable (F8)	0 = High speed 1 = Low speed (only if rin=1)	0
tSg	Dripping phase duration	0:00...99:30 (at 30 min steps)	0:00
St1	Phase 1 temperature setpoint	-45,0 ÷ +45,0 °C	0,0°C
SU1	Phase 1 humidity setpoint	0...99 rH% 0 = Disabled	60
rn1	Phase 1 refreshment	0 = NO 1 = YES	0
v1	Phase 1 evaporator fans speed. Amends the value of 2nd level variable (F8)	0 = High speed 1 = Low speed (only if rin=1)	0
t1	Phase 1 duration	0:00...99:30 (at 30 min steps)	0:00
St2	Phase 2 temperature setpoint	-45,0 ÷ +45,0 °C	0,0°C
SU2	Phase 2 humidity setpoint	0...99 rH% 0 = Disabled	60%
rn2	Phase 2 refreshment	0 = NO 1 = YES	0
v2	Phase 2 evaporator fans speed. Amends the value of 2nd level variable (F8)	0 = High speed 1 = Low speed (only if rin=1)	0
t2	Phase 2 duration	0:00...99:30 (at 30 min steps)	0:00
St3	Phase 3 temperature setpoint	-45,0 ÷ +45,0 °C	0,0°C
SU3	Phase 3 humidity setpoint	0...99 rH% 0 = Disabled	60%

rn3	Phase 3 refreshment	0 = NO 1 = YES	0
v3	Phase 3 evaporator fans speed. Amends the value of 2nd level variable (F8)	0 = High speed 1 = Low speed (only if rin=1)	0
t3	Phase 3 duration	0:00...99:30 (at 30 min steps)	0:00
St4	Phase 4 temperature setpoint	-45,0 ÷ +45,0 °C	0,0°C
SU4	Phase 4 humidity setpoint	0...99 rH% 0 = Disabled	60%
rn4	Phase 4 refreshment	0 = NO 1 = YES	0
v4	Phase 4 evaporator fans speed. Amends the value of 2nd level variable (F8)	0 = High speed 1 = Low speed (only if rin=1)	0
t4	Phase 4 duration	0:00...99:30 (at 30 min steps)	0:00
St5	Phase 5 temperature setpoint	-45,0 ÷ +45,0 °C	0,0°C
SU5	Phase 5 humidity setpoint	0...99 rH% 0 = Disabled	60%
rn5	Phase 5 refreshment	0 = NO 1 = YES	0
v5	Phase 5 evaporator fans speed. Amends the value of 2nd level variable (F8)	0 = High speed 1 = Low speed (only if rin=1)	0
t5	Phase 5 duration	0:00...99:30 (at 30 min steps)	0:00
St	Seasoning / preservation temperature setpoint	-45,0 ÷ +45,0 °C	0,0°C
SU	Seasoning / preservation humidity setpoint	0...99 rH% 0 = Disabled	60%
tSC	Seasoning/preservation end timeout	0 ÷ 240 days	0
vSC	Seasoning/preservation evaporator fans speed. Amends the value of 2nd level variable (F8)	0 = High speed 1 = Low speed (only if rin=1)	0

5.12

GERMINATION DAY/NIGHT CYCLE

To access the day/night cycle parameters for germination lights it is necessary to:

1. Check that parameter Cg=1

2. Keep keys  (▼) DOWN and  LIGHT pressed for a few seconds.

3. Using key (▲) or key (▼) select the parameter to be amended.

4. Amend the setting by keeping the SET key pressed and by pressing one of the keys (▲) or (▼).

5. Memorisation of the amendments made to the variables will happen automatically when exiting the configuration menu. Exiting from the menu happens spontaneously after an inactivity period or by simultaneously pressing keys (▲) and (▼) for a few seconds.

VARIABLES	MEANING	VALUES	DEFAULT
tdS	Day phase start time. Germination lights active only during the day phase.	00:00 ÷ 23:50 (10 min steps)	0
tdE	Day phase end time. tdE can also be < of tdS; for example, a day phase can start at 10pm and end at 4pm of the following day.	00:00 ÷ 23:50 (10 min steps)	0
tt1	t1 Temperature SET start time.	00:00 ÷ 23:50 (10 min steps)	0
tt2	t2 Temperature SET start time.	00:00 ÷ 23:50 (10 min steps)	0
t1	Temperature 1 SET.	-45,0 ÷ +45,0 °C	0,0°C
t2	Temperature 2 SET.	-45,0 ÷ +45,0 °C	0,0°C

ELECTRONIC CONTROLLER VISION100 THR IGNITION

5.13

After having wired the electronic controller, apply voltage 230Vac; the control will immediately and simultaneously emit a sound for a few seconds and remain fully switched-on on the display.

COLD / HOT: AMBIENT TEMPERATURE MAINTENANCE

5.14

The cold and hot call is managed in neutral area depending on the set temperature setpoint (📄 key 4) and on the temperature differentials (parameters dtC and dtF). The cold is activated upon exceeding of set + dtF and remains active until set is reached (with dtn=0). The hot is activated below set - dtC and remains active until set is achieved (with dtn=0).

It is possible to set a "dead area" with dtn parameter that deactivates hot and cold when the temperature is between SET-dtn and SET+dtn.

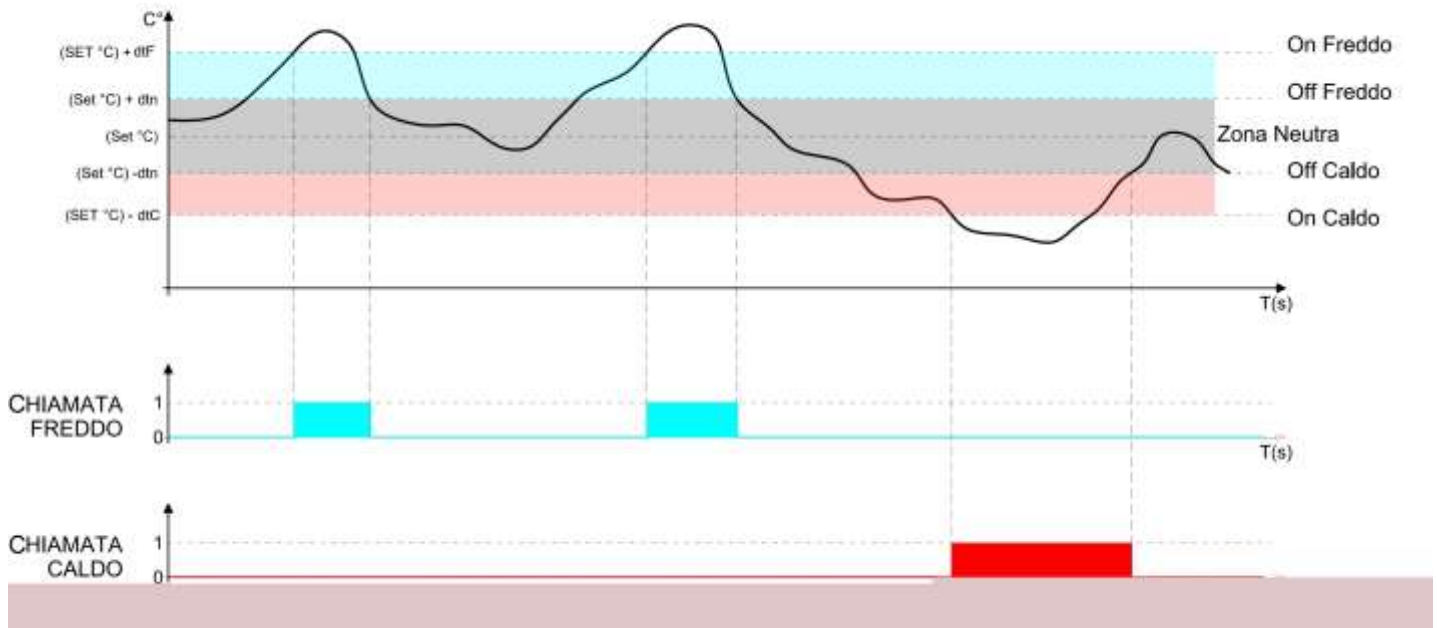

Parameter C1 introduces a delay between a switch-off and the subsequent re-activation of the cold. Hot can be deactivated with parameter EnH (EnH=0 disables the hot relay in all conditions).

5.15

HUMIDITY/DEHUMIDIFICATION: AMBIENT HUMIDITY MAINTENANCE

The humidity and the dehumidification call is managed in neutral area depending on the set humidity setpoint (📱 key 4) and by the humidity differentials (parameters dUU and dUd). Dehumidification is activated upon exceeding of set + dUd and remains active until set is reached (with dUn=0). Humidification is activated below set - dUU and remains active until set is reached (with dUn=0).

It is possible to set a "dead area" with parameter dUn that deactivates humidification and dehumidification when humidity is between SET-dUn and SET+dUn.

The humidity management can be excluded with parameter Hr.

Dehumidification only can be excluded with parameter End.

Humidification only can be excluded with parameter EnU.

There are three dehumidification modes (parameter dEU):

1. Dehumidifies with the cold (the cold is called to dehumidify, the hot is added only to maintain ambient temperature).

2. Dehumidifies with the hot (the hot is called to dehumidify, the cold is added only to maintain ambient temperature).
3. Separate dehumidification (only the dehumidification output activates but hot and cold are not called).

It is possible to give a maximum time for the dehumidification phase (parameter dEt) by signalling an alarm or forcing a refreshment (parameter dEo).

REGOLAZIONE UMIDITA'

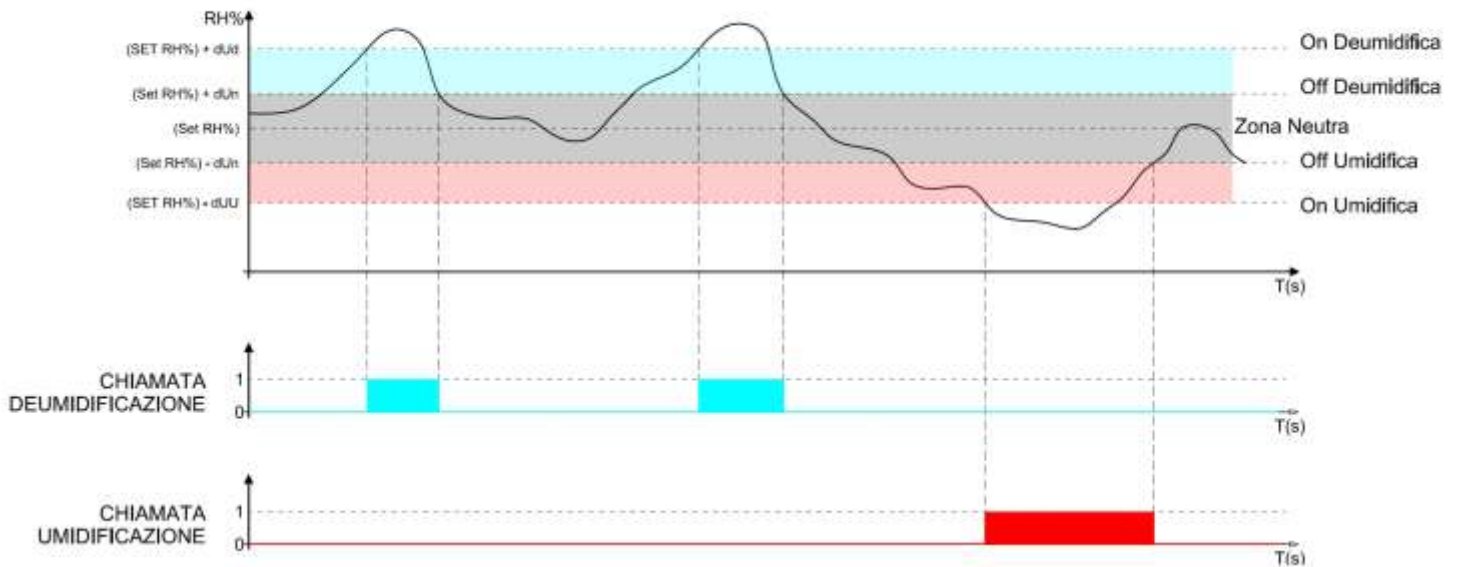

5.16

VENTILATION

The parameters of the second level programming F3, F4, F6, F7, F8 enable setting fans management in the different modes.

By setting parameter rin=1, it is possible to differentiate high and low speed of the fans in the various phases of a program (parameters vSg, v1, v2, v3, v4, v5, vSC).

5.17

AIR CHANGE

The air changes can be enabled with parameter rA. Up to six daily execution times for air change can be set in parameters from rA1 up to rA6.

The duration of the air change is defined by parameter drA.

During air change, hot, cold, humidity and dehumidification do not activate.

It is possible, at any time, to force an air change using the DOWN  key.

5.18

REFRESHMENT OR PAUSE

The refreshment is a phase of the pause process of the temperature and humidity management. Refreshments are managed with parameters Pr and dr.

Pr defines the interval between one refreshment and the subsequent one, dr defines refreshment duration.

It is possible, at any time, to force an air change using the UP key  (a defrosting is also simultaneously activated).

To interrupt a refreshment, position the control in stand-by (the times are reloaded).

5.19

DEFROSTING

Defrosting can be managed with parameters d4, d5, d6, d7, F5 that define the intervals, the maximum duration, the defrosting end temperature, the dripping and the fans stop. To manually activate defrosting it is sufficient to press the UP key . Defrosting is not activated in case the temperature set for defrosting end (d6) is lower than the temperature detected by the evaporator probe. Defrosting will complete upon reaching of the defrosting end temperature (d6) or for defrosting maximum duration (d5).

5.20

DEFROSTING WITH HOT GAS

Set parameter d1 = 1 for managing of cycle reverse defrosting.

The compressor relay and the defrosting relay are activated for the entire defrosting phase.

For correct plant management, it will be the responsibility of the installer to use the defrost output that must allow the opening of the cycle reverse solenoid valve and the closing of the liquid solenoid valve.

For the capillary plants (without thermostatic valve) it is sufficient to control the cycle reverse solenoid valve using the defrosting relay control.

PASSWORD FUNCTION

5.21

The password function activates by setting a value for parameter PA different from 0. See parameter P1 for the different protection levels.

Protection is enabled automatically after approx. 2 minutes of keyboard inactivity.

Numbers 000 appear on the display.

By keeping SET pressed, the first digit flashes for amendment using up/down arrow.

Release SET and press SET again: the second amendable digit flashes.

Release SET and press SET again: the third amendable digit flashes.

The operation is cyclical and therefore by pressing SET again, the first digit flashes again, and so-on.

If password is forgotten use universal number 100.

AUTOMATIC PROGRAMS

5.22

An automatic program is a work cycle made of a maximum of 7 phases in which it is possible to automatically amend the temperature and the humidity setpoint when switching from one phase to the subsequent one.

In each phase it is possible to choose whether to enable or not the movements (managed with parameters Pr and dr) and manage a different speed for the fans.

It is possible to set up to 5 programmes (identified with Pr1, Pr2, Pr3, Pr4, Pr5) each of which has a different setting according to the table of paragraph 5.10.

For each program, the first phase is defined dripping or phase 0; 5 process phases follow. The last phase is the seasoning/preserving phase with unlimited duration in time.

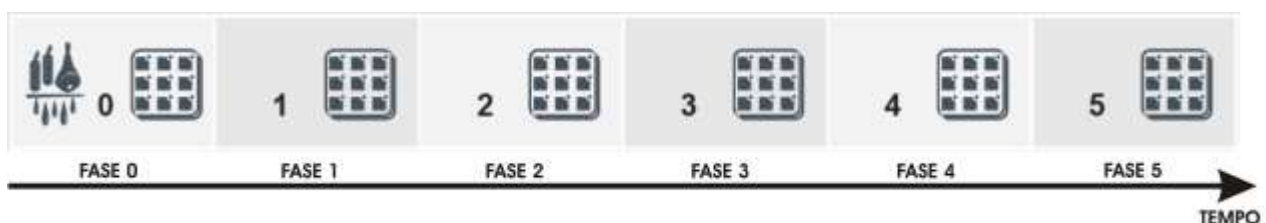



Each phase and the dripping are characterised by:

- Temperature setpoint.
- Humidity setpoint.
- Refreshments enabling/disabling.
- High or low fans speed.
- Phase duration (maximum 99 hours with 30 min steps).

For the dripping phase it is possible to exclude the humidity and the cold management.

The program starts by pressing the START key for a few seconds, the program selection by pressing the SET key.

Program start:

- 1) press the START  key for a few seconds.
- 2) using the UP and DOWN arrows select the wanted program.
- 3) press the SET  key to start the program.

The time evolution is highlighted by the advancing bars. During program execution, it is possible to amend the humidity and temperature setpoint directly from the keyboard without having to access programming. Variations are provisional and do not alter the pre-set program.

If a phase has 0 time, it moves on to the subsequent one.

The times of the phases proceed even in case of no electric power supply or control stand-by.

Using the START key (pressed briefly) it is possible to see the remaining time of the phase in progress.

With parameter CIC, it is possible to program a cycle (once the program has finished it automatically starts from the beginning) or to connect programmes between them, in order to have a greater number of phases of the 6 of the individual program.

A program can always be interrupted by pressing the START/STOP  key for a few seconds.

By setting parameter Cg (Germination/seasoning cycle) at second programming level, you can choose the use of the programs or a special program suitable for day/night cycles:

Cg = 0 (default) activates the automatic programmes management for seasoning;

Cg = 1 activates the management of the germination day/night cycle.

By means of the parameters indicated in paragraph 5.12, it is possible to determine the day start and end times and manage two differential temperature setpoint.

During the day phase, the germination lights are switched on and the display shows the references of phase 0 switched-on. During the night phase, the germination lights are switched-off and the references of phase 4 switch-on.

The connection of the germination lights is separate from the cell light that can be used as service light (managed as usual from the door switch and the light key).

The current refreshment relay will become with double function: if Cg = 1 is selected it is no longer the refreshment relay but becomes the relay of the germination lights.

The day/night cycle starts by pressing the cycle start key



CHAPTER 6: OPTIONS

6.1

TELENET SUPERVISION/MONITORING SYSTEM

To insert the board in a **TeleNET** network, refer to the layout below. To configure the instrument, refer to the **TeleNET** manual.

IMPORTANT: During configuration, select "Instrument PLUS 100 THR rel. 8 or higher" under the entry "Module".

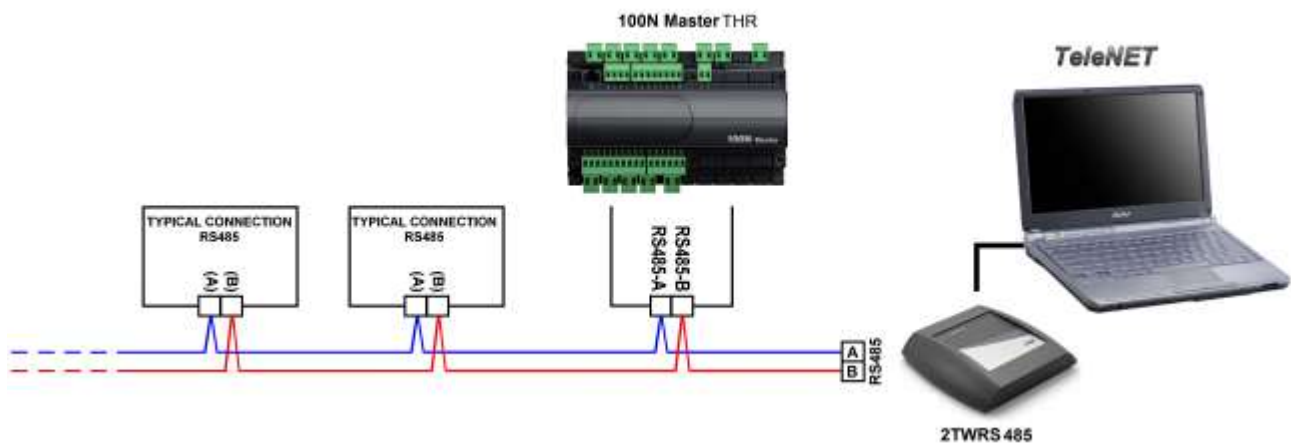

CHAPTER 7: DIAGNOSTIC

DIAGNOSTIC

7.1

In case of anomalies, the **VISION100 THR** controller warns the operator using alarm codes shown by the display and an acoustic signal emitted by a buzzer inside the Operational console. In case an alarm condition occurs, the display will show one of the following messages:

ALARM CODE	POSSIBLE CAUSE	OPERATION TO BE CARRIED OUT
E0	Functional anomaly of the ambient probe	<ul style="list-style-type: none"> • Check ambient probe state. • If problem persists, replace the probe.
E1	Functional anomaly of the humidity probe	<ul style="list-style-type: none"> • Check state and connection of humidity probe. • If problem persists, replace the probe.
E2	Functional anomaly of the defrosting probe (In this case, any defrosting will have d5 duration)	<ul style="list-style-type: none"> • Check defrosting probe state. • If problem persists, replace the probe.
E3	Eeprom alarm An error has been detected in the EEPROM memory (all outputs are deactivated except the alarm one).	<ul style="list-style-type: none"> • Switch the equipment off and on again.
E4	Software compatibility error	<ul style="list-style-type: none"> • Check correct combination between MASTER board and Console board.
E6	Low battery alarm	<ul style="list-style-type: none"> • Replace the Console lithium battery (CR2032 type).
Ec	Main alarm (e.g. Thermal protection or max. pressure switch) (All outputs are deactivated except the alarm output. if present)	<ul style="list-style-type: none"> • Check compressor absorption. • If problem persists, contact the after-sales technical assistance service.
En	No connection between Console and MASTER board.	<ul style="list-style-type: none"> • Check connection between the two units. • If problem persists, contact the after-sales technical assistance service.
Eu	Minimum or maximum humidity alarm. A humidity higher or lower to that set for minimum or maximum humidity alarm has been reached in the ambient (See variables AU1 and AU2, user programming level)	<ul style="list-style-type: none"> • Check humidity management. • The probe does not correctly detect the humidity.
Et + Temperature on display is flashing	Minimum or maximum temperature alarm. A temperature higher or lower to that set for minimum or maximum temperature alarm has been reached in the ambient (See variables At1 and At2, user programming level)	<ul style="list-style-type: none"> • Check the compressor state. • The probe incorrectly detects the temperature or the stop/start control of the compressor does not work.
Ed	Limit Timeout for dehumidification	<ul style="list-style-type: none"> • Check humidity management. • The probe does not correctly detect the humidity.

ATTACHMENTS**A.1****EU DECLARATION OF CONFORMITY**

LA PRESENTE DICHIARAZIONE DI CONFORMITA' E' RILASCIATA SOTTO LA RESPONSABILITA' ESCLUSIVA DEL FABBRICANTE:
THIS DECLARATION OF CONFORMITY IS ISSUED UNDER THE EXCLUSIVE RESPONSIBILITY OF THE MANUFACTURER:



PEGO S.r.l. Via Piacentina 6/b, 45030 Occhiobello (RO) – Italy –
 Società soggetta all'attività di direzione e coordinamento di Castel S.r.l.

DENOMINAZIONE DEL PRODOTTO IN OGGETTO / DENOMINATION OF THE PRODUCT IN OBJECT

MOD.: **VISION100 THR**

IL PRODOTTO DI CUI SOPRA E' CONFORME ALLA PERTINENTE NORMATIVA DI ARMONIZZAZIONE DELL'UNIONE EUROPEA:
THE PRODUCT IS IN CONFORMITY WITH THE RELEVANT EUROPEAN HARMONIZATION LEGISLATION:

Direttiva Bassa Tensione (LVD):	2014/35/UE
<i>Low voltage directive (LVD):</i>	2014/35/EU
Direttiva EMC:	2014/30/UE
<i>Electromagnetic compatibility (EMC):</i>	2014/30/EU

LA CONFORMITA' PRESCRITTA DALLA DIRETTIVA E' GARANTITA DALL'ADEMPIMENTO A TUTTI GLI EFFETTI DELLE SEGUENTI NORME:
THE CONFORMITY REQUIRED BY THE DIRECTIVE IS GUARANTEED BY THE FULFILLMENT TO THE FOLLOWING STANDARDS:

Norme armonizzate: **EN 60730-1:2011, EN 60730-2-9:2010, EN 61000-6-1:2007, EN 61000-6-3:2007**
 European standards: **EN 60730-1:2011, EN 60730-2-9:2010, EN 61000-6-1:2007, EN 61000-6-3:2007**

IL PRODOTTO E' COSTITUITO PER ESSERE INCORPORATO IN UNA MACCHINA O PER ESSERE ASSEMBLATO CON ALTRI MACCHINARI PER COSTITUIRE UNA MACCHINA CONSIDERATE DALLA DIRETTIVA: 2006/42/CE "Direttiva Macchine".

THE PRODUCT HAS BEEN MANUFACTURED TO BE INCLUDED IN A MACHINE OR TO BE ASSEMBLED TOGETHER WITH OTHER MACHINERY TO COMPLETE A MACHINE ACCORDING TO DIRECTIVE: EC/2006/42 "Machinery Directive".

Firmato per nome e per conto di:
Signed for and on behalf of:

Pego S.r.l.
Martino Villa
Presidente

Luogo e Data del rilascio:
Place and Date of Release:

Occhiobello (RO), 01/01/2020

VISION100 THR CONNECTION LAYOUT

A.2

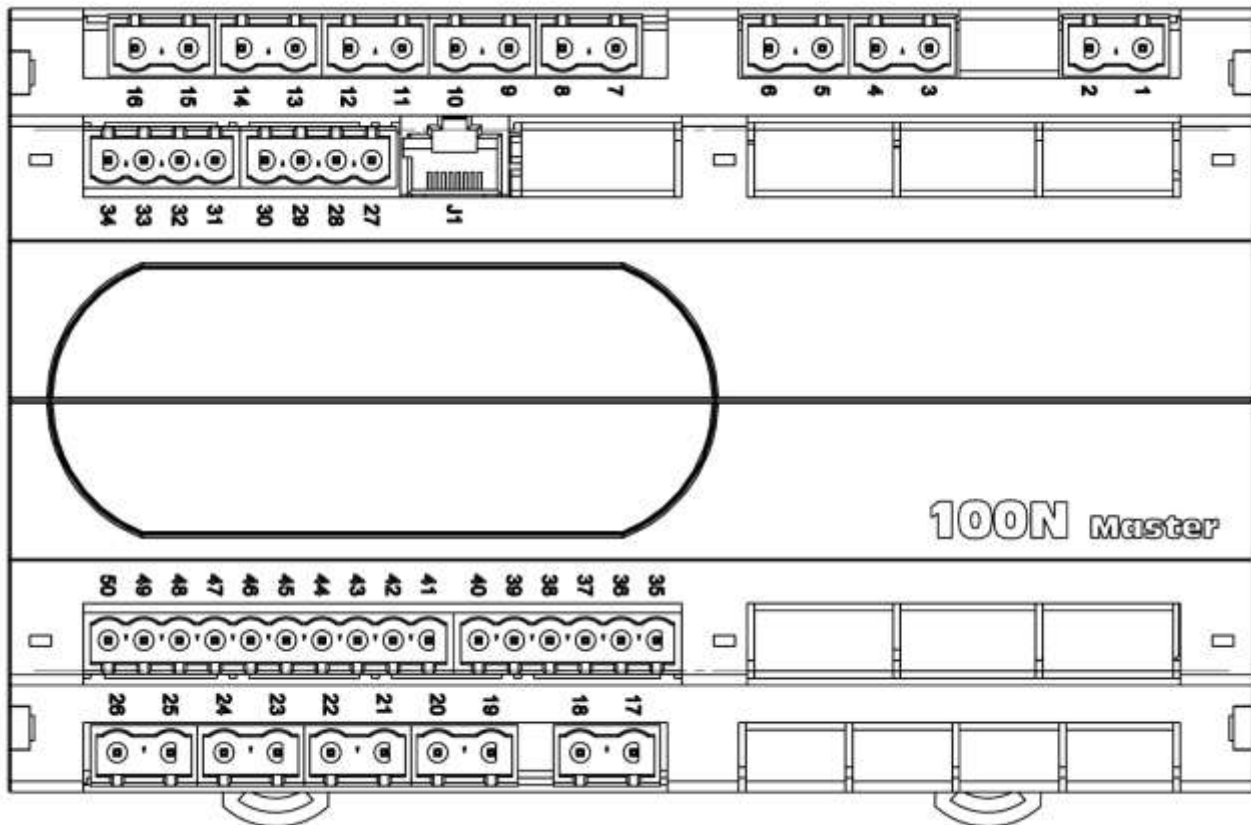
**Power supply section**

1-2 Power supply 230VAC 50/60 Hz

Analogical inputs section

29-30 Evaporator NTC probe

31-32 Humidity probe 4-20 mA
(0-100Rh%) (32=V+ 31=Y)

27-28 Ambient NTC probe

Digital inputs section

45-50 Stand by forcing

44-50 Disables hot (forces variable
EnH=0)43-50 Disables humidity (forces variable
Hr=0)

42-50 Door switch

41-50 Main alarm (stops all outputs)

Console section35-36 $\pm 12V$

37-38 RS485 console

Outputs section (contacts without voltage)

21-22 Alarm

23-24 Defrost

25-26 Dehumidification

15-16 Refreshment (rin=0)/ low speed fans
(rin=1) / Step 1 germin. lights (Cg=1)

13-14 Air change

11-12 Humidification

9-10 Cell light

7-8 Fans (high speed if rin=1)

5-6 Hot

3-4 Cold

TeleNET Section:

39 line A or clamp 3 of TWRS485

40 line B or clamp 4 of TWRS485



PEGO s.r.l.

Via Piacentina, 6/b 45030 Occhiobello ROVIGO – ITALY

Tel. +39 0425 762906 Fax +39 0425 762905

e-mail: info@pego.it – www.pego.it

AFTER-SALES ASSISTANCE SERVICE

Tel. +39 0425 762906 e-mail: tecnico@pego.it

Distributor: