

SUNK-ELECTRODE HUMIDIFIERS EASYSYSTEM ES100



Use and maintenance manual

READ AND KEEP

Thank you for having chosen a PEGO EASYSTEAM sunk-electrode humidifier.

Reading this manual in full will enable you to correctly install the machine and make better use of it. It is therefore advised to keep this manual near the humidifier for eventual maintenance operations and functioning amendments.

How to read the manual.

Graphic indications with the following meanings have been inserted to facilitate reading:



Indicates a note requiring careful reading.



Indicates the operations to be scrupulously performed to avoid damaging the humidifier, injuring persons or any malfunctionings.



Indicates the operations not to be performed to avoid damaging the humidifier, injuring persons or any malfunctionings.



Indicates a suggestion.



Indicates to contact the PEGO HUMIDIFIERS DIVISION after-sales assistance centre reported at the back of this manual.

Instructions for disposal:

The humidifier is made up of metal parts and plastic parts. In reference to European Union directive 2012/19/EC issued on 4 July 2012 and the related national legislation, please note that:

- A. WEEE cannot be disposed of as municipal waste and such waste must be collected and disposed of separately.
- B. The public or private waste collection systems defined by local legislation must be used. In addition, the equipment can be returned to the distributor at the end of its working life when buying new equipment.
- C. The equipment may contain hazardous substances: the improper use or incorrect disposal of such may have negative effects on human health and on the environment.



- D. The symbol  (crossed-out wheeled bin) shown on the product and on the user manual indicates that the equipment has been introduced onto the market after 13 August 2005 and that it must be disposed of separately.
- E. In the event of illegal disposal of electrical and electronic waste, the penalties are specified by local waste disposal legislation.

TABLE OF CONTENTS

INTRODUCTION

CHAP. 1

Page 5	1.1	Generality
Page 6	1.2	Warranty conditions
Page 7	1.3	Functioning principle
Page 9	1.4	ES100 Series humidifiers identification codes
Page 9	1.5	ES100 Series humidifiers technical data
Page 10	1.6	Overall dimensions
Page 11	1.7	Identification data
Page 11	1.8	Standard equipment

INSTALLATION

CHAP. 2

	Page 12	2.1	Main installation warnings
	Page 14	2.2	Installing the ES100 series humidifier
	Page 18	2.3	ES100 series humidifiers safety devices and power supply electric connections
	Page 18	2.4	ES100 series sensors and control signals connections
	Page 23	2.5	Digital inputs on HUM2 board
	Page 24	2.6	Digital outputs on HUM2 board
	Page 24	2.7	TA Inputs for measuring current absorption
	Page 24	2.8	Board power supply
	Page 24	2.9	NANO EasySTEAM Display for Master HUM2 board
	Page 25	2.10	ES100 series electrical layouts

PROGRAMMING

CHAP. 3

	Page 27	3.1	NANO EasySTEAM Controller description
	Page 28	3.2	Combination of keys
	Page 29	3.3	Status LED on master HUM2 electronics
	Page 30	3.4	1st Level programming
	Page 31	3.5	2nd Level programming

MASTER/SLAVE CONFIGURATION

CHAP. 4

Page 35	4.1	Individual humidifier configuration
Page 35	4.2	Master/Slave humidifiers configuration

HUMIDIFIER IGNITION

CHAP. 5

Page 38	5.1	Commissioning
Page 38	5.2	Steam output

DIAGNOSTICS

CHAP. 6

Page 39		Diagnostics
---------	--	-------------



MAINTENANCE

CHAP. 7

Page 42	7.1	Maintenance
Page 42	7.2	General and safety Standards
Page 42	7.3	Maintenance intervals
Page 44	7.4	Replacing the cylinder
Page 47	7.5	Cleaning the cylinder

STEAM DISTRIBUTION

CHAP. 8

Page 48	8.1	Generality
Page 48	8.2	Example of distribution in duct
Page 49	8.3	Example of distribution in ambient
Page 49	8.4	Choosing a steam distributor

ATTACHMENTS

CHAP. 9

Page 50	9.1	EU Declaration of conformity
Page 51	9.2	ES Series spare parts

CHAP. 1 INTRODUCTION**1.1****GENERALITY**

The family of Pego EASYSTEAM sunk-electrode humidifiers is the latest conception on the humidifiers market and can be considered the most complete for use type and easy maintenance.

The line includes humidifiers with 3kg/h and 6kg/h capacity with single-phase electric power supply, 6kg/h, 12kg/h, 24kg/h, 48kg/h, 96kg/h (ES100) with three-phase+neutral electric power supply; all able to work in ON/OFF mode, proportional mode with integrated humidostat and 4-20mA or 0-10V probe, proportional mode with outdoor 0-10V signal, in ON/OFF mode from integrated thermostat.

The EASYSTEAM humidifiers are provided with a microprocessor software enabling the widest programming for a fully customised use and a completely automatic functioning.

In fact, it is possible to set the maximum steam supply capacity, intermediate capacity values in percentage, discharge frequency for disturbance, water discharge for non-use.

The EASYSTEAM line is also provided with a display (2 on ES100) for real time viewing of the humidity in the premises to be treated; the current absorbed by the electrodes, the hours of work, various alarms, water charging and discharging as well as all easily settable programming parameters.

An acoustic alarm (buzzer) is present in the EASYSTEAM humidifiers that warns the user of any anomalies; the internal software is able to evaluate the seriousness of the anomaly, blocking the machine or continuing the steam supply.

The strength of the EASYSTEAM line is the simplicity with which the cylinder is replaced when normal wear makes it necessary.



The **EASYSTEAM** series humidifiers are covered by a 24-months warranty against all manufacturing defects as from the date indicated on the product ID code.

In case of defect the product must be appropriately packaged and sent to our production plant or to any authorized Service Center with the prior request of the Return Authorization Number.

Customers are entitled to have defective products repaired, spare parts and labour included. The costs and the risks of transport are at the total charge of the Customer.

Any warranty action does not extend or renew its expiration.

The Warranty does not cover:

- Damages resulting from tampering, impact or improper installation of the humidifier and its accessories.
- Installation, use or maintenance that does not comply with the instructions provided with the humidifier.
- Repair work carried out by unauthorized personnel.
- Consumables (sunk-electrode cylinders).
- Damages due to natural phenomena such as lightning, natural disasters, etc.

In all these cases the costs for repair will be charged to the customer.

The intervention service in warranty can be refused when the equipment is modified or transformed.

Under no circumstances **Pego S.r.l.** will be liable for any loss of data and information, costs of goods or substitute services, damage to property, people or animals, loss of sales or earnings, business interruption, any direct, indirect, incidental, consequential, damaging, punitive, special or consequential damages, in any way whatsoever caused, whether they are contractual, extra contractual or due to negligence or other liability arising from the use of the product or its installation.

Malfunction caused by tampering, bumps, inadequate installation automatically declines the warranty. It is compulsory to observe all the instructions in this manual and the operating conditions of the product.

Pego S.r.l. disclaims any liability for possible inaccuracies contained in this manual if due to errors in printing or transcription.

Pego S.r.l. reserves the right to make changes to its products which it deems necessary or useful without affecting its essential characteristics.

Each new release of the Pego product user manual replaces all the previous ones.

As far as not expressly indicated, is applicable the Law and in particular the art. 1512 C.C. (Italian Civil Code).

For any controversy is elected and recognized by the parties the jurisdiction of the Court of Rovigo.

1.3

FUNCTIONING PRINCIPLE

The EASYSTEAM series sunk-electrode humidifiers use the conductivity of potable water to produce steam by boiling.

A current is generated between the electrodes sunk in appropriate cylinder, that heats the water to the boiling point.

Current intensity (expressed in amperes) varies according to the quantity of water in cylinder that is in contact with the electrodes surfaces and the conductivity of the water itself.

The electronics in the humidifier, via an amperometric transformer, measures current intensity and controls the water charge valve to raise the water level or the discharge pump to lower it. This system is fully automatic.

Combined use of the microprocessor and a humidity sensor also makes it possible to set proportional functioning, optimising water and electricity consumption according to required humidity levels.

In addition to ensuring functioning during steam output, the discharge pump also guarantees draining the cylinder completely when the unit has been idle for a set time: this prevents forming and depositing of limescale or other particles created during the boiling process.

The EASYSTEAM series humidifiers are fully automatic and require only replacement of the cylinder when the electrodes are worn.

The layout below illustrates the functioning principle.

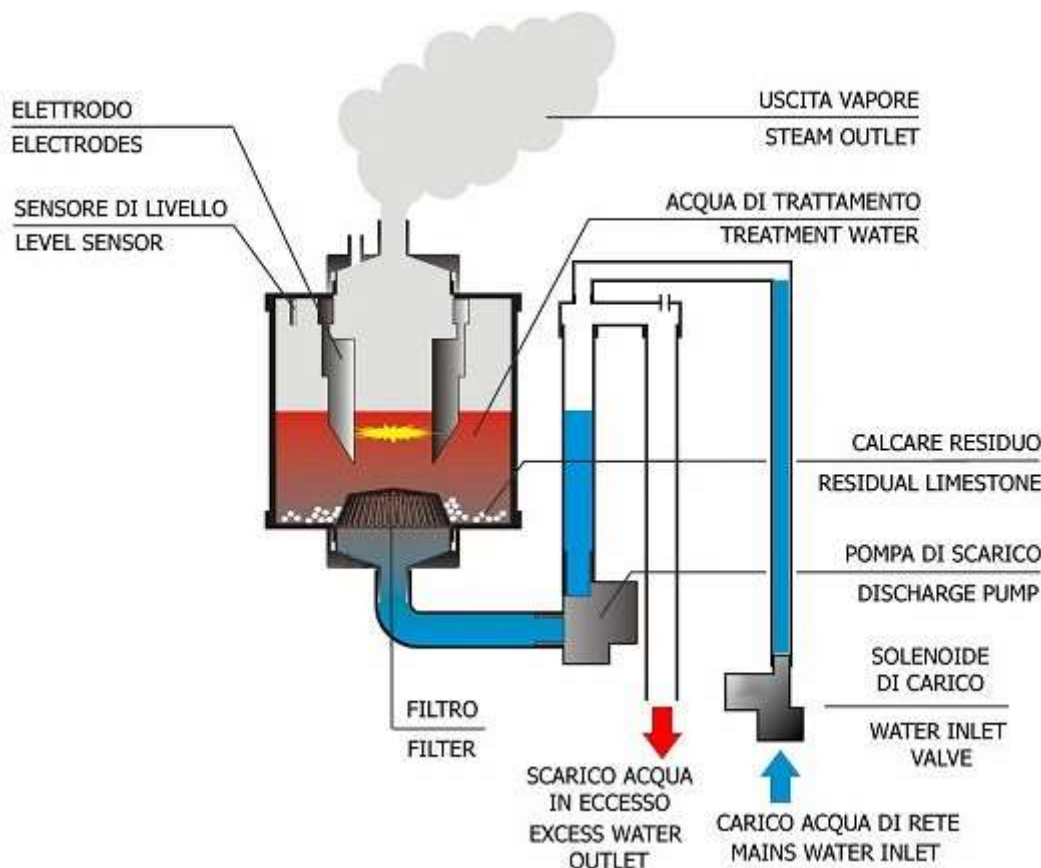

The supplied steam is managed proportionally upon steam output request that the electronic control calculates depending on the chosen functioning among the eight available,

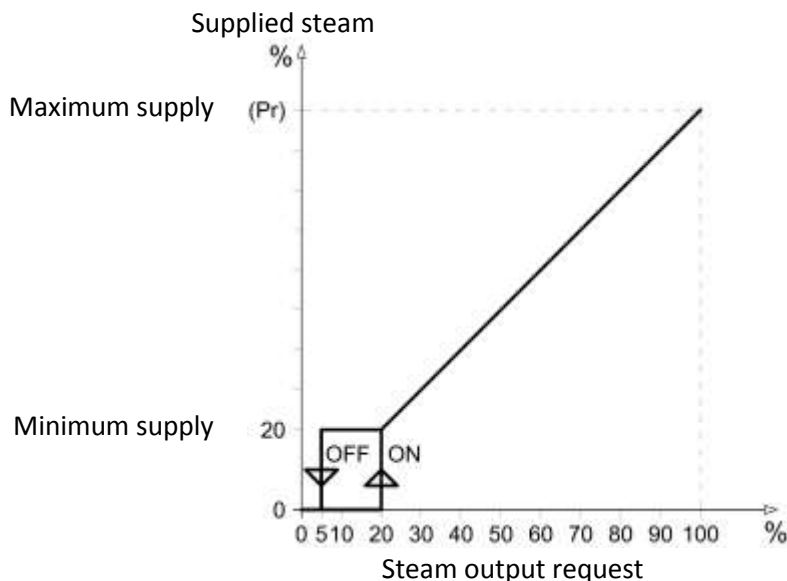

described in chap. 2.4. The minimum steam supply is fixed at 20% and is managed with an activation hysteresis; the maximum supply had in correspondence with a maximum requested output, corresponds to the percentage set in the first level variable (Pr). If, for example, on an ES100 producing 96kg/h of Pr steam 100% is set, maximum supply will be 96kg/h; but if Pr is reduced to 50%, maximum supply will be 48kg/h.



To ensure correct humidifier functioning, use only mains potable water; this because it is free from any toxic content and is compatible with the conductivity range needed for optimal humidifier functioning. However, in some geographical areas mains water may be unsuitable for optimal functioning due to very low or too high or too aggressive conductivity; the below is a summary table of the parameters required for correct humidifier functioning.

POTABLE WATER FUNCTIONING RANGE		LIMITS	
PARAMETER	UNIT OF MEASURE	MIN	MAX
* Water conductivity at 20°C	µS/cm	250	1300
Hardness	mg/l CaCO ₃	160	450
Chlorine	mg/l Cl ₂	0	0,2
Chlorides	ppm Cl ⁻	0	25
Calcium sulphate	mg/l CaSO ₄	0	95
Metal impurities/Solvents/Soaps/Lubricants	mg/l	0	0
Temperature	°C	+1	+40

* Water conductivity is always expressed at 20°C; bear in mind that conductivity decreases as water temperature drops and so water may not be very conductive during winter when mains water is particularly cold.



To overcome this problem, decrease the produced steam percentage described in chapter 3, PROGRAMMING, in this manual.



Do not supply the humidifier with well water or treated with osmosis purifiers, demineralisers or softeners or taken from cooling circuits.

1.4
ES100 SERIES HUMIDIFIERS IDENTIFICATION CODES
400ES100N

Three-phases covered humidifier with 96kg/h steam supply capacity, integrated electronics and eight selectable functioning modes.

1.5
ES100 SERIES HUMIDIFIERS TECHNICAL DATA

TECHNICAL DATA AND WORKING CONDITIONS	400ES100N
STEAM OUTPUT (in kg/h)	96
ELECTRIC POWER SUPPLY	400V 3/N 50-60HZ
POWER (kW)	71
ABSORBED CURRENT (A)	102
TYPE OF CONTROL	2 Display NANO + 2 Master HUM2 EASYSTEAM series
ELECTRONIC CONTROL POWER SUPPLY	230V 50-60HZ
STEAM OUTLET DIAMETER (mm)	40
CYLINDERS NUMBER	4
VACUUM WEIGHT (kg)	80
WEIGHT WITH OPERATIONAL UNIT (kg)	160
WATER SUPPLY PRESSURE	1-10 bar
FUNCTIONING AMBIENT TEMP.	+1 ÷ +40 °C
FUNCTIONING AMBIENT HUMIDITY	< 60 %RH (90 %RH non condensing)
STORAGE TEMPERATURE	-10 ÷ +70 °C
PROTECTION RATING	IP20

ES100

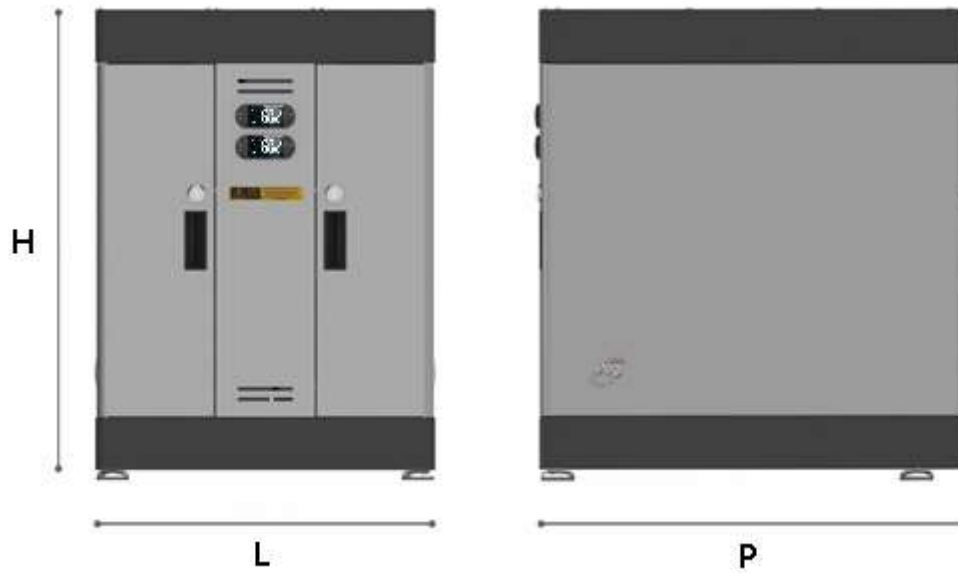

TYPE	400ES100N
W	526
D	670
H	730

Measurements in mm.

1.7

IDENTIFICATION DATA

The appliance described in this manual is provided with a plate on the side reporting the identification data of the same:

- Manufacturer Name
- Code of appliance
- Serial Number
- Power supply voltage
- Nominal current

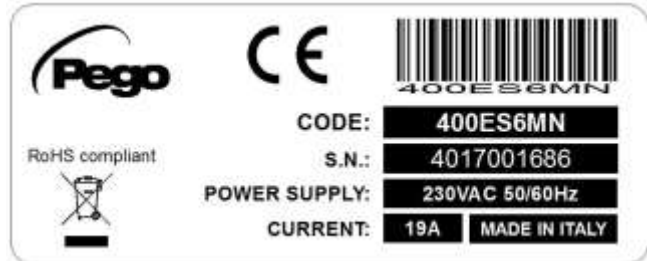

1.8

STANDARD EQUIPMENT

For assembly and use, the EASYSTEAM line humidifiers are provided with:

N° 1 Connection of 3/4 gas for water charging.

N° 1 Connection with 40mm external diameter for water discharge with fastening strap.

N° 4 Connection with 40mm external diameter for the steam tube with relative fastening strap.

N° 1 User manual.

N° 1 Test checklist reporting:

- Humidifier model.
- Default configuration.
- Steam output at 100%.
- Electric power supply type.
- Absorbed power in kW.
- Nominal absorbed current.

CHAP. 2 INSTALLATION**2.1****MAIN INSTALLATION WARNINGS**

1. The installation, maintenance and use of the appliance must be carried out by qualified personnel able to safely perform the requested operations.
Carefully read this manual before performing any operations and follow all its indications.
2. Install the appliance as close as possible to the ambient where steam is to be distributed; position with minimum steam tube distance, it is advised not to exceed 15 meters.
3. Install the appliance at a height enabling easy access to the control unit for parameters adjustment and display viewing. A height of about 1 meter from the ground is advised.
4. Install the appliance at a height enabling easy access to inside the humidifier for the replacement of the cylinder.
5. During functioning, certain humidifier parts, can exceed 60°C. Ensure the surfaces in contact with it, are compatible with such values.
6. Do not install and use the humidifier near products or objects that can damage in contact with water or humidity produced.
7. Avoid housing power supply cables in the same ducts with signal cables (probes and digital inputs).
8. Reduce the lengths of the connection cables as much as possible, avoiding the wiring assuming the spiral shape, damaging for possible inductive effects on the electronics.
9. Envision a general protection magnetothermic switch upstream of the humidifier.
10. All conductors used in the wiring, must be proportioned to support the load they must power.
11. If necessary to extend the probe, use suitably sectioned conductors and, however, not below 1mm².
12. Connect a pipe with a diameter of not less than 40mm and suitable for temperatures not less than 100°C, to the drain hose. This pipe must be firmly clamped to the drain sleeve and have vertical development for at least the first 50cm. Make sure that you do not create bottlenecks and do not exceed the height at any point in the path, the level of the drain sleeve.
13. For water charging, use only potable water with a pressure between 1 and 10 bar.

14. Before starting the humidifier, check default setting on the selected functioning mode indicated in the attached CHECK LIST test sheet; should default setting be different to own requirements, set software setting as indicated in chapter 3 and in accordance with the connections indicated in chapter 2.4.
15. For the humidifier to work it requires enabling to digital input 1 by means of a potential free contact (clamps 24 and 25 on the Master HUM2 microprocessor board), regardless of the selected functioning mode.
16. Should it not be necessary to use an external enabling, jump clamps 24 and 25 on the Master HUM2 microprocessor board.
17. Without enabling, the display alternates the OFF writing with normal displaying.

2.2**INSTALLING THE ES100 SERIES HUMIDIFIER**

1. Extract the humidifier from its packaging keeping it in vertical position, remove the nylon protective bag and check appliance integrity.
2. Lean the humidifier on the floor or on an adequate support by using the four adjustable small feet (see fig. 1).

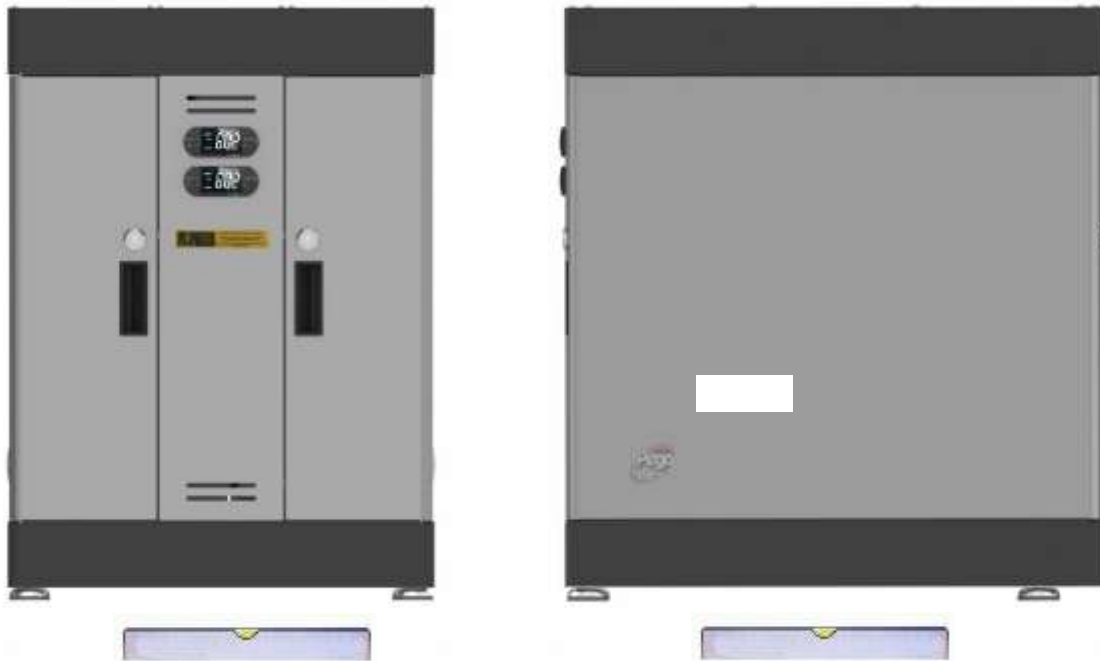

Fig. 1

3. Release the safety locks at the sides of lateral cover using a screwdriver (fig. 4, 5 e 6).



Fig. 4



Fig. 5

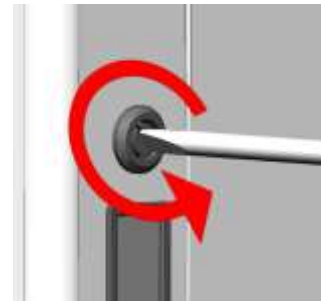

Fig. 6

4. Remove the lateral cover by gripping the two handles on the sides and slightly pulling towards you (fig. 7).



Fig. 7

5. Remove the 4 protective cardboard above the cylinder (fig. 8).



Fig. 8

6. Connect the water discharge tube to the 40mm diameter sleeve on the back side, fixing it with the provided strap (fig. 9 e 10).



Fig. 9

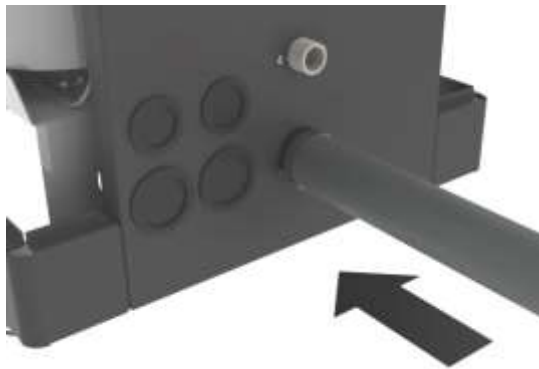

Fig. 10



Connect a pipe with a diameter of not less than 40mm and suitable for temperatures not less than 100°C, to the drain hose. This pipe must be firmly clamped to the drain sleeve and have vertical development for at least the first 50cm. Make sure that you do not create bottlenecks and do not exceed the height at any point in the path, the level of the drain sleeve.



NEVER WORK THE HUMIDIFIER IF THE DISCHARGE LINE IS NOT CORRECTLY CONNECTED!

7. Connect the water charge line to GAS $\frac{3}{4}$ coupling of the electrovalve located up the water discharge tube (fig. 11 e 12).

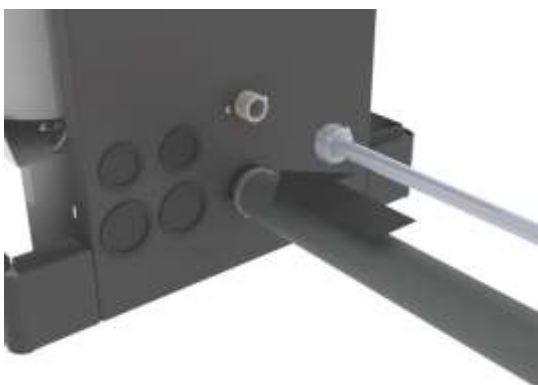

Fig. 11

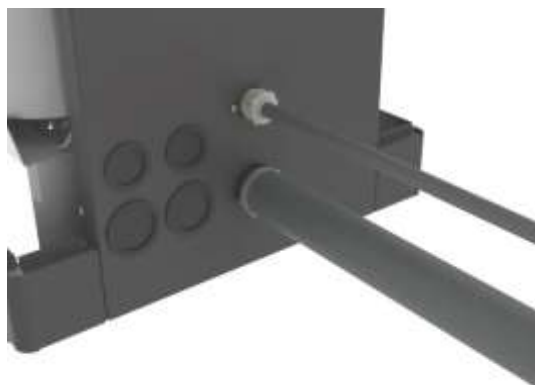

Fig. 12



Connect the water charge with a non metal piping, e.g. rubber, PVC, polypropylene, nylon, etc.

8. Connect the steam tubes in the cylinder flange sleeve fixing it with the provided strap (fig. 13, e 14).

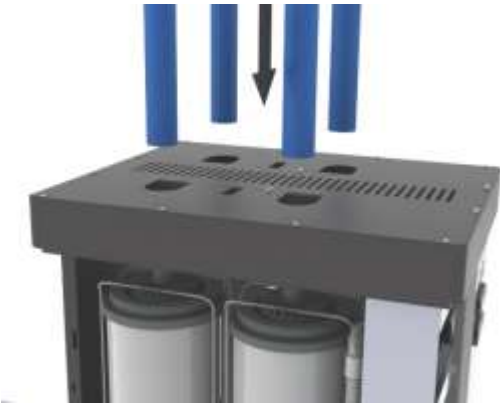

Fig. 13



Fig. 14



Use only PEGO HUMIDIFIERS steam tube or other tube with certification guaranteeing use with high temperatures without internal vulcanisation processes and release of toxic substances!



DO NOT MAKE THROTTLES, SIPHONS OR LENGTHS GREATER THAN 5 METRES!



To correctly connect the steam distribution line, carefully read chapter 8, STEAM DISTRIBUTION.

ES SERIES HUMIDIFIERS SAFETY DEVICES AND POWER SUPPLY ELECTRIC CONNECTIONS

2.3



Connect the electric power supply to the humidifier terminal box bringing 400V voltage + neutral to the RST and N clamps for the three-phase models.

It is compulsory to connect the yellow/green clamp with initial PE to the earth system of the electric mains. If required, check earth system efficiency.

Leave jump in clamps 60 and 61 of the terminal box or, if required, replace it with a normally closed emergency contact.

Clamps 62 - 63 e 162 - 163 of the terminal box are arranged for fan unit power supply; in case of unit installation, consult the use manual attached thereto.

2.4

ES100 SERIES SENSORS AND CONTROL SIGNALS CONNECTIONS

The humidifier envisions eight different functioning mode settable from S9 software variable described in chapter 3.5 and from specific electric connections.

Also necessary is the enabling to In1 digital input clamps 24 and 25 on the MasterHUM2 microprocessor board for all functioning mode (enabling = closed contact between clamps 24 and 25). Without enabling, the display alternates the OFF writing with normal displaying.

Below are the specific connections for every functioning mode.



If wanting to connect the humidifier with humidity probes not supplied by PEGO s.r.l., contact the after-sales assistance centre to verify hardware compatibility of the probe with the humidifier.

- [S9=0] ON/OFF Functioning:

This type of functioning envisions steam output in 2 ways only: no output or maximum output. The consent is usually given by a potential free contact coming from an electrical panel which, in turn, is controlled by a humidostat. Set the second level variable **S9=0** and connect the consent to clamps **24** and **25** of the Master HUM2 board (Enabling present with closed contact).

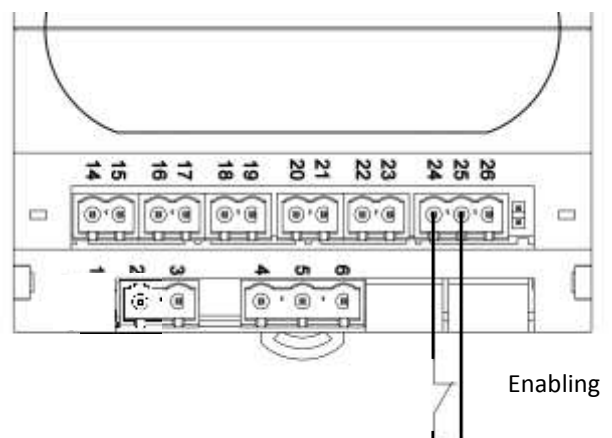
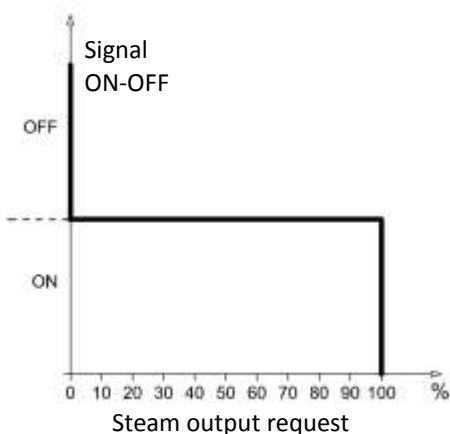

- [S9=1] **PROPORTIONAL functioning with 4-20mA ambient humidity probe (INTEGRATED HUMIDOSTAT):**

This type of functioning envisions proportional steam output; the humidifier will automatically regulate the steam output based on the request in ambient depending on set set. Consent is given by a 4-20mA (0-100%RH) humidity probe that, as well as regulate steam output, enables displaying relative humidity in ambient, directly on humidifier display. Set the second level variable **S9=1** and connect signal 4-20mA of the humidity probe to clamps **14** and **15**; in particular, connect the RH signal to clamp **14**, connect +V to clamp **15**.

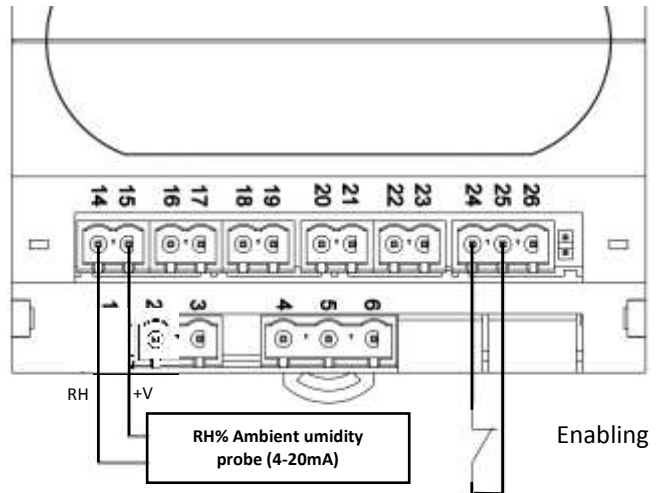
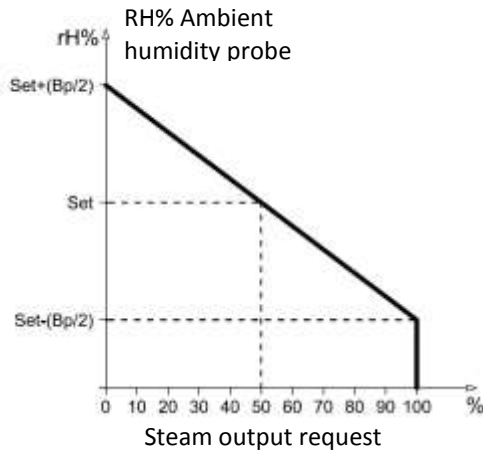

The Bp proportional band is the percentage value of the humidity around the set point; within this value the humidifier works proportionally. Example: if the proportional band is set on default value 10% ($\pm 5\%$ set point value) and humidity is set at 50%, below 45% the humidifier will work at 100% of steam output; above 55%, the humidifier will not produce steam. Between 45% and 55%, the humidifier will optimally regulate steam output.

- [S9=2] **PROPORTIONAL functioning with 0-10Vdc signal of reference:**

This type of functioning envisions steam output proportionally to 0-10Vdc signal of reference. Example: a 6Vdc signal of reference ensures the humidifier produced 60% of steam output referred to Pr software variable. So if Pr= 70%, steam output will be 42%. Set the second level variable **S9=2** and connect signal of reference 0-10V to clamps **16** and **17**; in particular, connect VRH (0-10Vdc probe output) to clamp 16, and GND mass to clamp 17.

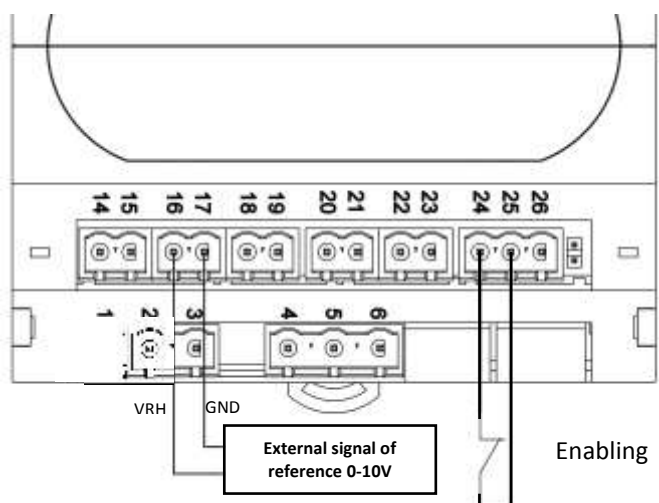
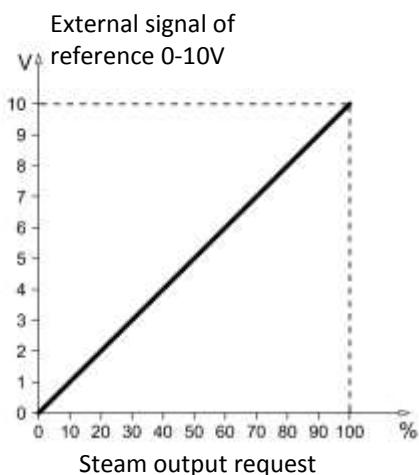

- [S9=3] **PROPORTIONAL functioning with 4-20mA ambient humidity probe + 4-20mA limit channel probe (INTEGRATED HUMIDOSTAT):**

This type of functioning envisions proportional steam output; the humidifier will automatically regulate the steam output based on the request in ambient depending on set set and the value measured in duct.

Set the second level variable **S9=3**, connect signal 4-20mA of ambient humidity probe (0-100%RH) to clamps **14** and **15**; in particular, connect RH signal to clamp **14** and +V to clamp **15**. Connect signal 4-20mA of channel probe (0-100%RH) to clamps **20** and **21**; in particular, connect signal RH to clamp **20** and +V to clamp **21**. For further clarification on the channel probe, refer to chapter 3 on programming (variables StC, r0, t1).

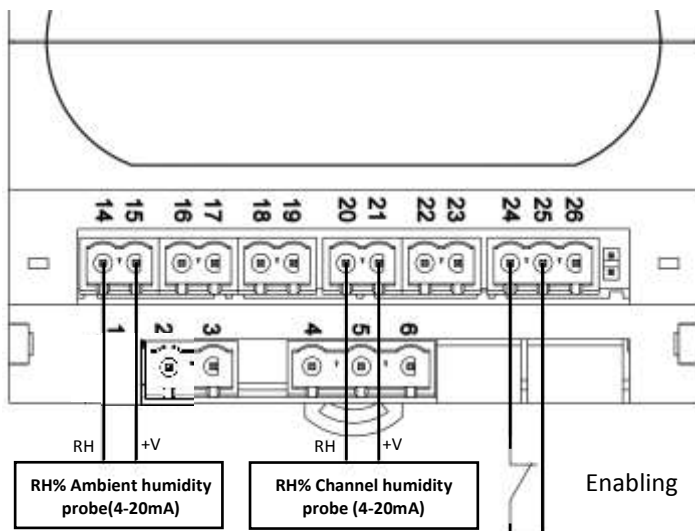

- [S9=4] **PROPORTIONAL functioning with 0-10Vdc signal of reference + limit channel probe (4-20mA):**

This type of functioning envisions steam output proportionally to 0-10Vdc signal of reference and to humidity measured in duct.

Set the second level variable **S94** and connect signal of reference 0-10Vdc to clamps **16** and **17**; in particular, connect VRH to clamp **16** and GND mass to clamp **17**. Connect channel probe signal 4-20mA (0-100%RH) to clamps **20** and **21**; in particular, RH signal to clamp **20** and +V to clamp **21**. For further clarification on the channel probe, refer to chapter 3 on programming (variables StC, r0, t1).

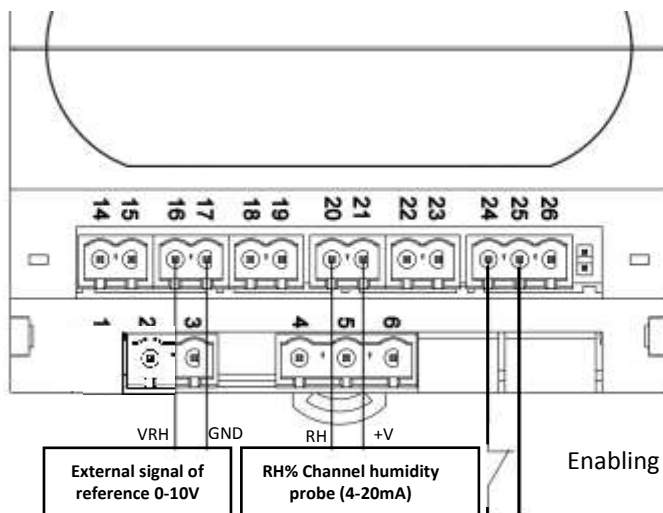

- **[S9=5] PROPORTIONAL functioning with 0-10Vdc ambient humidity probe (INTEGRATED HUMIDOSTAT):**

This type of functioning envisions proportional steam output; the humidifier will automatically regulate the steam output based on the request in ambient depending on set set. Consent is given by a 0-10Vdc (0-100%RH) humidity probe that, as well as regulate steam output, enables displaying relative humidity in ambient, directly on humidifier display. Set the second level variable **S9=5** and connect signal 0-10Vdc of the humidity probe to clamps **16** and **17**; in particular, connect VRH signal to clamp **16**, connect GND to clamp **17**.

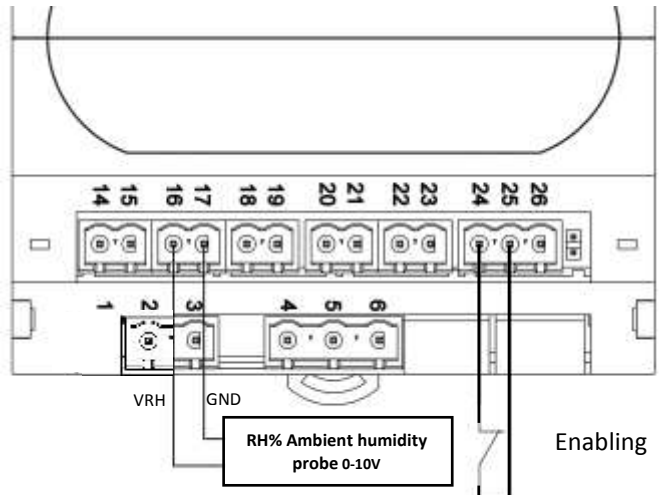
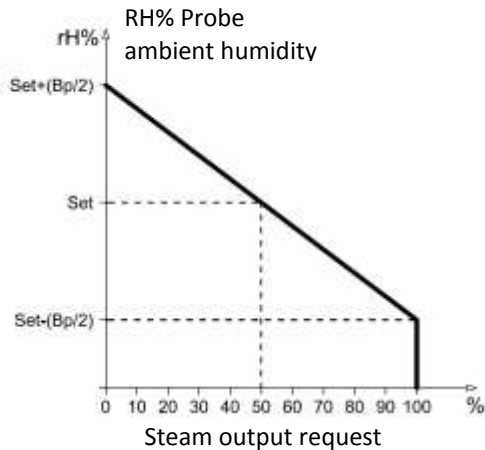

The Bp proportional band is the percentage value of the humidity around the set point; within this value the humidifier works proportionally. Example: if the proportional band is set on default value 10% ($\pm 5\%$ set point value) and humidity is set at 50%, below 45% the humidifier will work at 100% of steam output; above 55%, the humidifier will not produce steam. Between 45% and 55%, the humidifier will optimally regulate steam output.

- **[S9=6] PROPORTIONAL functioning with 0-10Vdc ambient humidity probe + 0-10Vdc limit channel probe (INTEGRATED HUMIDOSTAT):**

This type of functioning envisions proportional steam output; the humidifier will automatically regulate the steam output based on the request in ambient depending on set set and the value measured in duct.

Set the second level variable **S9=6** and connect signal 0-10Vdc of the humidity probe (0-100%RH) to clamps **16** and **17**; in particular, connect VRH signal to clamp **16** and connect GND to clamp **17**. Connect channel probe signal 0-10Vdc (0-100%RH) to clamps **22** and **23**; in particular, connect VRH signal to clamp **22** and GND to clamp **23**. For further clarification on the channel probe, refer to chapter 3 on programming (variables StC, r0, t1).

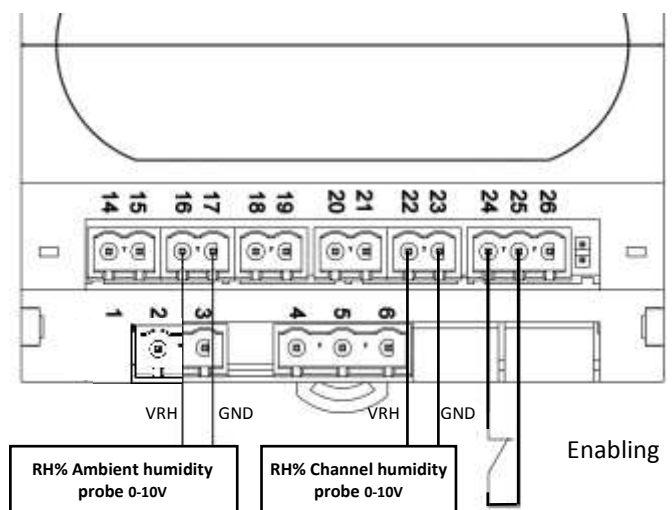

- **[S9=7] Functioning with integrated thermostat (ON/OFF hot call):**

This type of functioning envisions steam output in 2 ways only: no output or maximum output activated when temperature measured by the Ambient probe drops below the SET POINT-r1 value and remains active until the temperature increases and exceeds the SET POINT.

Set the second level variable **S9=7** and connect the NTC temperature probe to clamps **18** and **19** of the MasterHUM2 board.

(r1=Temperature differential referred to set point)

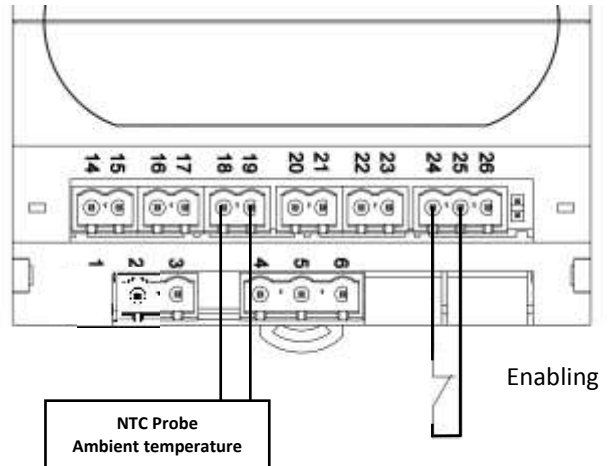
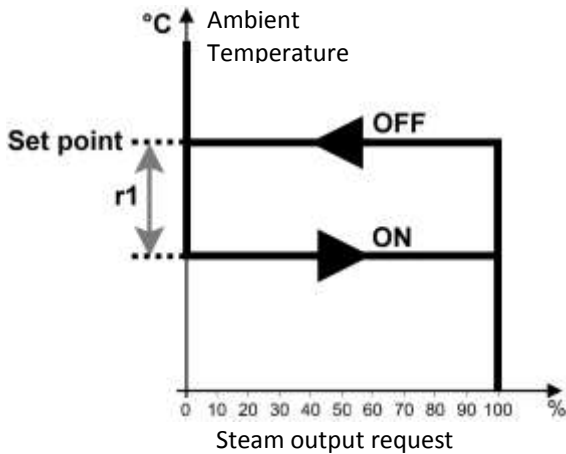

In this mode, it is possible to set the two configurable outputs (Do4 and Do5) to manage a few typical functions of a sauna or Turkish bath, like the supply of essence, the managing of inlet or outlet fans.

Essence Management (dO4 or dO5 = 4):

In a Turkish bath, the essence is supplied (with times set in t2 and t3), when the humidifier is in steam output and the temperature detected by the ambient probe is above 70% of the set point set. By means of the arrow up+Stand-by combination keys, it is possible at any moment to enable or disable the essence supply, in particular after having pressed the combination keys for three seconds, the current status is displayed (**EoF** = essence OFF or **Eon** = essence ON) and by keeping the keys pressed for a further three seconds, the status changes.

Inlet fan (dO4 or dO5 = 3):

The inlet fan is normally used to introduce or mix the steam in the room. The relay coupled with this function excites in presence of steam output request (it remains active also during the discharge phases for deconcentration or overcurrent). Alternatively, clamps 62 and 63 are present on the ES models, with a 230Vac voltage with steam output in progress (powered electrodes) and used for connection of the PEGO fan unit accessory.

Outlet fan (dO4 or dO5 = -3):

The outlet fan is normally used to guarantee air change and create fog effect. The relay coupled to this function excites when there is no steam output request. It is also possible to launch a drying cycle at the end of the day; with humidifier in stand-by, press the arrow down+Stand-by keys to activate the cycle, with the display signalling **Uon** = outlet fans ON. In this phase, only the outlet fan output remains active for the hours set in variable t4. To interrupt this cycle exit stand-by.

- **[S9=8] PROPORTIONAL functioning REFERRED TO VALUE SENT ON RS485 (0-100%):**

This type of functioning envisions steam output in proportion to value set in register 1537 by means of Modbus-RTU communication.

In this functioning mode the discharge forcing and steam output controls envision a 1 minute time-out; if during this period the control is not send back on Modbus, upon expiring of this time the steam output will be set at zero and the discharge pump will be disabled. This places the humidifier in safe conditions in case of accidental disconnections of the communication network.

Set the second level variable **S9=8** and connect the instrument to the RS485 line with clamp 32 to line A (TX+) and clamp 31 to line B (TX-).

For further information on Modbus-RTU Protocol of the humidifier, refer to document "MODBUS-RTU_UMIDMS03".

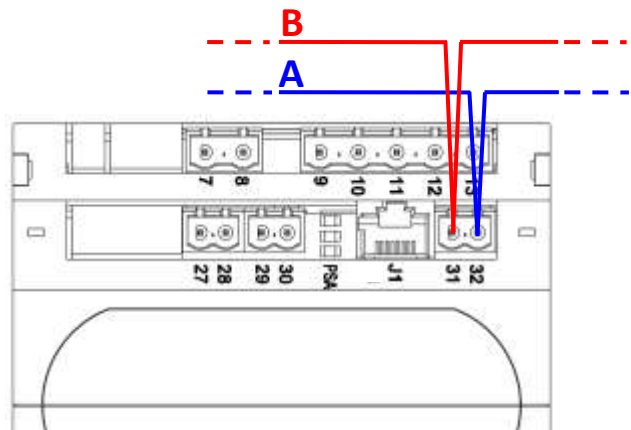

2.5

HUM2 BOARD DIGITAL INPUTS

Four digital inputs with the following meaning are present on the humidifier electronics:

Digital inputs In1, In2 in low voltage.

Input In1 (clamps 24 and 25): input with configurable meaning depending on second level variable In1. By default, this input is configured as "main enabling", active with close contact between clamps 24 and 25.

Input In2 (clamps 24 and 26): input with configurable meaning depending on second level variable In2. Input active with closed contact between clamps 24 and 26 or by means of jumper on board present at side of clamp 26. By default, this input is configured as "discharge pump activation" to enable discharging the cylinder in the absence of the console.

Digital inputs In3, In4 in high alternate voltage (mains voltage).

These inputs feel mains voltage and for them to function require connection of one of the two phases (in our case, neutral) to clamp 4.

Input In3 (clamps 4<neutral> and 6<phase>): input with configurable meaning depending on second level variable In3. Input active with input phase to clamp 6.

Input In4 (clamps 4<neutral> and 5<phase>): input of maximum water level in active cylinder with input phase to clamp 5.

In ES series humidifiers input In4 is pre-wired.

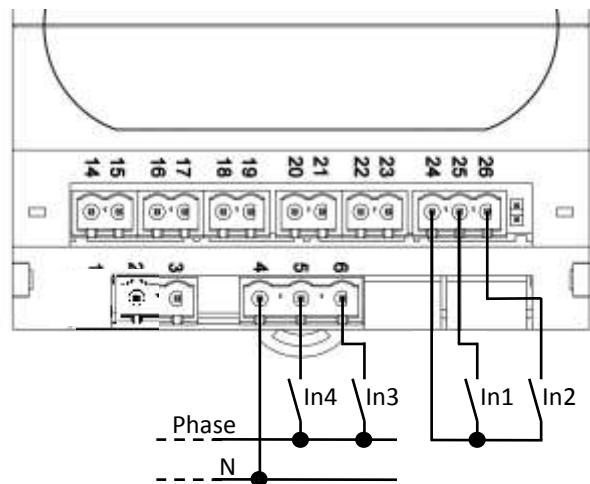

If none of the inputs In1, In2 and In3 is configured as enabling, the humidifier, for working, does not need an external enabling.

2.6

HUM2 BOARD DIGITAL OUTPUTS

Five relay are present on the humidifier electronics, two of which with configurable function: Digital outputs Do1, Do2, Do3 and Do5 are normally open contacts with a single common (clamp 9), whereas output Do4 is independent and electrically insulated, in particular:

Output Do1 (clamps 9 and 10): Electrodes.

Output Do2 (clamps 9 and 11): water charge EV.

Output Do3 (clamps 9 and 12): Discharge pump.

Output Do5 (clamps 9 and 13): Configurable relay.

Output Do4 (clamps 7 and 8): Configurable relay.

By default this output is set as alarm relay (second level variable dO4 = 1).

Relay capacity features:

Do1, Do2, Do3: 16(6)A 250Vac

Do4, Do5: 8(3)A 250Vac

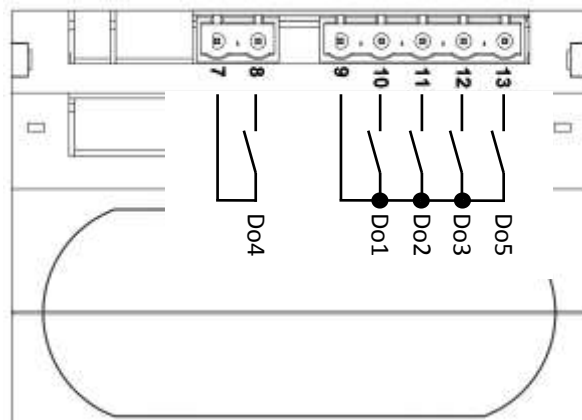

In the ES series, outputs Do1, Do2, Do3 are already wired.

2.7

TA INPUTS FOR MEASURING CURRENT ABSORPTION

Two inputs from amperometric transformer are present on the humidifier electronics to measure the current of the sunk-electrode:

TA1 (clamps 27 and 28): For connection of TA relating to cylinder N.1

TA2 (clamps 29 and 30): For connection of TA relating to cylinder N.2

2.8

BOARD POWER SUPPLY

The humidifier electronics requires a 230Vac 50/60Hz $\pm 10\%$ power supply and has a maximum consumption of 5VA (electronic part only).

Power supply (clamps 2 and 3): 230Vac 50/60Hz power supply.

2.9

NANO EASYSTEAM DISPLAY FOR MASTERHUM2 BOARD

The MasterHUM2 electronics is the core of the humidifier to which a NANO EasySTEAM display can be coupled, enabling the displaying of the machine status, the programming and configuration of the parameters. Connection between display and Master happens by means of a cable with 8-poles cross-connection RJ45 telephone connector (supplied with display) to be inserted in the two J1 references.

The coupled use of Master and display is the most complete and recommended method but not the only possible one; once configured, the MasterHUM2 electronics does not require the presence of display and can be used independently. It is also provided with status LED (see chapter 3.2) and switch (jumper) for the manual discharging of the cylinder (see chapter 2.5). In this single mode, the alarms are reset by disconnecting power supply to the board.

400ES100 Electrical layouts

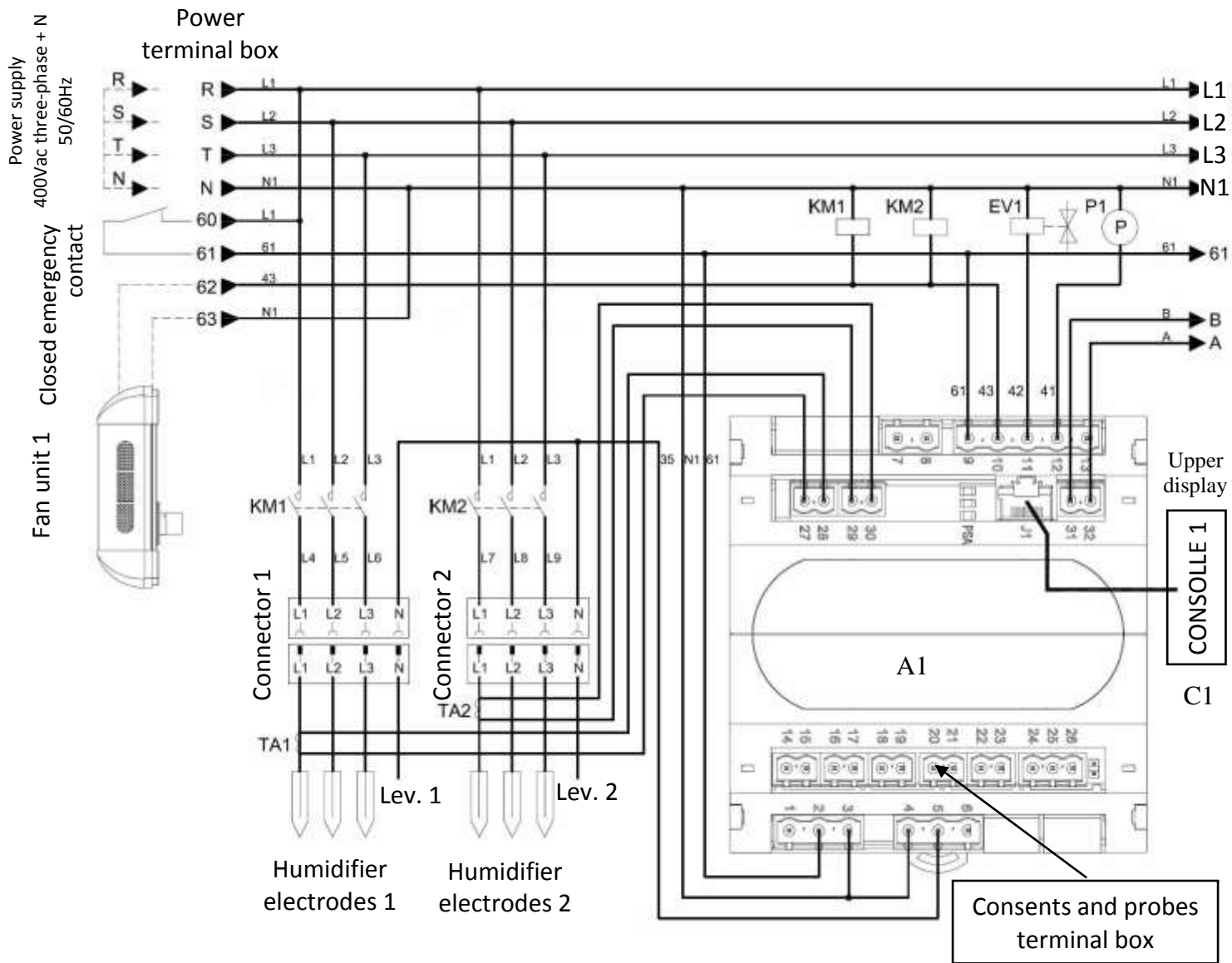

MASTER (Default)
 Setting: Ad=0 , MS=2

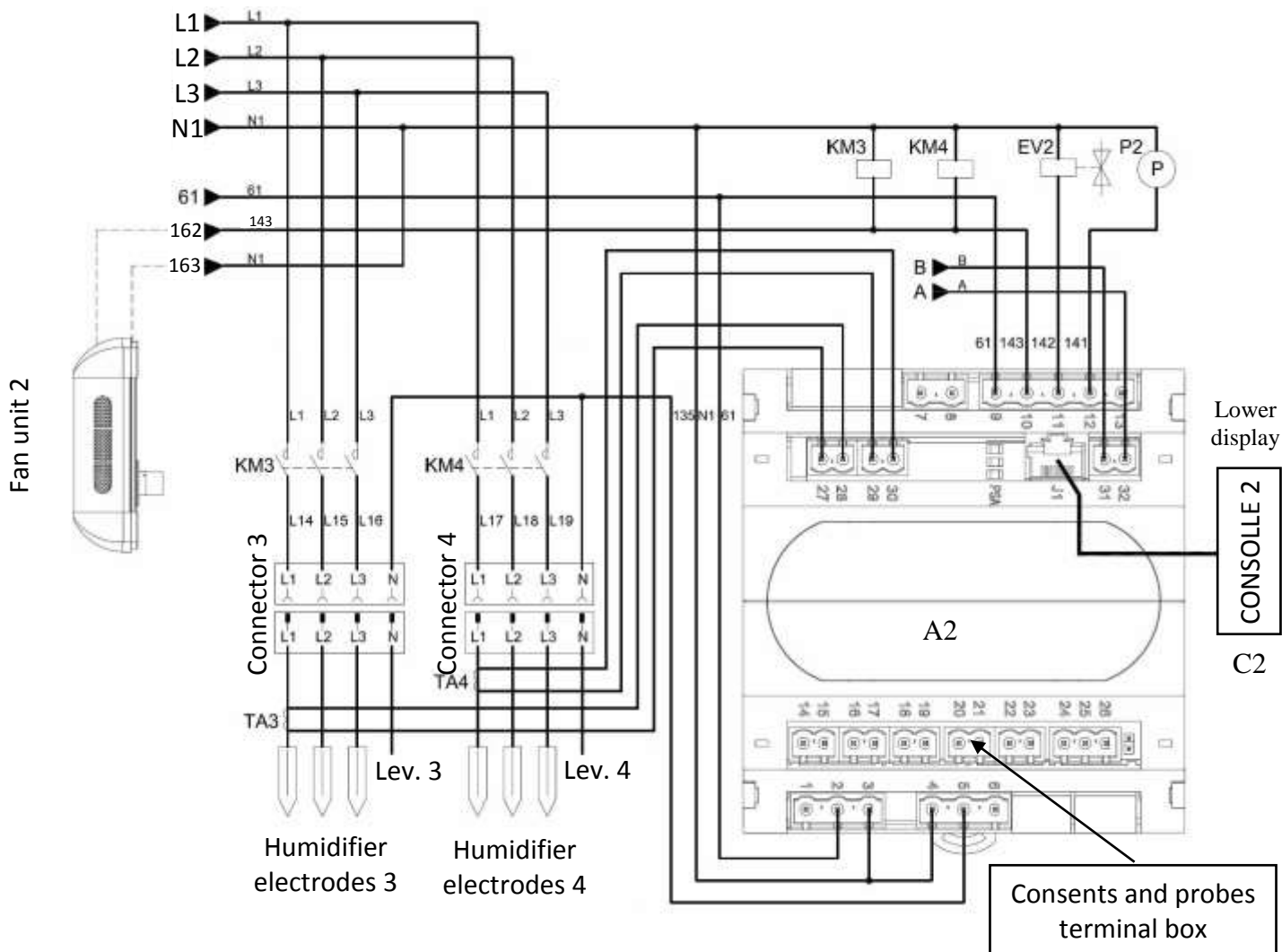

SLAVE (Default)
 Setting: Ad=1 , MS=1

CHAP. 3 PROGRAMMING

3.1

NANO EASYSTEAM DISPLAY DESCRIPTION

The NANO EasySTEAM display is normally found on the front of the humidifier. It is made of a 3-digit display and 9 luminous icons for visual control of the sizes and 4 keys for displaying choice and settings amendment (fig. 25).

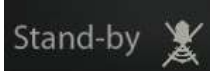



Fig. 25

UP / DISPLAY KEY

- 1**  - In programming: Increases values/Scrolls parameters upwards
- From main display: Selects display in: "absorbed current (A)", "steam output % (%)" and if S9 = 1 or 3 "Ambient humidity display (%RH)".
Every time it is pressed, it changes to successive display.

- 2**  **DOWN / MANUAL WATER DISCHARGE KEY**
- In programming: Decreases values/Scrolls parameters downwards
- From main display: Activates the water manual discharge

- 3**  **STAND BY / SILENCE**
- Pressed for more than 2 seconds alternates the Stand-by status to normal functioning status, and vice-versa. A confirmation beep is emitted upon occurred change-over.
- Silences the audio alarm if present / Acquires an alarm

- 4**  **SET (active with S9 = 1 or 3)**
- Displays set point when pressed and when released "Ambient humidity display (%RH)"
- Enables setting the %RH set point if pressed together with the Down or UP key
- Restores audio alarm, if present.

- 5**  **DISPLAY**

- 6**  **STAND-BY 4 ICON**
LED OFF = Humidifier not powered
LED ON = Humidifier ready for use
LED Flashing = Humidifier in stand-by

- 7**  **STEAM OUTPUT ICON**
LED ON = Steam output in progress

- 8



ALARM PRESENT ICON
LED OFF = No alarm present
LED ON = Maximum level alarm persistent for more than 1 hour
LED Flashing = Alarm present (or maximum level reached)
- 9



UNIT OF MEASURE IN TEMPERATURE ICON
LED ON = The display shows the temperature of the ambient probe °C
LED Flashing = The display shows the TEMPERATURE SET in °C
- 10



WATER CHARGE ICON
LED ON = Water charge in progress
- 11



WATER DISCHARGE ICON
LED ON = Water discharge in progress
LED Flashing = Water discharge test in progress
- 12



UNIT OF MEASURE IN CURRENT (A) ICON
LED ON = The display shows the instantaneous current absorbed in A by the humidifier.
- 13



UNIT OF MEASURE OF THE STEAM OUTPUT % ICON
LED ON = The display shows the steam output percentage referred to nominal one
 (Example: for an ES6 for 6kg/h steam output, 50% indicates the current output of 3kg/h.)
- 14



RELATIVE HUMIDITY UNIT OF MEASURE ICON.
 THIS ICON LIGHTS UP TOGETHER WITH (13) AND THE DISPLAY SHOWS "%HR"
LED ON = The display shows the relative humidity percentage of the connected probe
LED Flashing = The display shows the percentage relative humidity SET (visible and amendable by pressing the SET key)

3.2

COMBINATION OF KEYS

1ST LEVEL PROGRAMMING

If pressed simultaneously for more than 3 seconds they enable access to first level programming menu.

A confirmation BEEP is emitted upon access to menu.



EXIT FROM PROGRAMMING

If pressed simultaneously for more than 3 seconds within any programming menu, they save the settings made exiting the same menu.

A confirmation BEEP is emitted upon exit from menu.

2ND LEVEL PROGRAMMING

If pressed simultaneously for more than 3 seconds, they enable access to second level programming menu.

A confirmation BEEP is emitted upon access to menu.



ESSENCE SUPPLY STATUS CHANGE-OVER

(function active only if s9=7 and d04 or d05 = 3)

If pressed simultaneously for more than 3 seconds, the current status is displayed (EoF=essence OFF or Eon=essence ON) and by pressing them for a further three seconds, the status change-over is had.



DRYING ACTIVATION

(function active only if s9=7 and d04 or d05 = -3 and stand-by active)

If pressed simultaneously for more than 3 seconds the drying cycle is activated signalled by the writing on display Uon = outlet fans ON.

To interrupt this cycle exit stand-by.



3.3

STATUS LED ON MASTER HUM2 ELECTRONICS

Three signalling LED are present on board the Master HUM2 electronics at the side J1 connector that enable knowing the machine status, even without display.

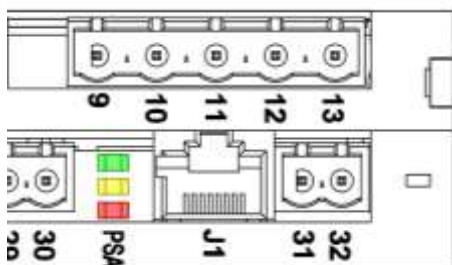
**GREEN LED** initialled P (Power):

Permanently on: power supply Ok and consent present

Flashing on: power supply Ok but no consent or stand-by present

YELLOW LED initialled S (Status):

Permanently on: Steam output (powered electrodes)

Flashing on: Discharge in progress. (0.5 seconds flashes)

RED LED initialled A (Alarm):

When present, an alarm generates a sequence of flashes every 0.5 seconds of a number equal to the error code and with a 2 seconds pause before restarting the sequence.

3.4

1ST LEVEL PROGRAMMING

1. The 1st level programming enables the user to amend 2 important parameters, the Bp proportional band and the Pr steam output percentage.

VAR.	MEANING	VALUES	DEFAULT ES100
Pr	Steam output percentage	20 ÷ 100 %	100 %
Bp	Proportional band (not used in ON/OFF version)	1 ÷ 20 Rh%	10 %
StC	Max humidity set point in channel. Upon exceeding of the set point, the humidifier positions itself at off and starts working when the humidity in channel drops below the StC - r0 value, with addition of t1 time, according to logic given by 0-10V signal or by the ambient humidity probe.	25 ÷ 99 Rh%	99%
r0	Max humidity set differential in channel.	1 ÷ (StC - 20) Rh%	50%
r1	Temperature differential referred to set point. For temperature values below set-r1, the humidifier activates until reaching of the set (called hot) (used only with S9= 7 version called hot)	0,2 - 10°C	2°C
UrC	Humidity value read by the channel probe	0-100%	read only



The Bp proportional band is the percentage value of the humidity around the set point; within this value the humidifier works proportionally. Example: if the proportional band is set on default value 10% ($\pm 5\%$ set point value) and humidity is set at 50%, below 45% the humidifier will work at 100% of steam output; above 55%, the humidifier will not produce steam. Between 45 and 55%, the humidifier will optimally regulate steam output.

The Pr steam percentage is the value the humidifier can reach at maximum output; leaving setting at 100%, an ES6 with 6kg/h steam output, can reach 6kg/h, if Pr setting is reduced to 50%, the humidifier can produce a maximum of 3kg/h.



The Pr variable is very useful in cases with scarce water conductivity and to make maximum use of the cylinder when near to being replaced; for further clarification, consult chapter 6 DIAGNOSTICS at page 36 of this manual.

The maximum humidity set point in channel (stC), limits humidity in channel.

If humidity in channel is higher than the value set in stC, the humidifier stops steam output and starts again when it drops below stC-r0 at the end of delay time t1 (second level variable).

2. To access the first level programming menu follow the instructions below:

- Simultaneously keep keys UP (\blacktriangle) and DOWN (\blacktriangledown) pressed until the first programming variable appears on the display.
- Release keys (\blacktriangle) and (\blacktriangledown)
- Select the variable to amend using key (\blacktriangle) or key (\blacktriangledown).
- After having selected the wanted variable it will be possible:
 - To display its setting by pressing the SET key
 - To amend the setting by keeping the SET key pressed and by pressing one of the (\blacktriangle) or (\blacktriangledown) keys.

To exit the menu once the configuration values are set, simultaneously keep keys (\blacktriangle) and (\blacktriangledown) pressed for a few seconds until the size displayed before entry to programming appears again, e.g. steam output or absorbed current. Memorisation of the amendments made to the variables will happen automatically when exiting the configuration menu.

3.5

2ND LEVEL PROGRAMMING

1. The 2nd level programming enables the user to amend different parameters advanced for a specific setting of the humidifier. It is not recommended to amend such parameters without indication from the PEGO after-sales assistance centre or a specialised technician.
2. To access second level programming, keep the UP (▲), DOWN (▼) and STANDBY keys pressed for a few seconds. When the first programming variable appears, the system automatically switches to stand-by.
 - Select the variable to amend using key (▲) or key (▼).
 - After having selected the wanted variable it will be possible:
 - To display its setting by pressing the SET key
 - To amend the setting by keeping the SET key pressed and by pressing one of the (▲) or (▼) keys.

To exit the menu once the configuration values are set, simultaneously keep keys (▲) and (▼) pressed for a few seconds until the cell humidity value appears again (displays 0.0 if ON/OFF).

Memorisation of the amendments made to the variables will happen automatically when exiting the configuration menu.

Upon exit from second level programming, press the ON/OFF - STAND-BY key to enable the electronic control. (when accessing 2nd level programming the humidifier automatically switches to STAND-BY mode).

VAR.	MEANING	VALUES	DEFAULT ES100
S0	Pump discharge duration time for deconcentration.	0.1 ÷ 12.7 s	5
S1	Hours of work	Tenths of hours	-
S2	Discharges for deconcentration interval. Interval in minutes of work (steam output) for deconcentration discharge. (S2 < 10 alarm E3 is deactivated)	1 ÷ 250 min	15
S3	Delay time in insertion of electrodes after any pump discharge. If increased, in particular installation situations, this parameter enables eliminating the differential intervention on the electric power supply line at the expense of the output rate of return after any discharge.	1 ÷ 12 s	2
S4	Water discharge after inactivity Full cylinder discharge for inactivity 0 = disabled	0 – 24 h	1
S5	Minimum current differential between one water charge and successive.	0.2 ÷ 10 A	4
S6	Overcurrent percentage referred to work current for discharge pump activation	1 ÷ 50 %	20
S7	Pump discharge duration time for overcurrent.	0.1 ÷ 5.0 s	0.5
S8	Minimum current differential for water charge during full or partial cylinder charging. S8=0.0 sets charging at Step.	0.0 ÷ 5.0 A	0.5

S9	<p>Functioning setting set:</p> <p>S9=0 ON-OFF (Enabling ON between clamps 24 and 25)</p> <p>S9=1 (INTEGRATED HUMIDOSTAT) PROPORTIONAL WITH 4-20mA PROBE. Functioning with integrated humidostat. Ambient humidity probe 4-20mA connected to analogical input n.1 (clamps 14-15).</p> <p>S9=2 PROPORTIONAL REFERRED TO 0-10V EXTERNAL SIGNAL Signal of reference 0-10V connected to analogical input n.2 (clamps 16-17).</p> <p>S9=3 (INTEGRATED HUMIDOSTAT) PROPORTIONAL WITH 4-20mA PROBE AND MAXIMUM LIMIT IN CHANNEL 4-20mA PROBE. Ambient humidity probe 4-20mA connected to analogical input n.1 (clamps 14-15). Maximum limit in channel 4-20mA probe connected to analogical input n.4 (clamps 21-22).</p> <p>S9=4 PROPORTIONAL REFERRED TO 0-10V SIGNAL AND MAXIMUM LIMIT IN CHANNEL 4-20mA PROBE. Signal of reference 0-10V connected to analogical input n.2 (clamps 16-17). Maximum limit in channel 4-20mA probe connected to analogical input n.4 (clamps 21-22).</p> <p>S9=5 (INTEGRATED HUMIDOSTAT) PROPORTIONAL WITH 0-10V PROBE Ambient humidity probe 0-10V connected to analogical input n.2 (clamps 16-17).</p> <p>S9=6 (INTEGRATED HUMIDOSTAT) PROPORTIONAL WITH 0-10V PROBE AND MAXIMUM LIMIT IN CHANNEL 0- 10V PROBE. Ambient humidity probe 0-10V connected to analogical input n.2 (clamps 16-17). Maximum limit in channel 0-10V probe connected to analogical input n.5 (clamps 22-23).</p> <p>S9=7 (INTEGRATED THERMOSTAT) Functioning with integrated thermostat (hot call ON/OFF) and NTC temperature probe connected to analogical input n.3 (clamps 18-19).</p> <p>S9=8 PROPORTIONAL REFERRED TO VALUE SENT ON RS485 (0-100%) Steam output request reference (0-100%) from RS485 line (Modbus). To set steam output, use register 1537 . N.B. – The steam output and discharge force controls envision a 1 minute time-out; if, during this period, the control is not sent again, upon expiring of this time, steam output will be placed at zero and the discharge pump will be disabled. This places the humidifier in safe conditions in case of accidental disconnections of the network.</p> <p>Attention: enabling between clamps 24 and 25 must be given for any chosen type of functioning.</p>	0 ÷ 8	0
	<p>S10 Discharge Test 0 = Disabled 1 = Enabled</p>	0 ÷ 1	1
	<p>CA1 Humidity probe calibration (used when S9 = 1, 3, 5, 6)</p>	-20 % ÷ 20 %	0 %
	<p>CA2 Channel humidity probe calibration (used when S9 = 3, 4, 6)</p>	-20 % ÷ 20 %	0 %

CA3	NTC probe value correction (used when S9=7)	-10,0 ÷ 10,0 °C	0,0
t1	Delay in seconds to humidifier re-start. Delay starts from when after the exceeding of StC by the humidity in channel, it drops below StC-r0 again. Only after this delay will normal functioning start again. (used when S9 = 3, 4, 6)	0-240 s	10 s
t2	Functioning time ON for essence. If steam output is present and temperature is above 70% of SET set, the relay configured for essence call does so for the t2 time and awaits the t3 time between one call and another. (used only when S9=7)	1-30 s	2 s
t3	Functioning time OFF for essence. If steam output is present and temperature is above 70% of SET set, the relay configured for essence call does so for the t2 time and awaits the t3 time between one call and another. Con t3=0 continuous essence call is had if the above conditions are satisfied. (used only when S9=7)	0-99 min	5 min
t4	Timer for manual insertion outlet fans. Manually activated function with down arrow + Stand-by combination keys and active only with S9=7, dO4 or dO5 = -3 and humidifier in stand-by. Once the plant is placed in stand-by at the end of the day, there is the possibility of functioning the outlet fans for a certain time to dry the room.	0-24 ore 0 = Disabled	0
t5	Activation time E9 serious Alarm . If the E8 alarm continues for a time longer than t5, starts the E9 serious alarm. E9 serious alarm starts also if in the space of 12 hours occur 3 alarm E8 situations. E9 alarm is disabled with t5=0.	0-99 min 0 = Disabled	15 min
In1	Digital input In1 and activation status setting. ±10 = drain pump driving ±9 = functioning reduced to 90% ±8 = functioning reduced to 80% ±7 = functioning reduced to 70% ±6 = functioning reduced to 60% ±5 = functioning reduced to 50% ±4 = functioning reduced to 40% ±3 = functioning reduced to 30% ±2 = Enabling (in series with eventual In2 and In3 enabling) ±1 = alarm input 0 = disabling “+” for active input with close contact “-“ for active input with open contact	-10 ÷ 10	2
In2	Digital input In2 and activation status setting. See In1 options	-10 ÷ 10	10
In3	POWERED input In3 and activation status setting. See In1 options	-10 ÷ 10	0

dO4	<p>Digital output dO4 functioning setting. The less sign indicates the reverse status of the relay. With the exception of settings 1, -1, 2, -2, the relay is deexcited in case of no enabling or it is in stand-by. 4 = Relay excited for essence call 3 = Inlet fan relay (excited with steam output request) 2 = Relay excited with plant in stand-by or no consent. 1 = Relay excited in presence of alarm 0 = Relay Disabled -1 = Relay de-excited in presence of alarm -2 = Relay de-excited with plant in stand-by or no consent. -3 = Outlet fan relay (de-excited with steam output request)</p>	-3 ÷ 4	1
dO5	<p>Digital output dO5 functioning setting. The less sign indicates the reverse status of the relay. With the exception of settings 1, -1, 2, -2, the relay is deexcited in case of no enabling or it is in stand-by. 4 = Relay excited for essence call 3 = Inlet fan relay (excited with steam output request) 2 = Relay excited with plant in stand-by or no consent. 1 = Relay excited in presence of alarm 0 = Relay Disabled -1 = Relay de-excited in presence of alarm -2 = Relay de-excited with plant in stand-by or no consent. -3 = Outlet fan relay (de-excited with steam output request)</p>	-3 ÷ 4	0
HSE	Maximum value attributable to set point	0 ÷ 99	99
Ad	Network address for connection to supervisor system MODBUS-RTU or master-slave configuration.	0 ÷ 247	Master (A1) Ad=0 Slave (A2) Ad=1
MS	<p>Master-Slave type of functioning setting. (with MS=0 modbus is enabled) 0 = Single 4= Master + 3 slave 1 = Slave 5= Master + 4 slave 2 = Master + 1 slave 6= Master + 5 slave 3 = Master + 2 slave</p>	0 ÷ 6	Master (A1) MS=2 Slave (A2) MS=1
rEL	release software MASTER	read only	13

CHAP. 4 HUMIDIFIER MASTER/SLAVE

4.1

SINGLE HUMIDIFIER CONFIGURATION

The humidifier EasySTEAM ES100 is configured by default to MASTER/SLAVE because inside there are two electronic modules that manage each one half humidifier, if you configure the two electronic devices such as "single" is like having two independent 48kg/h humidifiers, therefore also the inputs and outputs will be independent.

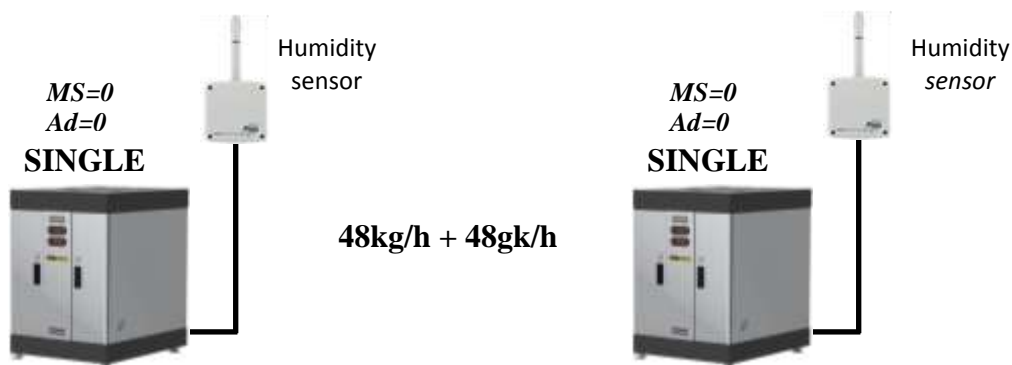

4.2

MASTER/SLAVE HUMIDIFIERS CONFIGURATION (default configuration)

This configuration is used by default because it permits to the 2 electronic modules to manage at the same time the four cylinders which stand inside the humidifier.

It is also possible to rely different devices: in this case, humidifiers (up to a maximum of 3 units) behave as if they were a unique machine, by generating steam referring to the common reference given by the Master unit.

The Master also manages the priority deconcentration or test discharges of the various humidifiers (including its own), with FIFO (one deconcentration discharge at a time), guaranteeing continuity in steam output.

Connections between master and slave:

The humidifier configured as master, communicates with the various slave humidifiers by means of an RS-485 serial connection between the various Master HUM2 electronics.

Maximum connection length is not defined but depends on the quality of the cable and the signal/disturbance ratio. It is indicatively fixed at 500 meters.

The connection cable can be non-shielded if the distance is of a few meters in an electrically slightly "noisy" ambient. For distances between 15 and 100 meters, it is possible to use a shielded and twisted cable without particular features, whereas for connections over 100 meters it is, for example, advised to use **BELDEN 8762** cable.

The communication line must be of chain type, avoiding star configurations.

The shield of the used cable must be ground connected on one side. Avoid housing the RS-485 serial connection in the same ducts (or tubes) of the power or power supply cables.

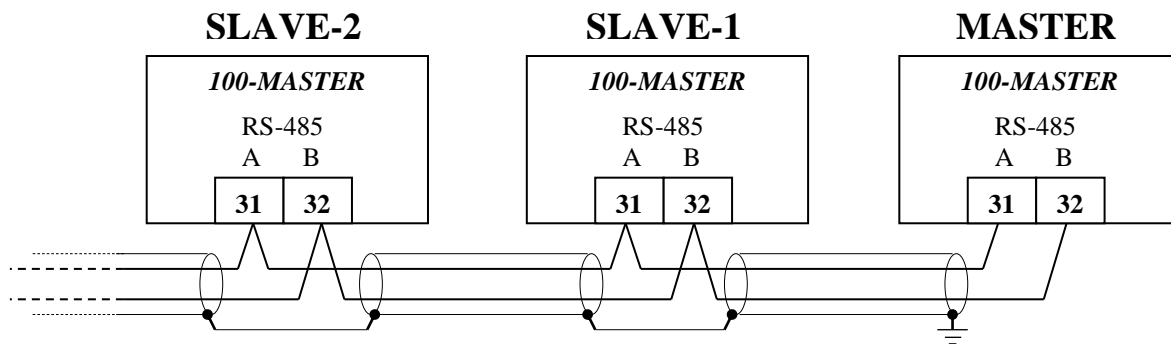

Master/Slave address:

Setting of parameters **MS** and **Ad** of the various units in this configuration, is permanent and follows the rule below:

Parameters configuration in Master unit:

- Ad = 0 Control Master Address (unit 1, default)
- MS= 2 With Control Master + slave1 (unit 1, default)
- 3 With Control Master + slave1+ slave2 (unit 2)
- 4 With Control Master + slave1+ slave2+ slave3 (unit 2)
- 5 With Control Master + slave1+ slave2+ slave3+ slave4 (unit 3)
- 6 With Control Master + slave1+ slave2+ slave3+ slave4+ slave5 (unit 3)

Parameters configuration in slave1 unit (unit 1, default):

- Ad = 1 (Ad Master +1)
- MS= 1 slave

Parameters configuration in slave2 unit (unit 2):

- Ad = 2 (Ad Master +2)
- MS= 1 slave

Parameters configuration in slave3 unit (unit 2):

- Ad = 3 (Ad Master +3)
- MS= 1 slave

Parameters configuration in slave4 unit (unit 3):

- Ad = 4 (Ad Master +4)
- MS= 1 slave

Parameters configuration in slave5 unit (unit 3):

- Ad = 5 (Ad Master +5)
- MS= 1 slave

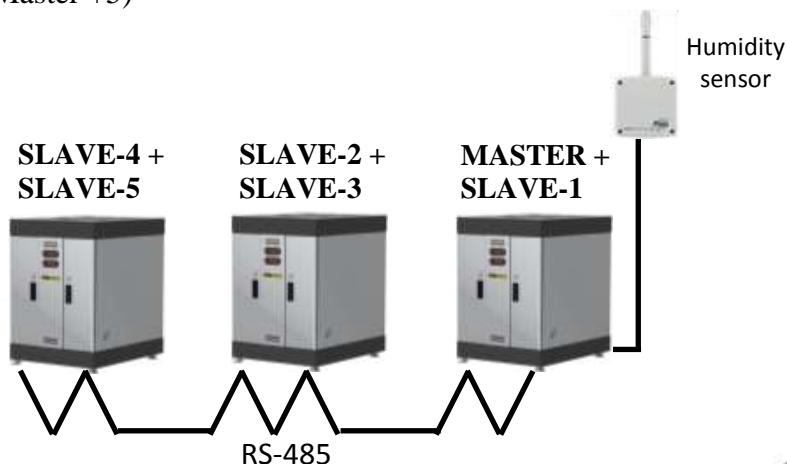

Functioning description:

The unit configured as Master constantly communicates with the slave connected by means of 485, sending them data of the steam to be produced (0-100%) and managing the priorities of the various units relating to discharges for deconcentration or test.

The functioning mode of the Master/Slave unit set is set only on Master by means of variable S9, as well as the eventual connection of the ambient humidity probe, of the channel humidity probe, of the signal of reference 0-10V, the ON-OFF enabling and the setting of the wanted humidity set.

Whereas, the Pr variable representing the steam output percentage at maximum output, is set on each individual unit.

The lacking of enabling (clamps 24 and 25 open on 100Master board) behaves as follows:

- On Master unit, stops (OFF flashing) the same unit and all slave units connected.
- On Slave units, stops (OFF flashing) only slave unit of interest.

The insertion of the stand-by, by means of dedicated key, behaves as follows:

- If activated on Master unit, places machine in stand-by (LED on stand-by button flashing) and bring the steam output request of the connected slave to zero.
- On Slave units, stops only the slave unit of interest, placing the machine in stand-by (LED on stand-by button flashing).

Should Master not find a slave, after a 15 sec timeout, it signals the problem with an alarm message that can be switched off (E7). Such alarm does not block normal functioning. Slave interrogation continues and if communication starts again, the error is automatically reset.

If Slave is not interrogated by Master within a 15 sec timeout, Slave considers connection with the same interrupted and brings steam output to 0, disconnecting the electrodes and signalling the anomaly with an alarm that can be switched off (E8). Should connection start again, the error is automatically reset and normal functioning starts again.

Variable S9 on humidifiers configures as Slave (mS=1) is not taken into consideration; steam output proportionally follows data sent by Master on RS485.

Test and deconcentration discharge priority management:

The priorities of discharge for deconcentration and for diagnostic test, are managed as follows:

When interrogated, the Slave units send eventual discharge request to Master that manages them with FIFO (first input/first output).

Master awaits 3 minutes before giving successive consent to unit in stand-by, following priority in FIFO; this allows the unit currently in discharge, to start steam output again.

The Slave unit having requested a discharge, awaits 45 minutes for consent from Master, after which discharged is performed anyhow (Time out).

CHAP. 5 HUMIDIFIER IGNITION**5.1****COMMISSIONING**

1. Check default setting is compatible with connection of performed signal; if different, correctly configure electronics before powering, as described in chapter 2.

2. Before powering the humidifier, check correct connection of the phases and type of input signals; check correct connection of mains water, excess water discharge and steam tube.



If the mains water connection line has been made with piping that may contain oily residues or other substances generating foam, it is essential to wash the same leaving water to run for a few minutes.

3. Check for water leaks inside the humidifier.
4. Power the humidifier.
5. The humidifier will perform water discharge for a few second emitting a prolonged beep.
6. Humidifier is now in STAND-BY mode; to switch-on press ON/OFF – STAND-BY key, the humidifier will display the humidity value measured by the probe for models configured with PROPORTIONAL 4-20mA mode, or current absorption for those configured in ON/OFF and PROPORTIONAL 0-10V mode.
7. For the humidifier to work it requires enabling to digital input 1 by means of a potential free contact (clamps 24 and 25 on the MasterHUM2 microprocessor board), regardless of the selected functioning mode. Without enabling, the display alternates the OFF writing with normal displaying.

5.2**STEAM OUTPUT**

1. Set the wanted humidity value by pressing the SET key and increasing value using the UP key in PROPORTIONAL 4-20mA models (if set value is above that recorded by the probe, steam output starts); or given ON/OFF or 0-10V consent in ON/OFF or PROPORTIONAL 0-10V models.

2. Leave the cylinder to be filled until water starts boiling, completely drain the cylinder with the MANUAL DISCHARGE key, to trigger the pump and repeat operation 1-2 times.
3. The humidifier is now operational and can correctly and autonomously function.

CHAP. 6 DIAGNOSTICS

In case of anomalies, the EASYSTEAM humidifier warns the operator by means of alarm codes, visual and acoustic signalling.

Upon verifying of an alarm condition, the display icon switches on, the alarm relay is activated (if configured), the internal buzzer is activated and one of the following alarm codes is displayed.



The internal buzzer can be inhibited at any moment by pressing the "Silence" key. Pressing the SET key once restores sound signalling.

There are three types of alarms, depending on their seriousness:

- Automatic reset (the alarm is automatically reset upon disappearing of the problem)
- Manual reset from keyboard (alarm is automatically reset)
- Manual reset by disconnecting the board (serious alarm cannot be silenced)

Without console, it is possible to identify the type of alarm present by counting the flashes of the red LED on board the Master (e.g. E3 there are 3 flashes followed by a long pause. Whereas, alarm E0 is signalled by the permanent switch-on of the red LED on Master).

To reset an alarm without automatic reset in display absence, disconnect the electronics. By default, output Do4 (clamps 7 and 8) is set as alarm relay (second level variable dO4 = 1).

CODE	POSSIBLE CAUSE/DESCRIPTION	OPERATION TO BE PERFORMED	RESET
OFF flashing	No enabling consent	Check enabling consent to clamps 24 and 25 on Master HUM2 and configuration of eventual additional consents of the digital inputs	automatic
 flashing without any alarm code	Maximum water level inside cylinder The water inside the cylinder has reached the maximum level sensor and absorbed current is within admitted range (> 0.5A). (sound signalling is not had during this alarm) If the water inside the cylinder reaches maximum level sensor at the beginning of a steam output cycle, the cylinder completely discharges to attempt eliminating the foam present (anti-foam cycle) and steam output starts again. If the level is still reached after the anti-foam cycle, the water charge blocks and steam output continues.	Suspended particles produced by oils or greases present in the charge line can cause the forming of foam that activates the level. Completely wash the cylinder a few times by means of manual discharge immediately after complete charge. Water conductivity above 1300µS/cm can cause the forming of foam. Increase frequency of deconcentration discharges by acting on parameter S2. Verify there is no water underneath the cable-carrier circular tube, on the upper part of the cylinder. If present, this can penetrate the circular tube and create a false contact on level. Carefully dry everything.	automatic
 permanent without any alarm code	Stay of maximum water level inside cylinder The maximum water level inside cylinder sensor has been continuously activated for more than one hour after an anti-foam cycle. This alarm blocks steam output until its acquisition (pressing of Silence key).	Use the same arrangement as for the "Maximum water level inside cylinder".	manual
En	No connection between NANO EasySTEAM display and Master HUM2 electronics	Check connection on J1 connector and of connection cable.	automatic
E0	Functioning anomaly of the ambient probe set in variable S9.	Check correct configuration of used probe (variable S9 and electric connections on specific clamps). If problem persists, replace the probe.	automatic

<p>E1</p>	<p>Maximum water level inside cylinder/Current reading problems.</p> <p>The water inside the cylinder has reached the maximum level sensor and absorbed current is below minimum threshold of 0.5A.</p> <p>Reaching of the maximum level combined with measured current too low, identifies an anomaly that should not occur in normal functioning.</p> <p>This alarm blocks steam output until its acquisition (pressing of Silence key).</p>	<p>Check correct insertion of the cylinder connector to humidifier.</p> <p>Using an ammeter clamp, check absorption on the power supply phases; one may be interrupted.</p> <p>Check wear of the cylinder electrodes.</p> <p>Check water conductivity is above minimum admitted for the type of cylinder used; in particular, for normal cylinders greater than 250µS/cm and for low conductivity cylinders greater than 125µS/cm. In case, try reducing the steam output % by acting on the Pr variable to lower the working level of the water inside the cylinder.</p> <p>Suspended particles produced by oils or greases present in the charge line can cause the forming of foam that activates the level. Completely wash the cylinder a few times by means of manual discharge immediately after complete charge.</p> <p>Water conductivity above 1300µS/cm can cause the forming of foam. Increase frequency of deconcentration discharges by acting on parameter S2.</p> <p>Verify there is no water underneath the cable-carrier circular tube, on the upper part of the cylinder. If present, this can penetrate the circular tube and create a false contact on level. Carefully dry everything.</p>	<p>manual</p>
<p>E1 +</p>  <p>flashing</p>	<p>Anomaly on pump discharge test (Missed 5 consecutive tests).</p> <p>If the maximum level is touched during a pump discharge test (one every 10 hours of functioning) or current test It is not reached within 10 minutes, the test is abandoned, considering it MISSED. After having missed 5 consecutive tests, error E1 is launched and the steam output blocked until acquisition of the alarm (pressing of Silence key).</p>	<p>Use the same arrangements taken for the above described error E1.</p>	<p>manual</p>
<p>E2</p>	<p>Functioning anomaly of the channel probe set in variable S9.</p>	<p>Check correct configuration of used probe (variable S9 and electric connections on specific clamps). If problem persists, replace the probe.</p>	<p>automatic</p>
<p>E3</p>	<p>No water for a prolonged time.</p> <p>S2 >= 10 and water charge outlet remains active for a time equal to (S2 less 1 minute), alarm E3 triggers. If S2 < 10 alarm E3 is deactivated.</p> <p>This alarm blocks steam output. To reset the alarm, access and exit stand-by.</p>	<p>Check the mains water line is active.</p> <p>Verify there is no water leaking due to breaking.</p> <p>Verify the water charge valve is not faulty or disconnected.</p>	<p>manual</p>

<p>E5</p>	<p>Failed discharge control auto-test (Pre-alarm) This alarm does not block steam output; the cause of the problem must be eliminated prior to successive test performed every 10 hours of functioning of the electrodes to avoid occurring of the blocking error E6. Alarm is automatically reset upon successive discharge test if it passes or upon humidifier switch-off.</p>	<p>Check the discharge or bottom of the cylinder are not obstructed and the pump is not faulty or disconnected. In case pump test I1 is not considered necessary, it can be disabled by bringing variable S10=0</p>	<p>automatic</p>
<p>E6</p>	<p>Discharge control auto-test failed for second consecutive time. This alarm blocks steam output to avoid damaging the unit and cannot be silenced. To reset the alarm switch-off humidifier.</p>	<p>Check the discharge or bottom of the cylinder are not obstructed and the pump is not faulty or disconnected. In case pump test I1 is not considered necessary, it can be disabled by bringing variable S10=0</p>	<p>manual</p>
<p>E7</p>	<p>In a Master/Slave humidifiers configuration, the Master unit cannot find a slave connected to it. Such alarm does not block normal functioning and, upon connection restore, the alarm is automatically reset.</p>	<p>Check connections between master unit and slave unit. Check second level MS and Ad parameters relating to Master/Slave configuration.</p>	<p>automatic</p>
	<p>In a Master/Slave humidifiers configuration, the unit has lost communication. Such alarm blocks the unit but, upon connection restore, the alarm is automatically reset.</p>	<p>Check connections between master unit and slave unit. Check second level MS and Ad parameters relating to Master/Slave configuration.</p>	<p>automatic</p>
<p>E8</p>	<p>Alarm from digital input (usually safety thermostat). This alarm starts if one of digital inputs configured as alarm persists for more than 5 seconds. It blocks the steam production and activates the acoustic signalling (can be switched off). The alarm is automatically reset when the alarm input disappears.</p>	<p>Check the alarm input (usually safety thermostat)</p>	<p>automatic</p>
<p>E9</p>	<p>SERIOUS alarm from digital input (usually safety thermostat). If the E8 alarm persists continuously for a time longer than t5, starts the E9 serious alarm. The E9 alarm starts also if in the space of 12 hours occur 3 alarm E8 situations. It blocks the steam production to avoid the damage of the unit and it cannot be switched off. The E9 alarm is disabled with t5=0. To reset the alarm, the humidifier has to be switched off.</p>	<p>Check the alarm input (usually safety thermostat)</p>	<p>manual</p>
	<p>Differential protection upstream of the power supply line of the humidifier intervenes. Water present in lower part of humidifier due to a fault or after maintenance causing unit dispersion towards the ground.</p>	<p>Bring unit in safe conditions following instructions in chapter 7.2. Carefully dry all wet parts and activate the unit again.</p>	
	<p>Humidifier produces insufficient steam.</p>	<p>One of the phases may be interrupted. Check current absorption on all phases. Check the steam tube is not obstructed by water stored in a lock of the tube. The tube must not create siphons (see chapter 8)</p>	

CHAP. 7 MAINTENANCE

7.1

MAINTENANCE

To guarantee operational safety, correct functioning and optimal yield of the EASYSTEAM series humidifiers, carry out routine maintenance interventions as reported below.

7.2

GENERAL AND SAFETY STANDARDS



Whatever the nature of the maintenance, it must only be carried out by experienced and qualified technical personnel, aware of the necessary safety precautions.

Before starting any maintenance operation, proceed as follows:

1. If unit is out of service due to an alarm condition, take note of the error code on the display.
2. Close the shut-off valve of the water supply line.
3. Bring the humidifier in stand-by acting on appropriate key and completely drain the water inside the cylinder by pressing the manual discharge button on front of NANO display (see chapter 3).
4. Disconnect the unit from the electric mains by permanently isolating the upstream power supply switch, padlocking it on OFF.
5. Wait for the cylinder and the humidifier to have cooled down or use protective gloves.
6. Every element of the unit, if faulty, must be replaced only with original parts.

7.3

MAINTENANCE INTERVALS

Reported below are the maintenance operations to be carried out and their recommended frequency. As the electrodes consumption and the forming of solid scaling and deposit inside the cylinder vary depending on the type of water (even with equal conductivity), such intervals may need to be amended.

Verify this requirement by checking the amount of deposit inside the cylinder; a quick storing of scaling and deposits requires increasing the recommended maintenance frequency and/or varying the parameters relating to the deconcentration discharges.



To reduce the forming of deposits at bottom of cylinder, it is advised to increase frequency of deconcentration discharges, reducing the value of variable **S2**. However, this arrangement has the disadvantage of greater water and energy consumption.

INTERVENTION TO BE PERFORMED	FREQUENCY
Check for water leaks inside the humidifier.	After 1 hour of functioning
Check fastening of electric connections.	After 4 weeks of functioning
Check for water leaks inside the humidifier. Check cylinder status; eliminate any scaling and deposits from inside, if present. If necessary, replace cylinder.	Monthly or every 500 hours of functioning
Check cylinder electrodes consumption and absence of deformations or blackening on their surface; replace cylinder if worn and having evident defects.	Three-monthly or every 1000 hours of functioning
Replace cylinder. Check fastening of the electric connections and good status of the water and steam connections.	Yearly or every 2500 hours of functioning
Check for water leaks inside the humidifier. Check cylinder status; check wear of the electrodes and eliminate any scaling and deposits from inside, if present and, if necessary, replace cylinder.	Upon occurring of alarm code E1
Check for water leaks inside the humidifier. Verify the water charge valve is not disconnected or faulty, if so replace it.	Upon occurring of alarm code E3
Check the discharge pump is not disconnected or faulty and, if so, replace it. If present, remove any clogging from bottom of cylinder and inside discharge tubes.	Upon occurring of alarm code E5 or E6

7.4

REPLACING THE CYLINDER



The only consumption element of the humidifier is the cylinder when the electrodes are worn due to machine functioning or they cannot eliminate the scaling formed within.

The EASYSTEAM series is provided with stainless steel electrodes for longer duration that, however, depends on the amount of water (level of conductivity and hardness) and work output to which the humidifier is submitted.

When the electrodes are worn making cylinder replacement necessary, the water level rises anomalously compared to optimal functioning, repeatedly triggering the maximum level alarm **E1**.

Now having checked the alarm is not caused by other anomalies (see chapter 6 Diagnostics), carry out replacement as indicated below:



NEVER REPLACE THE CYLINDER WITH MACHINE HOT AND WITH WATER INSIDE. BEFORE CARRYING OUT THE OPERATION, COMPLETELY DISCHARGE THE CYLINDER USING THE MANUAL DISCHARGE KEY! IT IS COMPULSORY TO FOLLOW THE PRESCRIPTIONS INDICATED IN CHAPTER 7.2

1. Open the humidifier extracting the front cover as indicated in chapter 2.2.
2. Release the front fixing spring of the upper steam flange making it slide outside the cylinder (Fig. 27 and 28).



Fig. 27



Fig. 28

3. Release the rear fixing spring of the upper steam flange making it slide outside the cylinder (Fig.30).



Fig. 30

4. Lift the upper steam flange releasing it from the cylinder (fig. 31).



Fig. 31

5. Remove the electric connection connector of the cylinder (fig. 32)

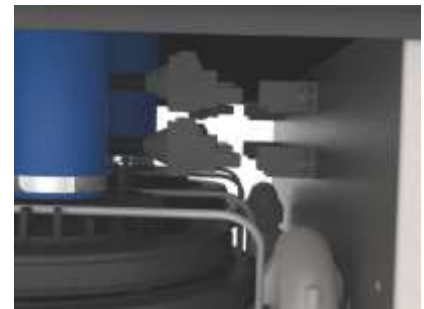

Fig. 32

6. Remove the cylinder from the lower flange extracting it upwards (fig. 33) and remove it from the humidifier (fig. 34).



Fig. 33



Fig. 34

7. Insert the new cylinder repeating the removal operations in reverse order, checking that the new cartridge is provided with two O-rings and that they are correctly positioned. Use the lubricant provided with the humidifier to lubricate the O-ring and the flanges to facilitate insertion. (fig. 35 e 36).



Fig. 35



Fig. 36

8. Completely wash the cylinder two or three times after replacement, using the "manual discharge" key.
9. After one hour of functioning from cylinder replacement, check there are no water leaks inside the humidifier.

7.5

CLEANING THE CYLINDER



When scaling and deposit inside the cylinder prevent sufficient current passage between electrodes or obstructs water discharge, clean the cylinder.



NEVER EXTRACT THE CYLINDER WITH MACHINE HOT AND WITH WATER INSIDE. BEFORE CARRYING OUT THE OPERATION, COMPLETELY DISCHARGE THE CYLINDER USING THE MANUAL DISCHARGE KEY! IT IS COMPULSORY TO FOLLOW THE PRESCRIPTIONS INDICATED IN CHAPTER 7.2

1. Extract the cylinder from the humidifier by following steps 1-6 described in chapter 7.4
2. Using the hole in the upper part of the cylinder, clean and eliminate scaling present on the electrodes and on the accessible parts by means of mechanical action using a plastic spatula and running water or a water and acetic acid at 20% (Fig. 38). Carry out the same operation on the louvres of the lower filter (Fig. 39). During cleaning, do not damage or scratch the coupling parts guaranteeing water seal, like the O-rings seat or the inlets of the flanges. During cleaning, do not wet the connector or the UM-CA-01 cable-carrier ring (Fig. 40).



Fig. 38



Fig. 39



Fig. 40

3. Clean and check integrity of the two O-rings, replacing them if required, and check their correct positioning inside the two seats arranged on the cylinder. Insert cylinder repeating the removal operations in reverse order, checking the exact positioning. Use the lubricant provided with the humidifier to lubricate the mechanical couplings to facilitate insertion operations.
4. Completely wash the cylinder two or three, using the "manual discharge" key.
5. After one hour of functioning from cylinder insertion, check there are no water leaks inside the humidifier.

CHAP. 8 STEAM DISTRIBUTION

8.1

GENERALITY



Good steam distribution to obtain the wanted humidity level in any ambient, is linked to 2 main variables: the amount of steam introduced in ambient and its distribution.

In fact, if the steam is not homogenously introduced in ambient, areas full or lacking in humidity are created, causing excessive condensation and difficult control of steam output, triggering a "swinging" effect.

It is advised to introduce steam using a PEGO steam distributor, inserting it inside the ventilation duct or in front of a fan unit where wanting to direct introduction in an ambient without duct.

8.2

EXAMPLE OF DISTRIBUTION IN DUCT

The PEGO steam distributor must be inserted transversally to the air flow in the duct.

To improve distribution yield, the distributor must cover as much air flow width as possible.

NB: The maximum airflow pressure in the duct must not exceed 1,200Pa (fig. 41).

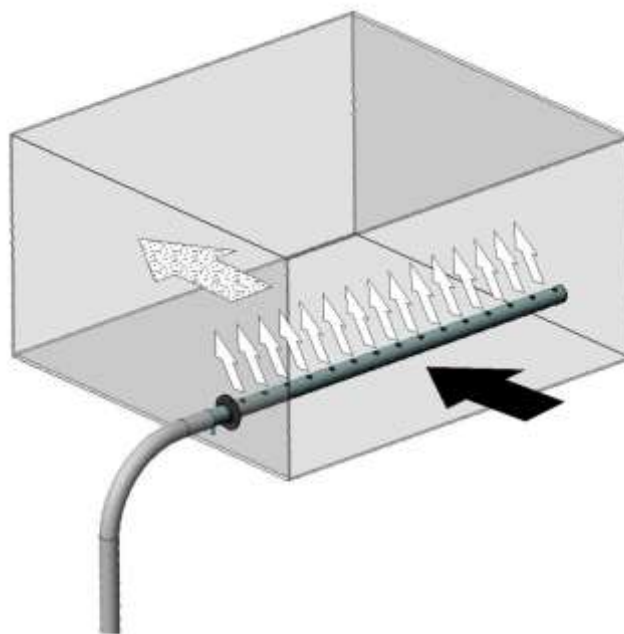

Fig. 41

8.3**EXAMPLE OF DISTRIBUTION IN AMBIENT**

The PEGO steam distributor must be inserted transversally in front of the air flow of a fan unit. To improve distribution yield, the distributor must cover as much air flow width as possible (fig. 42).

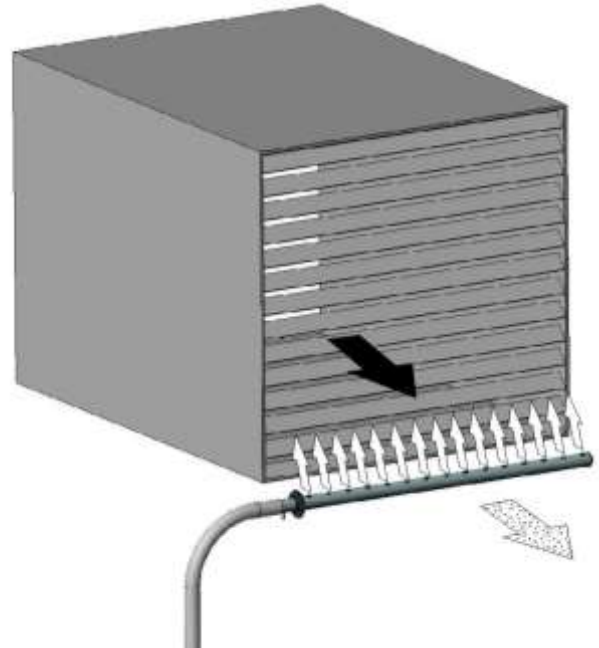

Fig. 42

8.4**CHOOSING A STEAM DISTRIBUTOR**

For the choice of the steam distributor, please visit our website www.pego.it, where you can find a large selection of stainless steel or aluminium distributors.



PEGO HUMIDIFIERS DIVISION offers the possibility of requesting customised steam distributors.

CHAP. 9 ATTACHMENTS

9.1

EU DECLARATION OF CONFORMITY

LA PRESENTE DICHIARAZIONE DI CONFORMITA' E' RILASCIATA SOTTO LA RESPONSABILITA' ESCLUSIVA DEL FABBRICANTE:
THIS DECLARATION OF CONFORMITY IS ISSUED UNDER THE EXCLUSIVE RESPONSIBILITY OF THE MANUFACTURER:



PEGO S.r.l. Via Piacentina 6/b, 45030 Occhiobello (RO) – Italy –

DENOMINAZIONE DEL PRODOTTO IN OGGETTO / DENOMINATION OF THE PRODUCT IN OBJECT

MOD.: 400ES100

IL PRODOTTO DI CUI SOPRA E' CONFORME ALLA PERTINENTE NORMATIVA DI ARMONIZZAZIONE DELL'UNIONE EUROPEA:
THE PRODUCT IS IN CONFORMITY WITH THE RELEVANT EUROPEAN HARMONIZATION LEGISLATION:

Direttiva Bassa Tensione (LVD): **2014/35/UE**
Low voltage directive (LVD): 2014/35/EU

Direttiva EMC: **2014/30/CE**
Electromagnetic compatibility (EMC): 2014/30/EU

LA CONFORMITA' PRESCRITTA DALLA DIRETTIVA E' GARANTITA DALL'ADEMPIMENTO A TUTTI GLI EFFETTI DELLE SEGUENTI NORME:
THE CONFORMITY REQUIRED BY THE DIRECTIVE IS GUARANTEED BY THE FULFILLMENT TO THE FOLLOWING STANDARDS:

Norme armonizzate:
European standards:

EN 60335-1:2012, EN 60335-2-98:2003, EN 55014-1:2006, EN 55014-2:2015, EN61000-3-2:2014,
 EN 61000-3-3:2013, EN 61000-3-11:2000, EN 61000-3-12:2011, EN 61000-6-1:2007, EN 61000-6-2 :2005,
 EN 61000-6-3:2007, EN 61000-6-4:2007.

IL PRODOTTO E' COSTITUITO PER ESSERE INCORPORATO IN UNA MACCHINA O PER ESSERE ASSEMBLATO CON ALTRI MACCHINARI PER COSTITUIRE UNA MACCHINA CONSIDERATE DALLA DIRETTIVA: 2006/42/CE "Direttiva Macchine".

THE PRODUCT HAS BEEN MANUFACTURED TO BE INCLUDED IN A MACHINE OR TO BE ASSEMBLED TOGETHER WITH OTHER MACHINERY TO COMPLETE A MACHINE ACCORDING TO DIRECTIVE: EC/2006/42 "Machinery Directive".

Firmato per nome e per conto di:
 Signed for and on behalf of:

Pego S.r.l.
 Lisa Zampini
 Procuratore Generale

Luogo e Data del rilascio:
 Place and Date of Release:

Occhiobello (RO), 08/01/2018

ES100 SERIES SPARE PARTS LIST

Code	Description
UMISIFONE1	Exceeding and deconcentration water discharge siphon
400UMSIF03	Siphon complete kit + tubes for water discharge for ES24, ES48 and ES100
UMICO25	DN25 lower flange
UMICO40	DN40 steam output flange for models ES24, ES48 and ES100
400UMCL03	Sunk-electrode cylinder for ES24, ES48 and ES100
UMIMOLLA3	Cylinder fixing spring for ES24, ES48 and ES100
UMITUBO10-3	Water charge tube (L=1600mm) for ES12, ES24 and ES100
400UMIVALV2	Solenoid valve 230V 50/60Hz for ES100
400POMPA943	230V 50/60 Hz asynchronous discharge pump
400KHUM2ES24	MasterHUM2 electronic control kit + NANO Display for ES24, ES48 and ES100
CON20241AL20	Power contactor, electrodes voltage supply for ES24, ES48 and ES100
UMIOR1	O-Ring diameter 88.49x3.53 SILICONE 60Sh.
UMICURVA90°	Sleeve curve 90° of 24mm
UMIOR3	FLAT GASKET Diameter: 90x97 Section: 6.5x3.5mm



The spare parts must be requested from own dealer.



PEGO s.r.l.

Via Piacentina, 6/b 45030 Occhiobello ROVIGO – ITALY

Tel. +39 0425 762906 Fax +39 0425 762905

e.mail: info@pego.it – www.pego.it



AFTER-SALES ASSISTANCE CENTRE

Tel. +39 0425 762906 e.mail: tecnico@pego.it

Distributor: