

IMMERSED ELECTRODES
HUMIDIFIERS
EASYSTEAM
ES-OEM-CCU



Use and maintenance manual

READ AND KEEP

Rel. 19

Thank you for choosing a PEGO EASYSTEAM ES-OEM-CCU immersed electrodes humidifier.

The complete reading of this manual will allow you to perform a correct installation and a better use of the machine. It is therefore advisable to keep this manual in a place adjacent to the humidifier for any maintenance operations or to modify its operation.

How to read the manual.

To facilitate reading, graphic indications have been inserted with the following meanings:



Indicates a note that require careful reading.



Indicates the operations to be scrupulously performed to avoid damage to the humidifier, injury to persons or malfunctions.



Indicates the operations not to be performed to avoid damage to the humidifier, injury to persons or malfunctions.



Indicates a suggestion.



Indicates to contact the PEGO after-sales service indicated on the back of this manual.

Instructions for disposal:

The humidifier is made up of metal parts and plastic parts. In reference to European Union directive 2012/19/EC issued on 4 July 2012 and the related national legislation, please note that:

- A. WEEE cannot be disposed of as municipal waste and such waste must be collected and disposed of separately.
- B. The public or private waste collection systems defined by local legislation must be used. In addition, the equipment can be returned to the distributor at the end of its working life when buying new equipment.
- C. The equipment may contain hazardous substances: the improper use or incorrect disposal of such may have negative effects on human health and on the environment.



- D. The symbol  (crossed-out wheeled bin) shown on the product or on the packaging and on the instruction sheet indicates that the equipment has been introduced onto the market after 13 August 2005 and that it must be disposed of separately.
- E. In the event of illegal disposal of electrical and electronic waste, the penalties are specified by local waste disposal legislation.

TABLE OF CONTENTS

INTRODUCTION

CHAP. 1

| | | |
|---------|-----|--|
| Page 5 | 1.1 | Generality |
| Page 6 | 1.2 | Warranty conditions |
| Page 7 | 1.3 | Functioning principle |
| Page 9 | 1.4 | ES-OEM-CCU Series humidifiers identification codes |
| Page 9 | 1.5 | ES-OEM-CCU Series humidifiers technical data |
| Page 10 | 1.6 | Overall dimensions |
| Page 10 | 1.7 | Identification data |
| Page 10 | 1.8 | Standard equipment |



INSTALLATION

CHAP. 2

| | | |
|---------|------|---|
| Page 11 | 2.1 | Main installation warnings |
| Page 13 | 2.2 | ES-OEM-CCU series sensors and control signals connections |
| Page 18 | 2.3 | Digital inputs on HUM2 board |
| Page 19 | 2.4 | Digital outputs on HUM2 board |
| Page 20 | 2.5 | TA Inputs for measuring current absorption |
| Page 20 | 2.6 | Net configuration with Modbus-RTU protocol |
| Page 20 | 2.7 | Board power supply |
| Page 20 | 2.8 | NANO EasySTEAM Display for Master HUM2 board |
| Page 21 | 2.9 | ES-OEM-CCU series electrical layouts |
| Page 23 | 2.10 | Installing the ES-OEM-CCU series humidifier |
| Page 25 | 2.11 | ES-OEM-CCU series humidifier electric connections |



PROGRAMMING

CHAP. 3

| | | |
|---------|-----|---------------------------------------|
| Page 26 | 3.1 | NANO EasySTEAM controller description |
| Page 27 | 3.2 | Combination of keys |
| Page 28 | 3.3 | Status LED on Master HUM2 electronics |
| Page 29 | 3.4 | 1st Level programming |
| Page 30 | 3.5 | 2st Level programming |

MASTER/SLAVE CONFIGURATION

CHAP. 4

| | | |
|---------|-----|--|
| Page 35 | 4.1 | Individual humidifier configuration |
| Page 35 | 4.2 | Master/Slave humidifiers configuration |

IGNITING THE HUMIDIFIER

CHAP. 5

| | | |
|---------|-----|---------------------------------------|
| Page 38 | 5.1 | First ignition |
| Page 38 | 5.2 | Steam production |
| Page 38 | 5.3 | Smart production for low conductivity |

DIAGNOSTICS

CHAP. 6

| | | |
|---------|--|-------------|
| Page 39 | | Diagnostics |
|---------|--|-------------|

**MAINTENANCE****CHAP. 7**

| | | |
|---------|-----|------------------------------|
| Page 43 | 7.1 | Maintenance |
| Page 43 | 7.2 | General and safety Standards |
| Page 43 | 7.3 | Maintenance intervals |
| Page 45 | 7.4 | Replacement of the cylinder |
| Page 47 | 7.5 | Cleaning the cylinder |

STEAM DISTRIBUTION**CHAP. 8**

| | | |
|---------|-----|-------------------------------------|
| Page 48 | 8.1 | Generality |
| Page 48 | 8.2 | Example of distribution in air duct |
| Page 49 | 8.3 | Example of distribution in ambient |
| Page 49 | 8.4 | Choosing a steam distributor |
| Page 49 | 8.5 | Condensation recovery |

ATTACHMENTS**CHAP. 9**

| | | |
|---------|-----|-------------------------------|
| Page 50 | 9.1 | EU Declaration of Conformity |
| Page 51 | 9.2 | ES-OEM-CCU Series spare parts |

CHAP.1 INTRODUCTION

1.1

GENERALITY

The family of Pego EASYSTEAM OEM-CCU immersed electrode humidifiers can be considered as the most complete by type of use and ease of maintenance.

The line includes humidifiers with 3kg/h and 6kg/h production capacity with single-phase electric power supply, all able to work in ON/OFF mode, proportional mode with integrated humidistat and 4-20mA or 0-10V probe, proportional mode with 0-10V external signal, in ON/OFF mode from integrated thermostat and proportional mode from integrated thermostat.

The EASYSTEAM humidifiers are provided with a microprocessor software enabling the widest programming for a fully customised use and a completely automatic functioning.

In fact, it is possible to set the maximum capacity of steam production, values of production capacity intermediate in percentage, the frequency of deconcentration discharges, the discharge of water for inactivity.

The EASYSTEAM line is also provided with a display for real time viewing of the humidity in the premises to be treated; the current absorbed by the electrodes, the hours of work, various alarms, water charging and discharging as well as all easily settable programming parameters.

An acoustic alarm (buzzer) is present in the EASYSTEAM humidifiers that warns the user of any anomalies; the internal software is able to evaluate the seriousness of the anomaly, blocking the machine or continuing the steam supply.

The strength of the EASYSTEAM line is the simplicity with which the cylinder is replaced when normal wear makes it necessary.



The **EASYSTEAM** series humidifiers are covered by a 24-months warranty against all manufacturing defects as from the date indicated on the product ID code.

In case of defect the product must be appropriately packaged and sent to our production plant or to any authorized Service Center with the prior request of the Return Authorization Number.

Customers are entitled to have defective products repaired, spare parts and labour included. The costs and the risks of transport are at the total charge of the Customer.

Any warranty action does not extend or renew its expiration.

The Warranty does not cover:

- Damages resulting from tampering, impact or improper installation of the humidifier and its accessories.
- Installation, use or maintenance that does not comply with the instructions provided with the humidifier.
- Repair work carried out by unauthorized personnel.
- Consumables (immersed electrodes cylinders).
- Damages due to natural phenomena such as lightning, natural disasters, etc.

In all these cases the costs for repair will be charged to the customer.

The intervention service in warranty can be refused when the equipment is modified or transformed.

Under no circumstances **Pego S.r.l.** will be liable for any loss of data and information, costs of goods or substitute services, damage to property, people or animals, loss of sales or earnings, business interruption, any direct, indirect, incidental, consequential, damaging, punitive, special or consequential damages, in any way whatsoever caused, whether they are contractual, extra contractual or due to negligence or other liability arising from the use of the product or its installation.

Malfunction caused by tampering, bumps, inadequate installation automatically declines the warranty. It is compulsory to observe all the instructions in this manual and the operating conditions of the product.

Pego S.r.l. disclaims any liability for possible inaccuracies contained in this manual if due to errors in printing or transcription.

Pego S.r.l. reserves the right to make changes to its products which it deems necessary or useful without affecting its essential characteristics.

Each new release of the Pego product user manual replaces all the previous ones.

As far as not expressly indicated, is applicable the Law and in particular the art. 1512 C.C. (Italian Civil Code).

For any controversy is elected and recognized by the parties the jurisdiction of the Court of Rovigo.

1.3

FUNCTIONING PRINCIPLE

The immersed electrode humidifiers of the series EASYSTEAM, exploit the conductivity of water for food use for the production of steam by boiling.

In the cylinder, an electric current is triggered between the immersed electrodes; this overheats the water until it is brought to the boiling temperature.

The current intensity, expressed in amperes, varies according to the quantity of water present in the cylinder and in contact with the surface of the electrodes and its conductivity.

The electronics present in the humidifier is able, thanks to an amperometric transformer, to measure this intensity of current and therefore, by controlling the load solenoid valve to raise the water level in the cylinder or the drain pump to lower it, it succeeds to control this phenomenon in an absolutely automatic way.

Furthermore, thanks to a microprocessor technology and to a humidity sensor, proportional operation can be set, optimizing the consumption of water and electricity according to the humidity requirements of the environment to be treated.

In addition to ensuring functioning during steam output, the discharge pump also guarantees the complete cylinder draining when the unit has been inactive for a set time: this prevents the formation and the deposit of limescale or other particles created during the boiling process.

The EASYSTEAM series humidifiers are fully automatic and require only replacement of the cylinder when the electrodes are worn.

The layout below illustrates the functioning principle.

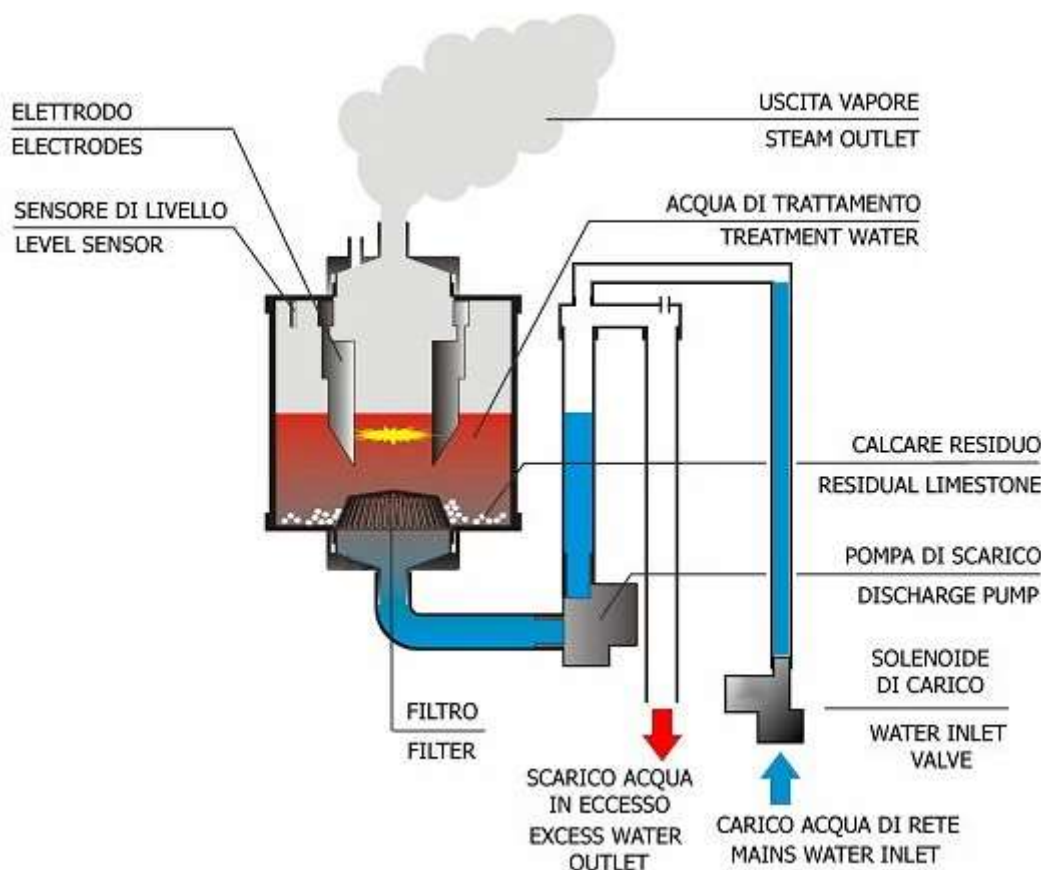

The supplied steam is managed proportionally to steam production request that the electronic control calculates depending on the chosen functioning among the eight available, described in chap. 2.4.

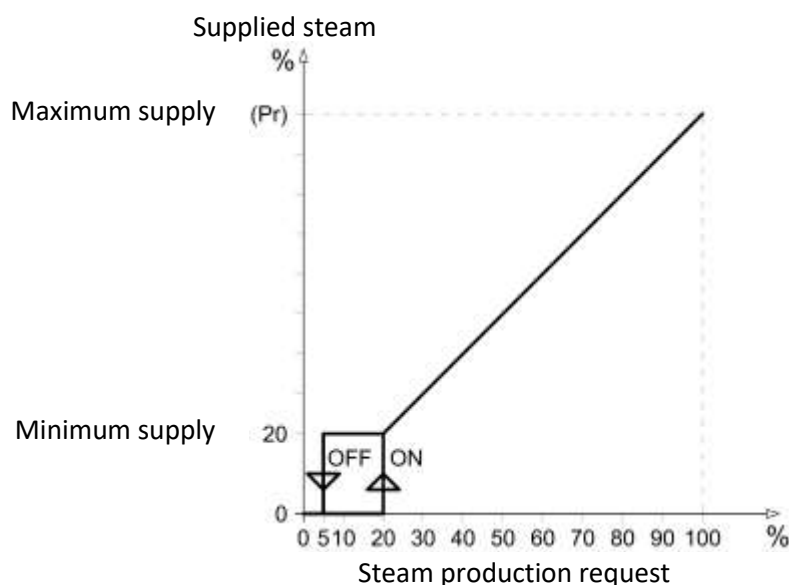

The minimum steam supply is set at 20% of the rated maximum current (independently of Pr) and is managed with an activation hysteresis; the maximum supply, which occurs at a maximum production request, corresponds to the percentage set in the first level variable (Pr). If for example on an ES6 that produces 6kg/h of steam, the variable Pr is set to 100% the maximum production will be 6kg/h; but if the variable Pr is reduced to 50%, the maximum production will be 3kg/h.



For correct operation, the humidifier must be supplied with drinking water coming from the aqueduct; this is because it is free from any element harmful to health and is compatible with the range of conductivity useful for optimal operation of the humidifier. However, in some geographical areas mains water may be unsuitable for optimal functioning due to very low conductivity or high hardness or because it's too aggressive; the below is a summary table of the parameters required for correct humidifier functioning.

| POTABLE WATER FUNCTIONING RANGE | | LIMITS with standard cylinder | | | LIMITS with cylinder for low conductivity | | |
|--|------------------------|-------------------------------|-----|------|---|-----|-----|
| PARAMETER | UNIT OF MEASURE | MIN | OPT | MAX | MIN | OPT | MAX |
| Water conductivity at 20°C * | µS/cm | 250 | 400 | 1300 | 125 | 200 | 350 |
| pH | | 7 | 8 | 8,5 | 7 | 8 | 8,5 |
| Hardness | mg/l CaCO ₃ | 160 | 200 | 450 | 60 | 120 | 160 |
| Chlorine | ppm Cl ₂ | 0 | 0 | 0,2 | 0 | 0 | 0,2 |
| Chlorides | mg/l Cl ⁻ | 0 | <25 | 250 | 0 | <20 | 100 |
| Calcium sulphate | mg/l CaSO ₄ | 0 | 0 | 95 | 0 | 0 | 55 |
| Metal impurities / Solvents / Soaps / Lubricants | mg/l | 0 | 0 | 0 | 0 | 0 | 0 |
| Temperature | °C | +1 | +20 | +40 | +1 | +20 | +40 |

MIN = minimum - OPT = optimal - MAX = maximum

* Water conductivity is always expressed at 20°C; bear in mind that conductivity decreases as water temperature drops and so water may not be very conductive during winter when mains water is particularly cold.



In case of very low conductivity, consult chapter 5.3 on page 38 of this manual: Intelligent production for low conductivity.



Do not supply the humidifier with well water or treated with osmosis purifiers, demineralisers or softeners or taken from cooling circuits.

1.4
ES-OEM-CCU SERIES HUMIDIFIERS IDENTIFICATION CODES

- 400ES3MOEMCCU** Single-phase OEM humidifier with 3kg/h steam production capacity, completed with electronics kit with ten selectable operating modes.
- 400ES6OEMCCU** Three-phase OEM humidifier with 6kg/h steam production capacity, completed with electronics kit with ten selectable operating modes.

1.5
OEM CCU SERIES HUMIDIFIERS IDENTIFICATION CODES

| TECHNICAL DATA AND WORKING CONDITIONS | 400ES3MOEMCCU | 400ES6OEMCCU |
|---|---|-----------------|
| STEAM PRODUCTION (in kg/h) | 3 | 6 |
| ELECTRIC POWER SUPPLY | 230V 50Hz * | 400V 3/N 50Hz * |
| POWER (kW) | 2 | 4,5 |
| ABSORBED CURRENT (A) | 9 | 6,5 |
| TYPE OF CONTROL | Display NANO + Master HUM2 EASYSTEAM ES-MINI series | |
| ELECTRONIC CONTROL POWER SUPPLY | 230V 50-60Hz | |
| STEAM OUTLET DIAMETER (mm) | 25 | 25 |
| CYLINDERS NUMBER | 1 | 1 |
| VACUUM WEIGHT (kg) | 2,5 | 2,5 |
| WEIGHT WITH OPERATIONAL UNIT (kg) | 5 | 5 |
| WATER SUPPLY PRESSURE | 1-10 bar | |
| FUNCTIONING AMBIENT TEMP. | +1 ÷ +50 °C | |
| FUNCTIONING AMBIENT HUMIDITY | < 60 %RH (90 %RH non condensing) | |
| STORAGE TEMPERATURE | -10 ÷ +70 °C | |
| PROTECTION RATING | IP00 | |
| ELECTRONIC CONTROL FUNCTIONING AMBIENT TEMP. | +0 ÷ +60 °C | |
| ELECTRONIC CONTROL FUNCTIONING AMBIENT HUMIDITY | < 60 %RH (90 %RH non condensing) | |
| ELECTRONIC CONTROL PROTECTION RATING | IP20 | |

FOR DIFFERENT NEEDS, ARE AVAILABLE MODELS WITH OTHER SPECIFICATIONS.

*** 60HZ VERSION AVAILABLE ON REQUEST.**

FOR FURTHER INFORMATIONS CONTACT US.

1.6

OVERALL DIMENSIONS

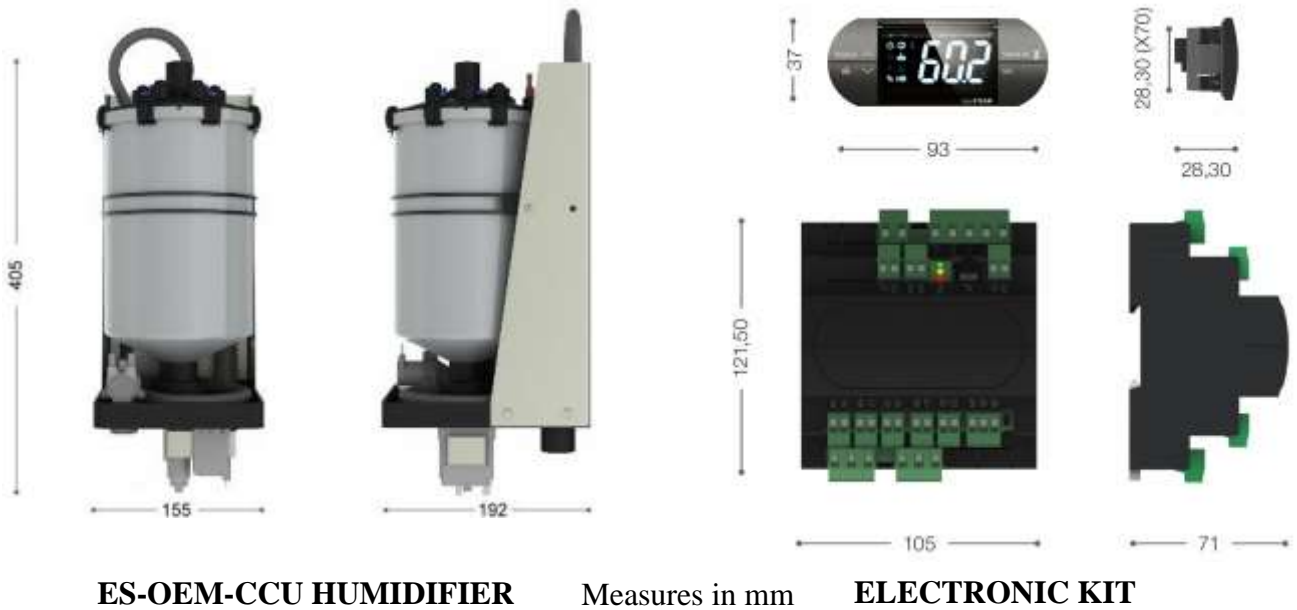

1.7

IDENTIFICATION DATA

The appliance described in this manual is provided with a plate on the side reporting the identification data of the same:

- Manufacturer Name
- Code of appliance
- Production Lot
- Power supply voltage
- Nominal current

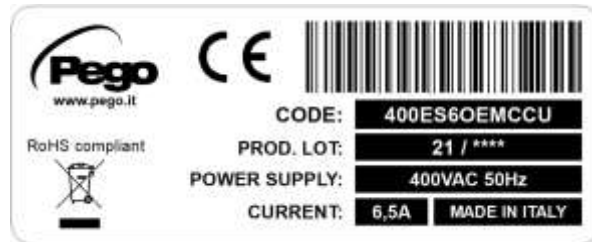

1.8

STANDARD EQUIPMENT

For assembly and use, the EASYSTEAM line humidifiers are provided with:

- Nr 1 3/4 gas connection for water load.
- Nr 1 32mm external diameter connection for water discharge.
- Nr 1 25mm external diameter connection for the steam tube.
- Nr 1 User manual.
- Nr 1 Test checklist which reports:
 - Humidifier model.
 - Default configuration.
 - Steam production at 100%.
 - Electric power supply type.
 - Absorbed power in kW.
 - Nominal absorbed current.
- Nr 1 Electronics KIT (only for OEM series models).
 - MASTER HUM2 (electronic control board with PEGO EasySTEAM software).
 - NANO EasySTEAM (display for viewing status and settings).
 - Toroid (current absorption sensor).

CHAP. 2 INSTALLATION

2.1

MAIN INSTALLATION WARNINGS



1. The installation, maintenance and use of the appliance must be carried out by qualified personnel able to safely perform the requested operations. Carefully read this manual before performing any operations and follow all its indications.
2. Install the appliance as close as possible to the environment where the steam is to be introduced, namely in the position that guarantees the shorter length of the steam pipe. We recommend not to exceed 5 meters.
3. Install the appliance at a height that allows easy access to the control unit for parameter adjustment and viewing of the display. We recommend a height from the ground of about 1 meter.
4. Install the appliance at a height that allows easy access to the inside of the humidifier for cylinder replacement.
5. Some parts of the humidifier, during operation, may exceed the temperature of 60°C. Make sure that the surfaces in contact with the humidifier are compatible with these values.
6. Do not install and use the humidifier near products or objects that can be damaged in contact with water or the humidity produced.
7. Avoid placing power cables with signal cables in the same conduit (probes and digital inputs).
8. Reduce the lengths of the connecting cables as much as possible, avoiding that the wiring takes up the spiral shape, which is harmful for possible inductive effects on the electronics.
9. Install a magneto thermal protection switch, upstream of the humidifier.
10. All conductors used in the wiring must be appropriately proportioned to support the load they are to supply.
11. If it is necessary to extend the probe, it is necessary to use conductors with a suitable section and in any case not less than 1mm².
12. Connect a pipe with a diameter of not less than 32mm to the drain hose. This pipe must be firmly clamped to the drain sleeve and have vertical development for at least the first 50cm. Make sure that you do not create bottlenecks and do not exceed with its height, at any point in the path, the level of the drain sleeve.
13. Use only drinking water for the water load, with a pressure between 1 and 10 bar.

14. Check the default setting shown on the enclosed TEST CHECKLIST, before starting up the humidifier. If the default setting is different from your needs, set the parameters as indicated in chapter 3 and in accordance with the connections indicated in chapter 2.4.
15. With the default setting of parameter In1=2, the humidifier to work requires the digital input 1 to be enabled by means of a voltage free contact (terminals 24 and 25 on the electronic board Master HUM2) regardless of the selected operating mode.
16. If it is not necessary to use an external enable, jumper the terminals 24 and 25 on the Master HUM2 electronic board or set the parameter In1=0.
17. Without enabling, the display alternates the word OFF with normal displaying.

The humidifier has ten different operating modes that can be set by the software variable S9 described in chapter 3.5 and by specific electrical connections.

It is also necessary to enable the digital input In1 terminals 24 and 25 on the electronic board Master HUM2 for all operating modes (enabling = closed contact between clamps 24 and 25). See the parameter settings In1, In2 and In3 for all possible enablements. Without enabling, the display alternates the OFF writing with normal displaying.

Below are the specific connections for every functioning mode.



If you want to connect the humidifier with a humidity probes not supplied by PEGO s.r.l., contact the after-sales assistance to verify the hardware compatibility between the probe and the humidifier.

- **[S9=0] ON/OFF Functioning:**

This type of operation involves the production of steam in only 2 modes: no production or production at full capacity. The consent is usually given by a voltage free contact coming from an electrical panel which, in turn, is controlled by a humidistat. Set the second level variable **S9=0** and connect the consent to clamps **24** and **25** of the Master HUM2 board (Enabling present with closed contact).

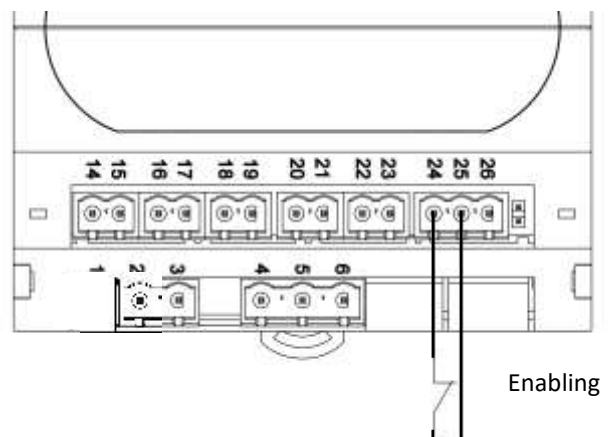
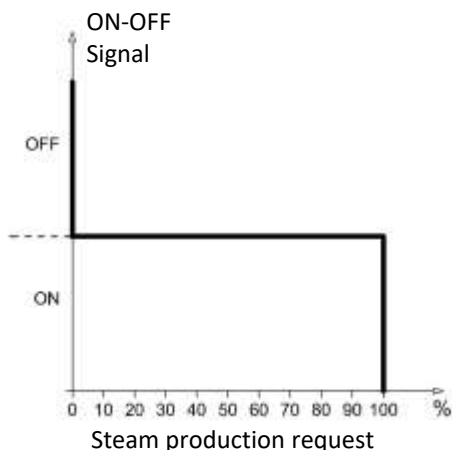

Cleaning function (CL1>0):

If **CL1>0**, when the steam production reaches **CL2%** the humidifier continues to work for **CL1** minutes, then returns to stand-by (the buzzer sounds for 1 minute to signal the end of the cleaning procedure). With **CL1>0**, the humidifier always remains in stand-by until the function is manually activated, which is obtained by pressing the stand-by key.

- **[S9=1] PROPORTIONAL functioning with 4-20mA ambient humidity probe (INTEGRATED HUMIDISTAT):**

This type of operation involves proportional steam production; the humidifier will automatically regulate the steam production according to the request in the environment depending to the set point. The consent is provided by a humidity probe at 4-20mA (0-100% RH) which, in addition to regulating steam production, allows to show the relative humidity of the environment directly on the humidifier display. Set the second level variable **S9=1** and connect the signal 4-20mA of the humidity probe to clamps **14** and **15**; in particular, connect the RH signal to clamp **14**, and connect +V to clamp **15**.

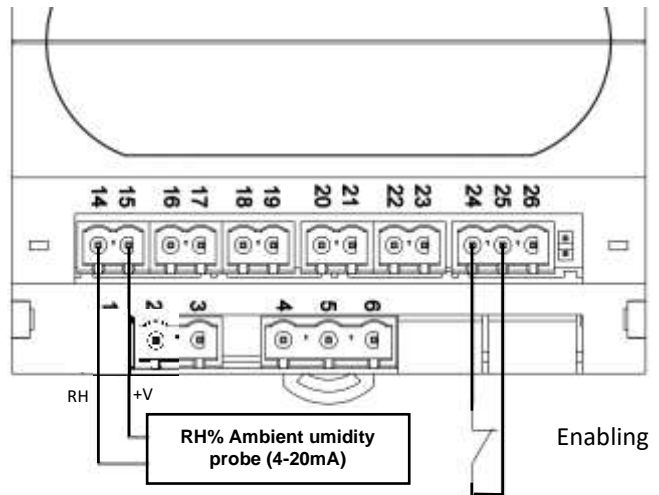
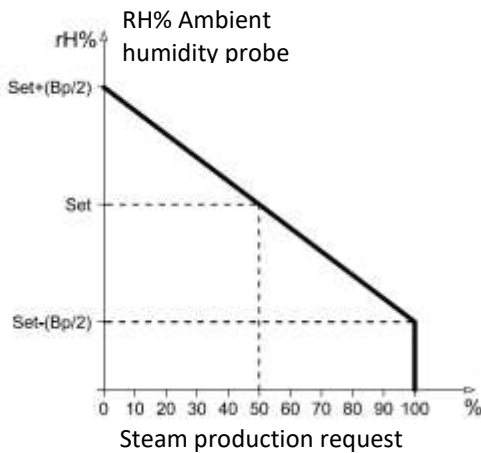

The Bp proportional band is the percentage value of humidity around the set point; the humidifier works proportionally within this value. Example: if the proportional band is set on default value 10% ($\pm 5\%$ set point value) and humidity is set at 50%, below 45% the humidifier will work at 100% of steam production; above 55%, the humidifier will not produce steam. Between 45% and 55%, the humidifier will optimally regulate steam production.

- **[S9=2] PROPORTIONAL functioning with 0-10Vdc reference signal:**

This type of operation involves the production of steam proportionally to the reference signal 0-10Vdc. Example: a reference signal of 6Vdc will allow the humidifier to produce 60% of steam production referred to the software variable Pr. So, if Pr = 70%, steam production will be 42%. Set the second level variable **S9=2** and connect the signal of reference 0-10V to clamps **16** and **17**; in particular, connect VRH (0-10Vdc probe output) to clamp 16 and GND mass to clamp **17**.

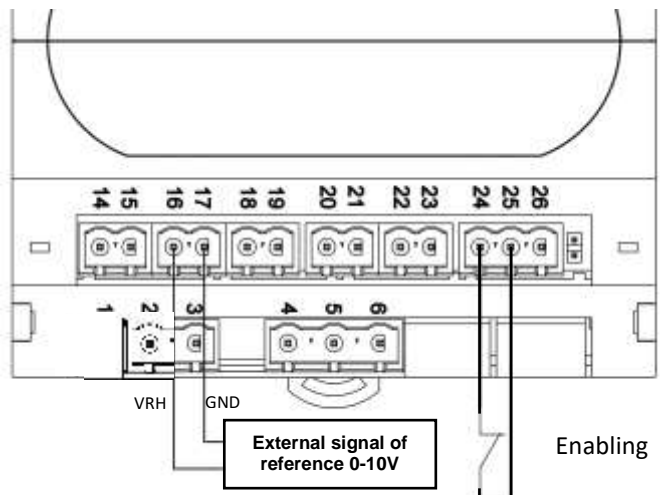
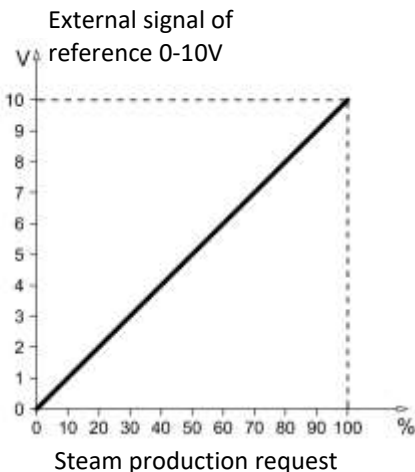

- [S9=3] **PROPORTIONAL functioning with 4-20mA ambient humidity probe + 4-20mA humidity probe in air duct (INTEGRATED HUMIDISTAT):**

This type of operation involves proportional steam production; the humidifier will automatically regulate the steam production according to the request in the environment depending to the set point and to the value measured in duct.

Set the second level variable **S9=3**, connect the 4-20mA signal of ambient humidity probe (0-100%RH) to clamps **14** and **15**; in particular, connect RH signal to clamp **14** and +V to clamp **15**. Connect 4-20mA signal of humidity probe in air duct (0-100%RH) to clamps **20** and **21**; in particular, connect signal RH to clamp **20** and +V to clamp **21**. For further information on the humidity probe in air duct, refer to chapter 3 “Programming” (variables StC, r0, t1).

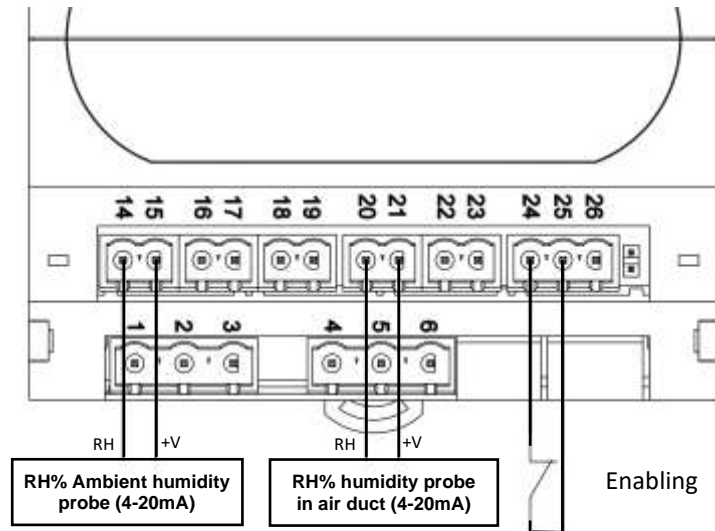

- [S9=4] **PROPORTIONAL functioning with 0-10Vdc reference signal + humidity probe in air duct (4-20mA):**

This type of operation involves the production of steam proportionally to the 0-10Vdc reference signal and to the humidity measured in duct.

Set the second level variable **S9=4** and connect the 0-10Vdc reference signal to clamps **16** and **17**; in particular, connect VRH to clamp **16** and GND mass to clamp **17**. Connect 4-20mA signal of humidity probe in air duct (0-100%RH) to clamps **20** and **21**; in particular, RH signal to clamp **20** and +V to clamp **21**.

For further information on the humidity probe in air duct, refer to chapter 3 “Programming” (variables StC, r0, t1).

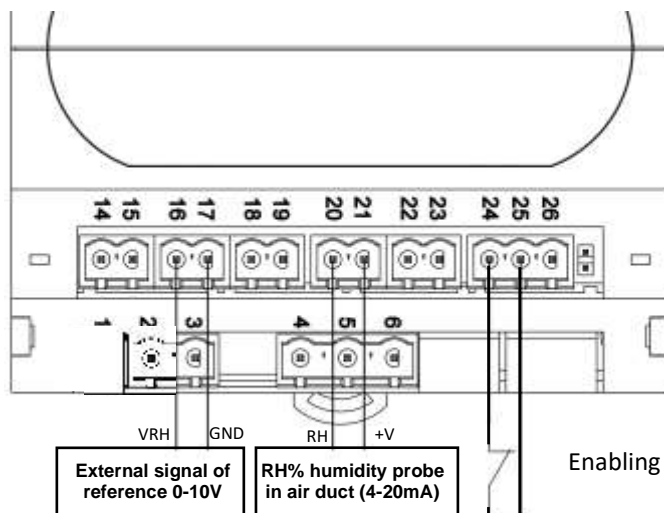

- [S9=5] **PROPORTIONAL functioning with 0-10Vdc ambient humidity probe (INTEGRATED HUMIDISTAT):**

This type of operation involves proportional steam production; the humidifier will automatically regulate the steam production according to the request in the environment depending to the set point. The consent is provided by a 0-10Vdc humidity probe (0-100%RH) that, in addition to regulating steam production, allows to show the relative humidity of the environment directly on the humidifier display. Set the second level variable **S9=5** and connect 0-10Vdc signal of the humidity probe to clamps **16** and **17**; in particular, connect VRH signal to clamp **16** and connect GND to clamp **17**.

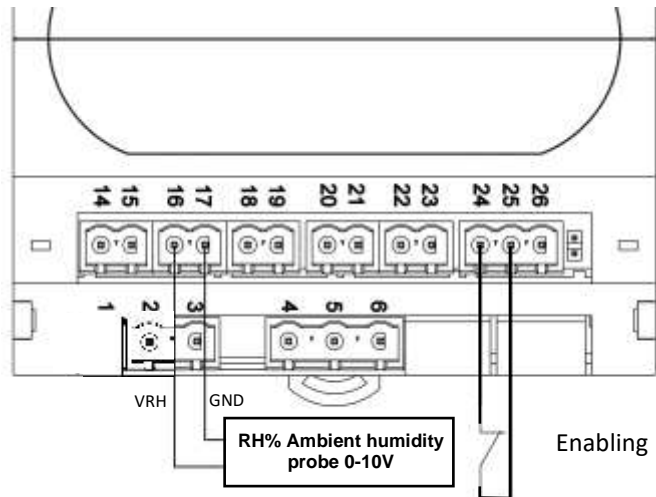
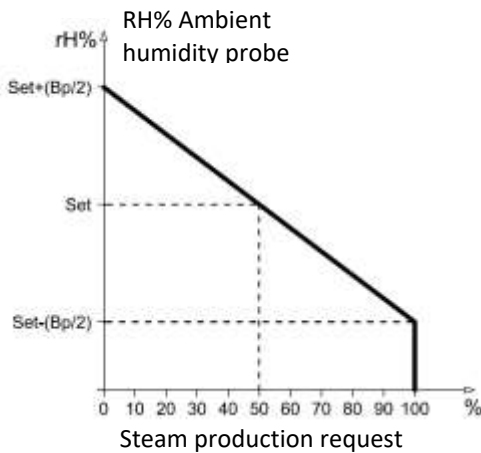

The Bp proportional band is the percentage value of humidity around the set point; the humidifier works proportionally within this value. Example: if the proportional band is set on default value 10% ($\pm 5\%$ set point value) and humidity is set at 50%, below 45% the humidifier will work at 100% of steam production; above 55%, the humidifier will not produce steam. Between 45% and 55%, the humidifier will optimally regulate steam production.

- [S9=6] **PROPORTIONAL functioning with 0-10Vdc ambient humidity probe + 0-10Vdc humidity probe in air duct (INTEGRATED HUMIDISTAT):**

This type of operation involves proportional steam production; the humidifier will automatically regulate the steam production according to the request in the environment depending to the set point and to the value measured in duct.

Set the second level variable **S9=6** and connect signal 0-10Vdc of the humidity probe (0-100%RH) to clamps **16** and **17**; in particular, connect VRH signal to clamp **16** and connect GND to clamp **17**. Connect the humidity probe in air duct signal 0-10Vdc (0-100%RH) to clamps **22** and **23**; in particular, connect VRH signal to clamp **22** and GND to clamp **23**.

For further information on the humidity probe in air duct, refer to chapter 3 "Programming" (variables StC, r0, t1).

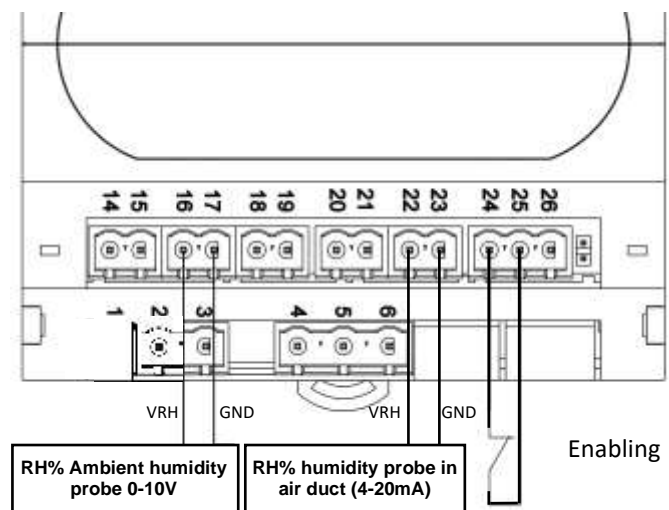

- [S9=7] **Functioning with integrated thermostat (ON/OFF hot call):**

This type of operation involves the production of steam in only 2 modes: no production or production at full capacity which is activated when the temperature measured by the ambient probe falls below the value of SET POINT-r1 and remains active until the temperature increases and exceeds the SET POINT.

Set the second level variable **S9=7** and connect the NTC temperature probe to clamps **18** and **19** of the Master HUM2 electronic board.

(r1=Temperature differential referred to set point)

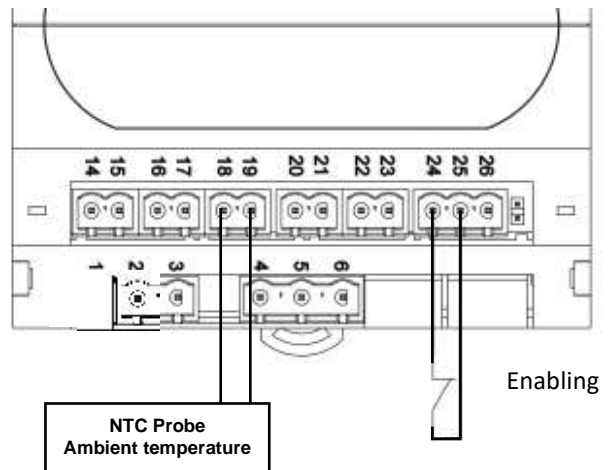
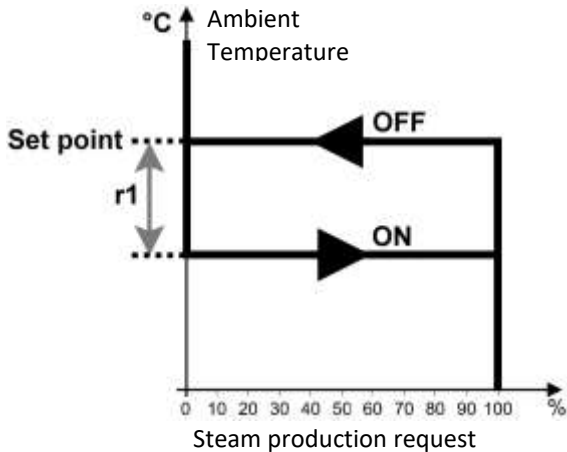

In this mode, it is possible to set the two configurable outputs (Do4 and Do5 already wired on terminals 62 and 63, in tension) to manage a few typical functions of a sauna or a Turkish bath, such as the essence inlet, the management of outlet or inlet fans.

Essence Management (dO4 or dO5 = 4):

In a Turkish bath the essence is provided (with the times set in t2 and t3) when the humidifier is producing steam and the temperature measured by the ambient probe is higher than 70% of the set point. By using the key combination arrow up + Stand-by is possible at any time to enable or disable the inlet of the essence; in particular, the current status is displayed after pressing the key combination for three seconds (**EoF** = essence OFF or **Eon** = essence ON) and by continuing to hold the keys pressed for another three seconds, the state is switched.

Inlet fan (dO4 or dO5 = 3):

The inlet fan is usually used to introduce or mix the steam in the room. The relay linked to this function is activated when there is a steam production request (it remains active even during the phases of water discharge for deconcentration or due to overcurrent) and it is deactivated with the delay set in parameter t6 after the end of the steam production request. If parameter t6 is set to -1, the inlet fan run in continuous gear (active even during stand-by or alarms).

Outlet fan (dO4 or dO5 = -3):

The outlet fan is usually used to ensure air exchange and to create the fog effect. The relay linked to this function is activated when there is no steam production request. It is also possible to start a drying cycle at the end of the day; with the humidifier in stand-by, press the keys arrow down + Stand-by to activate the cycle that is indicated on the display with the writing **Uon** = outlet fans ON. In this phase the output of the outlet fan remains active for the hours set in the variable t4. To stop this cycle, simply exit the stand-by status.

Cleaning function (CL1>0):

If **CL1>0**, when the temperature reaches the setpoint the humidifier continues to work for CL1 minutes, then returns to stand-by (the buzzer sounds for 1 minute to signal the end of the cleaning procedure). With **CL1> 0**, the humidifier is always in stand-by until the function is manually activated, which is obtained by pressing the stand-by key.

- [S9=8] **PROPORTIONAL functioning REFERRED TO VALUE SENT ON RS485 (0-100%):**

This type of operation involves the production of steam proportionally to the value set in register 1537 by means of Modbus-RTU communication.

In this operating mode, the commands to force water discharge and produce steam have a time-out of 1 minute; if during this period the command is not sent again on Modbus, at the end of this time the steam production will be set to zero and the drain pump will be disabled.

This secures the humidifier in case of accidental disconnection of the communication network.

Set the second level variable **S9=8** and connect the instrument to the RS485 line with clamp 32 to line A (TX+) and clamp 31 to line B (TX-). For further information on Modbus-RTU Protocol of the humidifier, refer to document "MODBUS-RTU_UMIDMS03".

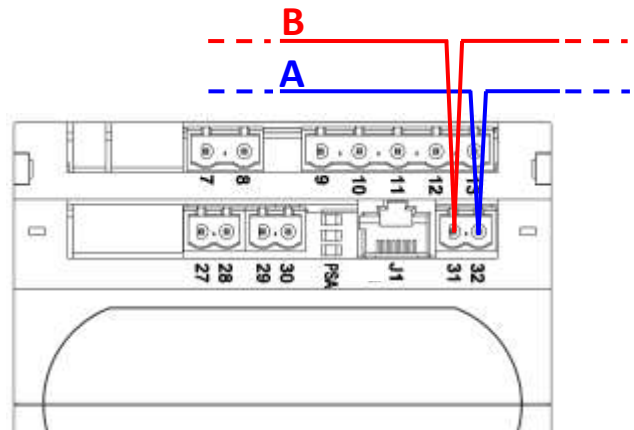

- [S9=9] **PROPORTIONAL functioning with NTC ambient temperature probe (INTEGRATED THERMOSTAT):**

This type of operation involves proportional steam production; the humidifier will automatically regulate the steam production according to the request in the environment depending to the set point. The consent is provided by a NTC ambient probe that, in addition to regulating steam production, allows to show the ambient temperature directly on the humidifier display. Set the second level variable **S9=9** and connect the NTC temperature probe to clamps 18 and 19 of the Master HUM2 electronic board.

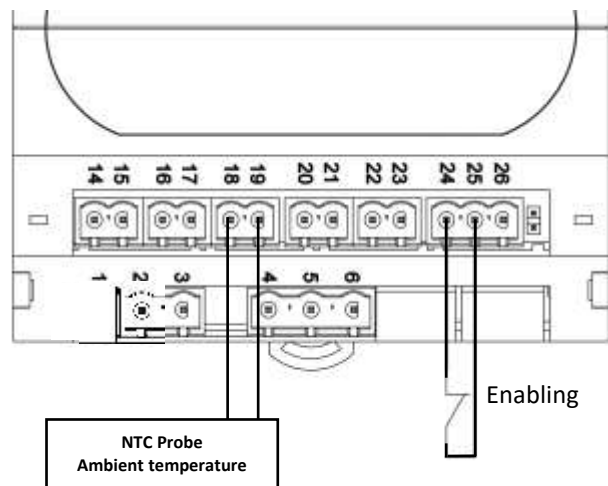
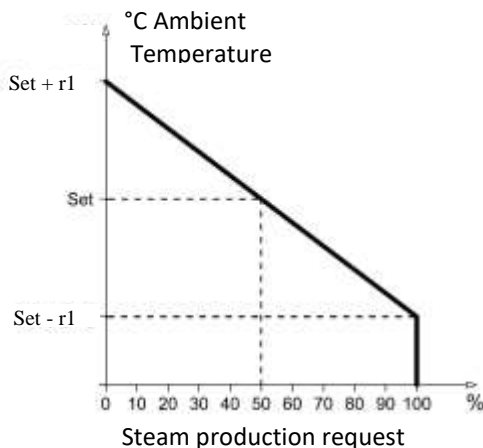

The $2 \cdot r1$ proportional band is the value in degrees Celsius ($^{\circ}\text{C}$) around the temperature set point; within this band the humidifier works proportionally.

Essence Management (dO4 or dO5 = 4):

See mode S9=7.

Inlet fan (dO4 or dO5 = 3):

See mode S9=7.

Outlet fan (dO4 or dO5 = -3):

See mode S9=7.

Cleaning function (CL1>0):

See mode S9=7.

2.3

HUM2 BOARD DIGITAL INPUTS

On the electronics of the humidifier there are four digital inputs with the following meaning:
Digital inputs In1, In2 are in low voltage.

Input In1 (clamps 24 and 25): input with configurable meaning based on the second level variable In1. By default, this input is configured as "main enable": enable with closed contact between terminal 24 and 25.

Input In2 (clamps 24 and 26): input with configurable meaning based on the second level variable In2. the input is active when the contact between terminals 24 and 26 is closed or by means of the jumper on the board, next to terminal 26. By default, this input is configured as "discharge pump activation" to enable emptying the cylinder in case the console is not present.

Digital inputs In3, In4 are in high alternate voltage (mains voltage).

These inputs hear the mains voltage and for their operation require the connection of one of the two phases (in our case the neutral) to the clamp 4.

Input In3 (clamps 4<neutral> and 6<phase>): input with configurable meaning based on the second level variable In3. The input is active with phase input to clamp 6.

Input In4 (clamps 4<neutral> and 5<phase>): input for maximum water level in the cylinder, active with phase input to clamp 5.

In ES series humidifiers input In4 is already wired. If none of the inputs In1, In2 and In3 are configured as enablement, the humidifier does not need external enabling to operate.

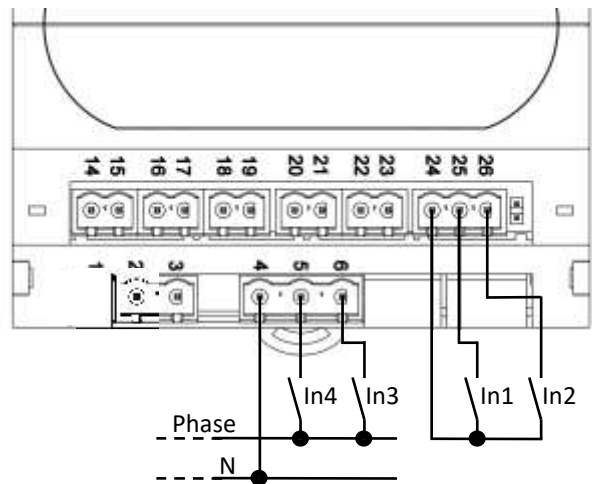

2.4

HUM2 ELECTRONIC BOARD DIGITAL OUTPUTS

On the electronics of the humidifier there are five relays, two of which with configurable function. The digital outputs Do1, Do2, Do3 and Do5 are normally open contacts with a single common (terminal 9) while the output Do4 is independent and galvanically isolated, in particular:

Output Do1 (clamps 9 and 10): Electrodes.

Output Do2 (clamps 9 and 11): water load EV.

Output Do3 (clamps 9 and 12): Discharge pump.

Output Do5 (clamps 9 and 13): Configurable relay humidifier, in tension.

Output Do4 (clamps 7 and 8): Configurable relay. By default, this output is set as alarm relay (second level variable dO4 = 1).

Relay capacity characteristics:
Do1, Do2, Do3: 16(6)A 250Vac
Do4, Do5: 8(3)A 250Vac

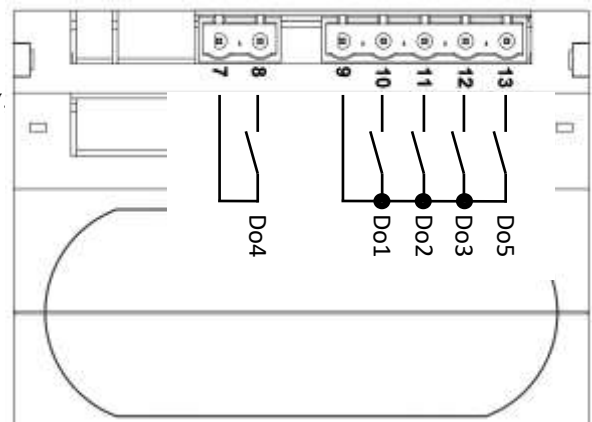

In the ES series humidifiers, outputs Do1, Do2, Do3 and Do5 are already wired.

2.5

TA INPUTS FOR MEASURING CURRENT ABSORPTION

On the electronics of the humidifier there are two inputs from an amperometric transformer, to measure the current of the immersed electrodes:

TA1 (clamps 27 and 28): For the connection of the TA, relative to the cylinder Nr 1

TA2 (clamps 29 and 30): For the connection of the TA, relative to the cylinder Nr 2

2.6

NET CONFIGURATION WITH MODBUS-RTU PROTOCOL

To insert the humidifier in an RS485 network with Modbus-RTU protocol, set the parameter MS = 0 (single humidifier operating mode), and follow the diagram below.

Refer to the MODBUS-RTU_UMIDMS03 manual (available on our website: www.pego.it) for MODBUS-RTU communication protocol specifications.

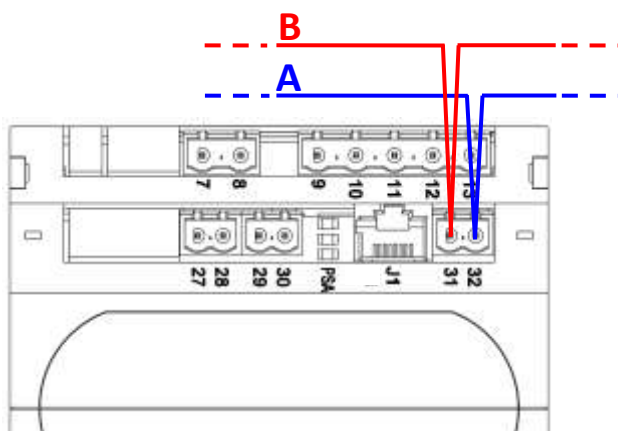

2.7

BOARD POWER SUPPLY

The humidifier electronics require a 230Vac 50-60Hz $\pm 10\%$ power supply and have a maximum consumption of 5VA (only electronic part).

Power supply (clamps 2 and 3): 230Vac 50-60Hz power supply.

2.8

NANO EASYSTEAM DISPLAY FOR MASTER HUM2 ELECTRONIC BOARD

The Master HUM2 electronics is the heart of the humidifier, which can be combined with a NANO EasySTEAM display that allows the display of the machine status, programming and configuration of the parameters. The connection between the display and the Master is made by a cable with an 8-pin RJ45 telephone connector with cross-over connection (supplied together with the display) to be inserted in the two J1 references.

The combined use of Master and display is the most complete and recommended method but not the only one possible; once configured, the Master HUM2 electronics does not require the presence of the display and can be used independently. It is also provided with status LED (see chapter 3.2) and a switch (jumper) for the manual emptying of the cylinder (see chapter 2.5). In this single mode, the alarms are reset by removing power to the electronics.

2.9

ES-OEM-CCU SERIES ELECTRICAL LAYOUTS

Electrical layout model:
400ES3MOEMCCU

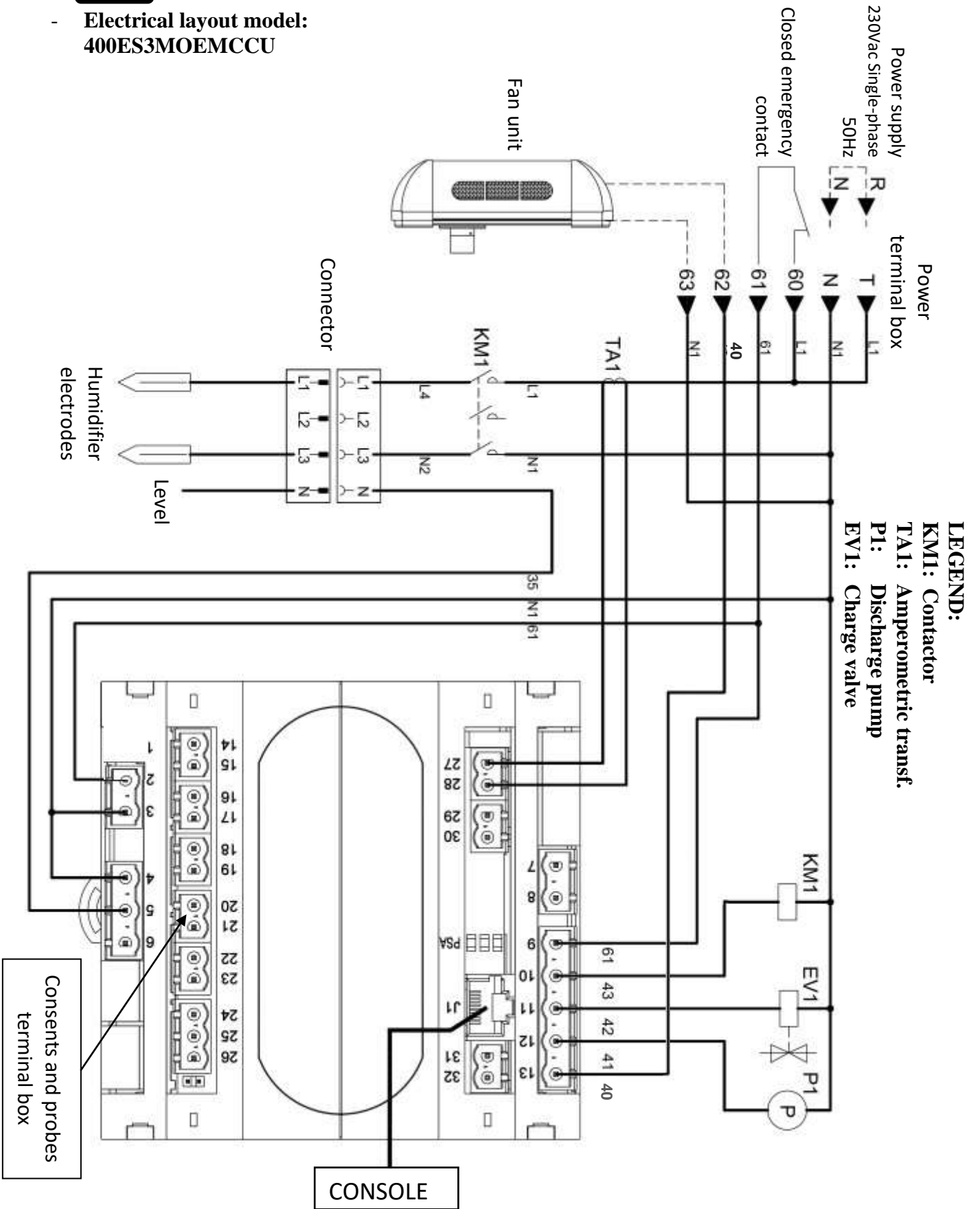

- **Electrical layout model:
400ES6OEMCCU**

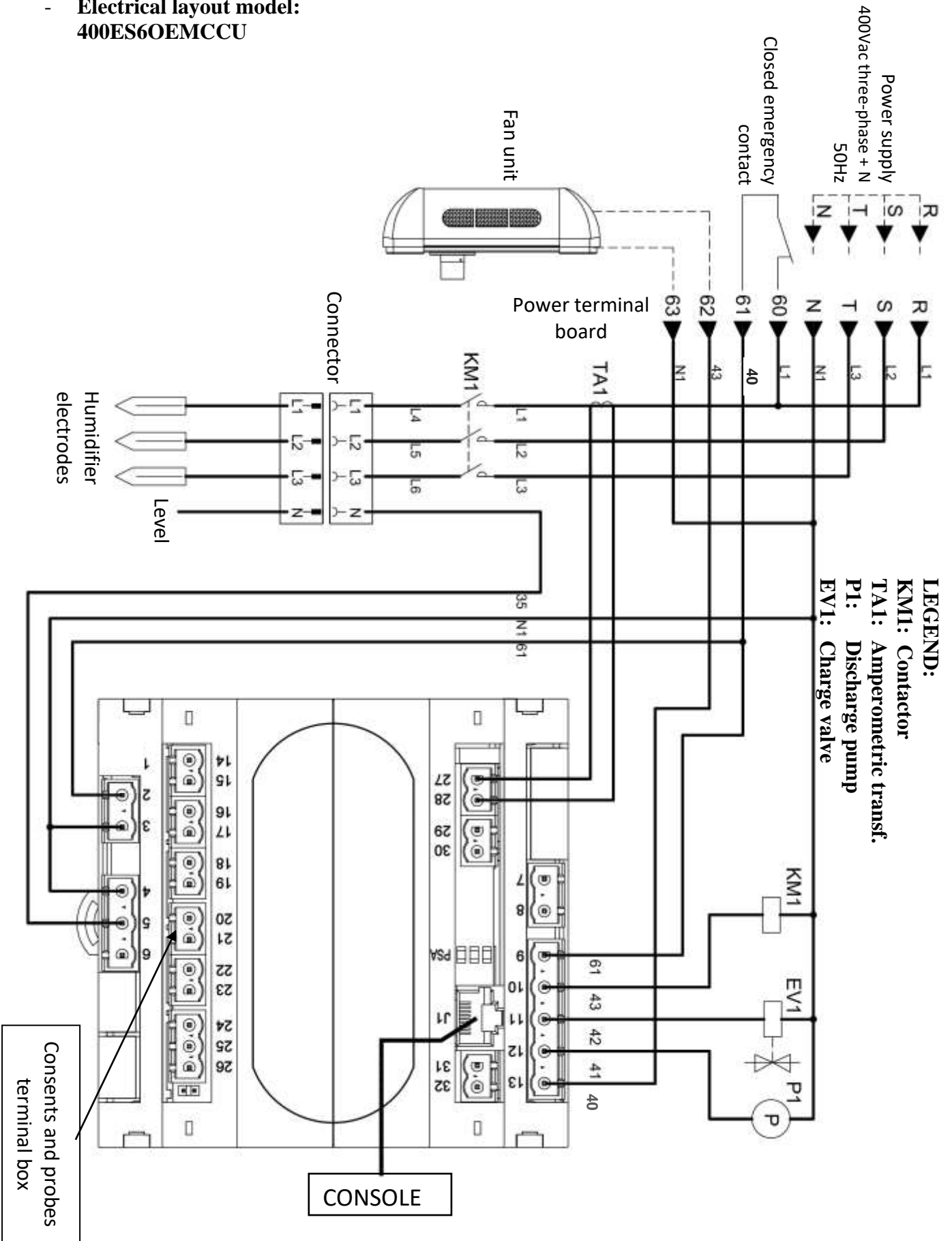

2.10**INSTALLING THE ES-OEMCCU SERIES HUMIDIFIER**

1. Remove the humidifier from its packaging keeping it upright, remove the protective nylon bag and check the integrity of the appliance.
2. By removing the O-ring that holds it to the back, remove the cylinder from the lower flange extracting it upwards and remove it from the humidifier. Fix the humidifier to the wall, possibly at 1 meter from the ground and leveled (fig.1) using the 4 slots at the back to insert the fixing screws (fig. 2). Reassemble the cylinder following the inverse procedure.



Fig. 1



Fig. 2

3. Connect the water discharge tube to the 32mm diameter sleeve, fixing it with the provided clamping band (fig. 3 e 4).

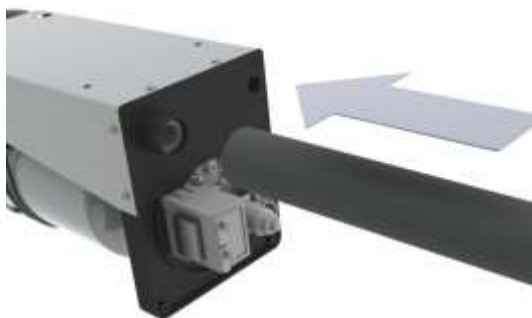

Fig. 3



Fig. 4



Connect a pipe with a diameter of not less than 32mm and suitable for temperatures not less than 100°C, to the drain hose. This pipe must be firmly clamped to the drain sleeve and **have vertical development for at least the first 50cm**. Make sure that you do not create bottlenecks and do not exceed with its height, at any point in the path, the level of the drain sleeve.



NEVER OPERATE THE HUMIDIFIER WITHOUT THE DISCHARGE LINE CORRECTLY CONNECTED!

4. Connect the water supply line to the 3/4 gas connection of the electrovalve located under the humidifier (fig. 5 e 6).



Fig. 5



Fig. 6



Connect the water supply line with a non-metal piping, e.g. rubber, PVC, polypropylene, nylon, etc.

5. Connect the steam tube at the cylinder flange sleeve, fixing it with the provided clamping band (fig. 7 e 8).



Fig. 7



Fig. 8



Use only PEGO HUMIDIFIERS steam tube or other tube with certification that guarantees its use in the presence of high temperatures without internal vulcanization processes and release of harmful substances!



DO NOT MAKE BOTTLENECKS, SIPHONS OR LENGTHS GREATER THAN 5 METERS!



To correctly connect the steam distribution line, carefully read chapter 8, STEAM DISTRIBUTION.

2.11

OEM SERIES POWER SUPPLY ELECTRIC CONNECTIONS



The humidifiers of the ES-OEM-CCU series are characterized by the division into steam unit and electronic kit; connections are the full responsibility of the customer and are described in paragraphs 2.2 - 2.8.

In particular, in section 2.2 there is information for the possible settings, different from the default one.

CHAP. 3 PROGRAMMING

3.1

NANO EASYSTEAM CONTROLLER DESCRIPTION

The NANO EasySTEAM display is normally placed on the front of the humidifier. It consists of a display with 3 digits and 9 luminous icons, for visual control of the magnitudes, and 4 keys for choose the view and modify the settings (fig. 9).

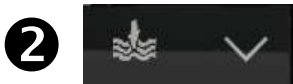

Fig. 9

UP / DISPLAY KEY



- During programming: Increase values / Scroll up the parameters
- During the main display: Selects view between: "absorbed current (A)", "steam production % (%)", "Ambient humidity display (%RH)" or "Ambient temperature display (°C)". Each time it is pressed, it switches to the next display.



DOWN / MANUAL WATER DISCHARGE KEY

- During programming: Decrease values / Scroll down the parameters
- During the main display: Activates the manual water discharge



STAND-BY / SILENCE

- Pressed for more than 2 seconds alternates the Stand-by status to the normal functioning status, and vice-versa. At occurred switching, a confirmation BIP is generated.
- Silences the audible alarm, if in progress / Acquires an alarm

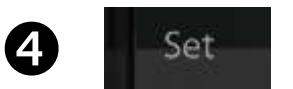

SET (active with S9 = 1, 3, 5, 6, 7, 9)

- When pressed, displays the setpoint and when released "Ambient humidity display (% HR)" or "Ambient temperature display (°C)".
- It allows to set the %HR or °C set point, if pressed together with the Down key or the UP key
- Reset the audible alarm, if in progress.



DISPLAY



STAND-BY ICON

- LED OFF = Humidifier not powered
- LED ON = Humidifier ready for use
- LED Flashing = Humidifier in stand-by



STEAM OUTPUT ICON

- LED ON = Steam production in progress

| | | | |
|----|--|--|---|
| 8 | | ALARM PRESENT ICON | LED OFF = No alarm present LED ON = Maximum level alarm, persistent for more than 1 hour LED Flashing = Alarm present (or maximum level reached) |
| 9 | | TEMPERATURE MEASUREMENT UNITS ICON | LED ON = The display shows the temperature of the ambient probe °C LED Flashing = The display shows the TEMPERATURE SET in °C |
| 10 | | WATER LOAD ICON | LED ON = Water load in progress |
| 11 | | WATER DISCHARGE ICON | LED ON = Water discharge in progress LED Flashing = Water discharge test in progress |
| 12 | | CURRENT MEASUREMENT UNITS ICON (A) | LED ON = The display shows in ampere the instantaneous current absorbed by the humidifier. |
| 13 | | STEAM PRODUCTION % MEASUREMENT UNITS ICON | LED ON = The display shows the percentage production of steam, referred to the nominal one. (Example: for an ES6 that produces 6kg/h of steam, 50% indicates the current production of 3kg/h) |
| 14 | | RELATIVE HUMIDITY MEASUREMENT UNITS ICON | THIS ICON LIGHTS TOGETHER WITH (13) AND "% RH" APPEARS ON THE DISPLAY LED ON = The display shows the percentage of relative humidity of the connected probe LED Flashing = The display shows the percentage relative humidity SET (visible and adjustable by pressing the SET key). |

3.2

COMBINATION OF KEYS

1ST LEVEL PROGRAMMING

If pressed simultaneously for more than 3 seconds, they allow access to the first level programming menu.

At the entry of the menu it is generated a confirmation BEEP.



EXIT FROM PROGRAMMING

If pressed simultaneously for more than 3 seconds in any programming menu, they save the settings by exiting the menu.

At the exit of the menu it is generated a confirmation BEEP.



2ND LEVEL PROGRAMMING

If pressed simultaneously for more than 3 seconds, they allow access to the second level programming menu.

At the entry of the menu it is generated a confirmation BEEP.

STATUS SWITCHING OF THE ESSENCE SUPPLY

(function active only if s9 = 7 or 9 and dO4 or dO5 = 4)

If pressed simultaneously for more than 3 seconds, the current status is displayed (EoF=essence OFF or Eon=essence ON) and continuing to hold them pressed for an additional three seconds, the status switches.



DRYING ACTIVATION

(function active only if s9 = 7 or 9 and dO4 or dO5 = -3 and stand-by active)

If pressed simultaneously for more than 3 seconds, the drying cycle is activated and signalled on display by the writing Uon = outlet fans ON.

To stop this cycle, interrupt the stand-by.



3.3

STATUS LED ON MASTER HUM2 ELECTRONICS

On the Master HUM2 electronics, next to the J1 connector there are three signalling LEDs that allow to know the machine status even in the absence of a display.

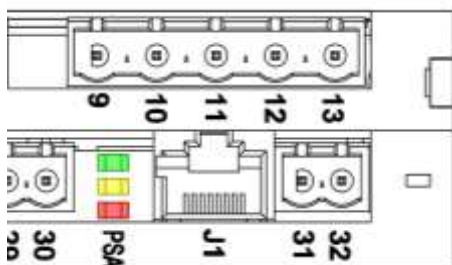
**GREEN LED** initialled P (Power):

Solid: power supply Ok and consent is present.

Flashing: power supply Ok but no consent or stand-by present.

YELLOW LED initialled S (Status):

Solid: Steam production (powered electrodes).

Flashing: Discharge in progress. (0.5 seconds flashes).

RED LED initialled A (Alarm):

When an alarm is present, it is signalled with a sequence of flashes spaced by 0.5 seconds, of a number equal to the error code and with a pause of 2 seconds before repeating the sequence.

3.4

1ST LEVEL PROGRAMMING

1. The 1st level programming enables the user to amend 2 important parameters, the Bp proportional band and the Pr steam production percentage.

| VAR. | MEANING | VALUES | DEFAULT all models |
|------|---|--------------------|-----------------------|
| Pr | Steam production percentage | 20 ÷ 100 % | 100 % |
| Bp | Proportional band (not used in ON/OFF version) | 1 ÷ 20 Rh% | 10 % |
| StC | Max humidity set point in air duct. When the set point is exceeded, the humidifier is set to off and resumes operation when the humidity in the air duct drops below the value StC-r0 with the addition of time t1, according to the logic dictated by the 0-10V signal or from the ambient humidity probe. | 25 ÷ 99 Rh% | 99% |
| r0 | Max humidity set differential in air duct. | 1 ÷ (StC – 20) Rh% | 50% |
| r1 | Temperature differential referred to set point. For temperature values lower than set-r1, the humidifier is activated until the set point is reached (call of heat). If S9=9, r1 is the proportional band. (used only with S9=7 or S9=9 call of heat version) | 0.2 – 10 °C | 2°C |
| UrC | Humidity value read by the humidity probe in air duct | 0-100% | read only |
| PrL | Percentage of steam production during operation with low conductivity (S11=1, Pr is ignored) | 0-100% | read only |



The **Bp** proportional band is the percentage value of the humidity around the set point; within this value the humidifier works proportionally. Example: if the proportional band is set on default value 10% ($\pm 5\%$ set point value) and humidity is set at 50%, below 45% the humidifier will work at 100% of steam production; above 55%, the humidifier will not produce steam. Between 45 and 55%, the humidifier will optimally regulate steam production.

The Pr steam percentage is the value the humidifier can reach at maximum production; leaving setting at 100%, an ES6 with 6kg/h steam production, can reach 6kg/h, if Pr setting is reduced to 50%, the humidifier can produce a maximum of 3kg/h.



The variable **Pr** is very useful in cases of low conductivity of water and to make the most of the cylinder when it is near to replacement; for further information consult chapter 6 DIAGNOSTICS on page 36 of this manual.

The set point of maximum humidity in the duct (stC) limits the humidity in the duct.

If the humidity in the duct is higher than the value set in stC, the humidifier stops the steam production. When the humidity returns below stC-r0, at the end of the delay time t1 (second level variable) the steam production is resumed.

2. To access the first level programming menu, follow the instructions below:

- Press and hold down the UP (\blacktriangle) and DOWN (\blacktriangledown) keys simultaneously for a few seconds until the first programming variable appears on the display.
- Release (\blacktriangle) and (\blacktriangledown) keys.
- Use the (\blacktriangle) key or the (\blacktriangledown) key to select the variable to be modified.
- After selecting the desired variable, it will be possible:
 - Display its settings by pressing the SET key.
 - Change its settings by holding down the SET button and pressing one of the (\blacktriangle) or (\blacktriangledown) keys.

Once you have finished configuring the values, press the keys (\blacktriangle) and (\blacktriangledown) for a few seconds to exit the menu and keep them pressed until the magnitudes displayed before entry into programming reappears, e.g. steam production or absorbed current. The memorization of the changes made to the variables will occur automatically when exiting the configuration menu.

3.5

2ND LEVEL PROGRAMMING

1. The 2nd level programming allows the user to modify various advanced parameters for a specific humidifier setting. It is not recommended to modify these parameters without an indication of the PEGO assistance or a specialized technician.
2. To access the second level programming menu, press and hold down the UP (▲), DOWN (▼) and STANDBY keys simultaneously for a few seconds. When the first programming variable appears, the system automatically switches to stand-by.
 - Use the (▲) key or the (▼) key to select the variable to be modified.
 - After selecting the desired variable, it will be possible:
 - Display its settings by pressing the SET key.
 - Change its settings by holding down the SET button and pressing one of the (▲) or (▼) keys.

Once you have finished configuring the values, press the keys (▲) and (▼) for a few seconds to exit the menu and keep them pressed until the humidity value appears again (appear 0.0 if ON/OFF).

The memorization of the changes made to the variables will occur automatically when exiting the configuration menu.

After exiting the second level programming, press the ON/OFF - STAND-BY key to enable the electronic control (when entering the 2nd level programming, the humidifier automatically switches to STAND-BY mode).

| VAR. | MEANING | VALUES | DEFAULT | |
|-----------|---|-----------------|---------|------|
| | | | ES-3M | ES-6 |
| S0 | Duration of drain pump for deconcentration. | 0.1 ÷ 12.7 s | 2 | 2 |
| S1 | Hours of work | Tenths of hours | - | - |
| S2 | Deconcentration discharging interval. Interval in minutes of work (steam output) for deconcentration discharge. (S2 < 10 alarm E3 is deactivated) | 1 ÷ 250 min | 15 | 15 |
| S3 | Delay time for the activation of the electrodes after any pump discharge. This parameter, if increased, allows in some particular installation situations to eliminate the problem of differential intervention on the power supply line, to the detriment of the speed of return to normal regime after any discharge. | 1 ÷ 12 s | 2 | 2 |
| S4 | Discharge of water for inactivity Full emptying of the cylinder due to inactivity 0 = disabled | 0 ÷ 24 h | 1 | 1 |
| S5 | Minimum current differential between one water load and the next one. | 0.2 ÷ 10 A | 1 | 0,7 |
| S6 | Percentage of overcurrent, referred to the working current to drive the drain pump. | 1 ÷ 50 % | 25 | 25 |
| S7 | Pump discharge duration time for overcurrent. | 0.1 ÷ 5.0 s | 0.5 | 0.5 |
| S8 | Minimum current differential for water load during full or partial cylinder filling. S8=0.0 sets the loading to Step. | 0.0 ÷ 5.0 A | 0.1 | 0.1 |

| VAR. | MEANING | VALUES | DEFAULT | |
|------|---|--------|---------|------|
| | | | ES-3M | ES-6 |
| S9 | <p>Functioning setting set:</p> <p>S9=0 ON-OFF (Enabling ON between clamps 24 and 25)</p> <p>S9=1 (INTEGRATED HUMIDISTAT) PROPORTIONAL WITH 4-20mA PROBE Operation with integrated humidistat. 4-20mA ambient humidity probe connected to analogical input no. 1 (clamps 14-15).</p> <p>S9=2 PROPORTIONAL REFERRED TO 0-10V EXTERNAL SIGNAL 0-10V reference signal connected to analog input no.2 (clamps 16-17).</p> <p>S9=3 (INTEGRATED HUMIDISTAT) PROPORTIONAL WITH 4-20mA PROBE AND 4-20mA PROBE IN AIR DUCT 4-20mA ambient humidity probe connected to the analogue input no.1 (clamps 14-15). 4-20mA humidity probe in air duct connected to the analogue input no.4 (clamps 21-22).</p> <p>S9=4 PROPORTIONAL REFERRED TO 0-10V SIGNAL AND 4-20mA PROBE IN AIR DUCT 0-10V reference signal connected to analog input no.2 (clamps 16-17). 4-20mA humidity probe in air duct connected to the analogue input no.4 (clamps 21-22).</p> <p>S9=5 (INTEGRATED HUMIDISTAT) PROPORTIONAL WITH 0-10V PROBE 0-10V ambient humidity probe connected to the analogue input no.2 (clamps 16-17).</p> <p>S9=6 (INTEGRATED HUMIDISTAT) PROPORTIONAL WITH 0-10V PROBE AND 0-10V PROBE IN AIR DUCT 0-10V ambient humidity probe connected to the analogue input no.2 (clamps 16-17). 0-10V humidity probe in air duct connected to the analogue input no.5 (clamps 22-23).</p> <p>S9=7 (INTEGRATED THERMOSTAT) Operation with integrated thermostat (call of heat ON/OFF) and NTC temperature probe connected to the analogue input no.3 (clamps 18-19).</p> <p>S9=8 PROPORTIONAL REFERRED TO VALUE SENT ON RS485 (0-100%) Steam production request reference (0-100%) from RS485 line (Modbus). To set steam production, use register 1537. N.B. – The commands to force water discharge and produce steam have a time-out of 1 minute; if during this period the command is not sent again on Modbus, at the end of this time the steam production will be set to zero and the drain pump will be disabled. This secures the humidifier in case of accidental disconnection of the communication network.</p> <p>S9=9 (INTEGRATED THERMOSTAT) PROPORTIONAL WITH NTC PROBE Operation with integrated thermostat. NTC temperature probe connected to the analog input no.3 (clamps 18-19).</p> <p>Attention: the enabling between clamps 24 and 25 must be given for any type of selected functioning.</p> | 0 ÷ 9 | 0 | 0 |

| VAR. | MEANING | VALUES | DEFAULT | |
|------------|--|---|---------|--------|
| | | | ES-3M | ES-6 |
| S10 | Water discharge Test | 0 = Disabled 1 = Enabled | 1 | 1 |
| S11 | Low conductivity operation (see Chap. 5.3) | 0 = Disabled 1 = Enabled | 0 | 0 |
| S12 | Maximum activation time of the drain pump. Discharges are made in steps of S12 seconds, with pauses of 5 seconds. This function is used in case there is a water discharge tube of inadequate dimensions. | 0 ÷ 50 sec 0 = continuous | 0 | 0 |
| CA1 | Humidity probe calibration (used when S9 = 1, 3, 5, 6) | -20 % ÷ 20 % | 0 % | 0 % |
| CA2 | Air duct humidity probe calibration (used when S9 = 3, 4, 6) | -20 % ÷ 20 % | 0 % | 0 % |
| CA3 | NTC probe value correction (used when S9 = 7, 9) | -10,0 ÷ 10,0 °C | 0,0 | 0,0 |
| t1 | Delay in seconds to restart the humidifier. The delay starts from the moment when the humidity in the air duct, after passing StC, has returned below StC-r0. Only after this delay the normal functioning will be resumed (used when S9 = 3, 4, 6). | 0 ÷ 240 s | 10 s | 10 s |
| t2 | Operating time ON for the essence. If steam production is in progress and the temperature is higher than 70% of the SET set-point, the configured relay calls the essence for time t2 and waits for the time t3 between one call and another (used only when S9 = 7 or 9). | 1 ÷ 30 s | 2 s | 2 s |
| t3 | Operating time OFF for essence. If steam production is in progress and the temperature is higher than 70% of the SET set-point, the configured relay calls the essence for time t2 and waits for the time t3 between one call and another. With t3 = 0 there is the continuous call of the essence if the above conditions are satisfied (used only when S9 = 7 or 9). | 0 ÷ 99 min | 5 min | 5 min |
| t4 | Timer for manual insertion of outlet fans. Function that can be activated manually with the key combination down arrow + Stand-by and active only with S9 = 7, 9 and dO4 or dO5 = -3 and humidifier in stand-by. At the end of the day, once the system is put on stand-by, it is possible to operate the outlet fans for a certain period to dry the room. | 0 ÷ 24 hours 0 = Disabled | 0 | 0 |
| t5 | Activation time for the E9 Serious Alarm. When the E8 alarm remains permanently for more than a time t5, the E9 serious alarm is activated. The E9 alarm is activated even if in a period of 12 hours occur 3 E8 alarm situations. The E9 alarm is disabled with t5=0. | 0 ÷ 99 min 0 = Disabled | 15 min | 15 min |
| t6 | Inlet fan activation time. The relay configured for the inlet fan remains energized for a time t6 after the steam production has been switched off. This ensures the extraction of the steam from the cylinder and prevents the formation of condensation in the eventual fan unit. t6 = -1: continuous operation (even in stand-by or alarm) | 0 ÷ 60 min -1 = continuous operation | 20 min | 20 min |
| CL1 | Cleaning mode – Duration of the cleaning function (can only be activated with S9 = 0 / 7 / 9) If CL1 > 0, the humidifier remains active for CL1 minutes, then returns to stand-by. For more details on the cleaning function see Chapter 2.4. | 0 ÷ 60 min 0 = Disabled | 0 | 0 |
| CL2 | Cleaning mode – Percentage of steam production for the cleaning function (used only with S9 = 0 / 7 / 9) If CL1 > 0, the humidifier remains active for CL1 minutes, then returns to stand-by. For more details on the cleaning function see Chapter 2.4. | 10 ÷ 100% | 80% | 80% |

| VAR. | MEANING | VALUES | DEFAULT | |
|------------|--|--|---------|------|
| | | | ES-3M | ES-6 |
| In1 | <p>Setting of the digital input In1 and its activation status.</p> <p>±10 = drive of the drain pump ±9 = reduced operation to 90% ±8 = reduced operation to 80% ±7 = reduced operation to 70% ±6 = reduced operation to 60% ±5 = reduced operation to 50% ±4 = reduced operation to 40% ±3 = reduced operation to 30% ±2 = Enabling (in series to possible In2 and In3 enabling) ±1 = alarm input 0 = disabled</p> <p>“+” for active input with closed contact “-“ for active input with open contact</p> | -10 ÷ 10 | 2 | 2 |
| In2 | <p>Setting of the digital input In2 and its activation status. See In1 options</p> | -10 ÷ 10 | 10 | 10 |
| In3 | <p>Setting the VOLTAGE input In3 and its activation status. See In1 options</p> | -10 ÷ 10 | 0 | 0 |
| dO4 | <p>Setting the functions of the digital output dO4. The less sign indicates the reverse status of the relay. With the exception of settings 1, -1, 2, -2, the relay is deactivated in case of no enabling or it is in stand-by.</p> <p>4 = Relay excited for essence call 3 = Inlet fan relay (activated with steam production request) 2 = Relay activated when the appliance is in stand-by or for absence of consent. 1 = Relay activated in presence of an alarm 0 = Relay Disabled -1 = Relay deactivated in presence of an alarm -2 = Relay deactivated when the appliance is in stand-by or for absence of consent. -3 = Outlet fan relay (deactivated with steam production request)</p> | -3 ÷ 4 | 1 | 1 |
| dO5 | <p>Setting the functions of the digital output dO5. The less sign indicates the reverse status of the relay. With the exception of settings 1, -1, 2, -2, the relay is deactivated in case of no enabling or it is in stand-by.</p> <p>4 = Relay excited for essence call 3 = Inlet fan relay (activated with steam production request) 2 = Relay activated when the appliance is in stand-by or for absence of consent. 1 = Relay activated in presence of an alarm 0 = Relay Disabled -1 = Relay deactivated in presence of an alarm -2 = Relay deactivated when the appliance is in stand-by or for absence of consent. -3 = Outlet fan relay (deactivated with steam production request)</p> | -3 ÷ 4 | 3 | 3 |
| HSE | Maximum value attributable to set point | 0 ÷ 99 | 99 | 99 |
| BEE | Buzzer enable | 0 = disable 1 = enable | 1 | 1 |
| Ad | <p>Network address for connection to the Modbus-RTU supervision system or for the master-slave configuration. Note: In Master mode, you can assign address 0.</p> | 1 ÷ 247 if MS ≤ 1 0 ÷ 247 if MS > 1 | 1 | 1 |

| VAR. | MEANING | VALUES | DEFAULT | |
|------------|--|-----------|---------|------|
| | | | ES-3M | ES-6 |
| MS | <p>Setting the Master-Slave operating mode. (with MS=0 Modbus is enabled)</p> <p>0 = Single 4 = Master + 3 slaves 1 = Slave 5 = Master + 4 slaves 2 = Master + 1 slave 6 = Master + 5 slaves 3 = Master + 2 slaves</p> | 0 ÷ 6 | 0 | 0 |
| Bdr | <p>Modbus baudrate < Range: 0 ÷ 8 ></p> <p>0 = 300 baud 3 = 2400 baud 6 = 14400 baud 1 = 600 baud 4 = 4800 baud 7 = 19200 baud 2 = 1200 baud 5 = 9600 baud 8 = 38400 baud</p> | 0 ÷ 8 | 5 | 5 |
| Prt | <p>Configuration of the Modbus parity check. < Range: 0 ÷ 2 ></p> <p>0 = No parity 1 = Even parity 2 = Odd parity</p> | 0 ÷ 2 | 0 | 0 |
| P1 | <p>Password: type of protection (active when PA is different from 0) < Range: 0 ÷ 2 ></p> <p>0 = it only displays the set point and allows to silence the alarms 1 = blocks access in 1st and 2nd level programming (all other functions are allowed) 2 = blocks access in 2nd level programming (all other functions are allowed).</p> | 0 ÷ 2 | 2 | 2 |
| PA | <p>Password (see P1 for the type of protection) < Range: 0 ÷ 999 / 0 = Disabled ></p> | 0 ÷ 999 | 0 | 0 |
| rEL | MASTER software release | read only | 19 | 19 |

CHAP. 4 MASTER/SLAVE CONFIGURATION

4.1

SINGLE HUMIDIFIER CONFIGURATION (default configuration)

The humidifier is set as "single" (MS=0) and works autonomously according to the setting assigned in variable S9.

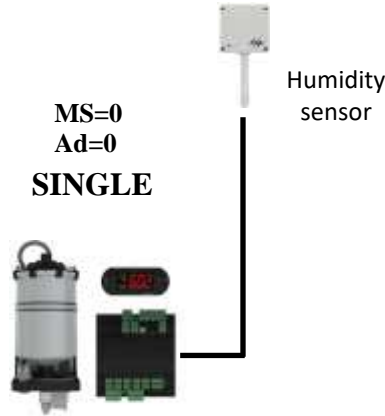

4.2

MASTER/SLAVE HUMIDIFIERS CONFIGURATION

In this configuration, the humidifiers (up to a maximum of 6 units) function as if they were one machine, producing steam according to the common reference given by the Master unit. The Master also manages the precedence of the deconcentration discharges or tests of the various humidifiers (including its own) with a FIFO (a single deconcentration discharge at a time) thus ensuring continuity in steam production.

Connections between master and slave:

The humidifier configured as master communicates with the various slave humidifiers by means of a RS-485 serial connection between the various Master HUM2 electronics.

The maximum connection length is not defined but depends on the quality of the cable and the signal/noise ratio. It is set indicatively at 500 meters.

The connection cable can be unshielded if the distance is a few meters in an electrically little "noisy" place. For distances between 15 and 100 meters it is possible to use a shielded and twisted cable without particular characteristics, while for connections over 100m it is advisable to use for example a **BELDEN 8762** cable.

The communication line must be of a chain type, avoiding star configurations.

The shield of the cable used must be connected to the ground on one side.

Avoid placing the RS-485 serial connection in the same conduits (or tubes) of the power cables.

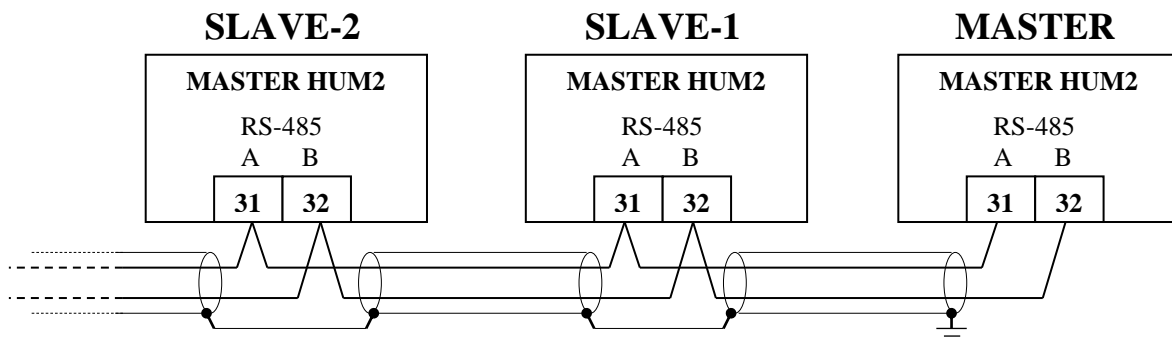

Master/Slave address:

The setting of the **MS** and **Ad** parameters of the various units, in this configuration is fixed and follows these rules:

Parameters configuration in Master unit:

| | | |
|------|---|--|
| Ad = | 0 | Control Master Address |
| MS= | 2 | with Control Master + Slave1 |
| | 3 | with Control Master + Slave1+Slave2 |
| | 4 | with Control Master + Slave1+Slave2+Slave3 |
| | 5 | with Control Master + Slave1+Slave2+Slave3+Slave4 |
| | 6 | with Control Master + Slave1+Slave2+Slave3+Slave4+Slave5 |

Parameters configuration in Slave1 unit:

| | | |
|------|---|----------------|
| Ad = | 1 | (Ad Master +1) |
| MS= | 1 | slave |

Parameters configuration in Slave2 unit:

| | | |
|------|---|----------------|
| Ad = | 2 | (Ad Master +2) |
| MS= | 1 | slave |

Parameters configuration in Slave3 unit:

| | | |
|------|---|----------------|
| Ad = | 3 | (Ad Master +3) |
| MS= | 1 | slave |

Parameters configuration in Slave4 unit:

| | | |
|------|---|----------------|
| Ad = | 4 | (Ad Master +4) |
| MS= | 1 | slave |

Parameters configuration in Slave5 unit:

| | | |
|------|---|----------------|
| Ad = | 5 | (Ad Master +5) |
| MS= | 1 | slave |

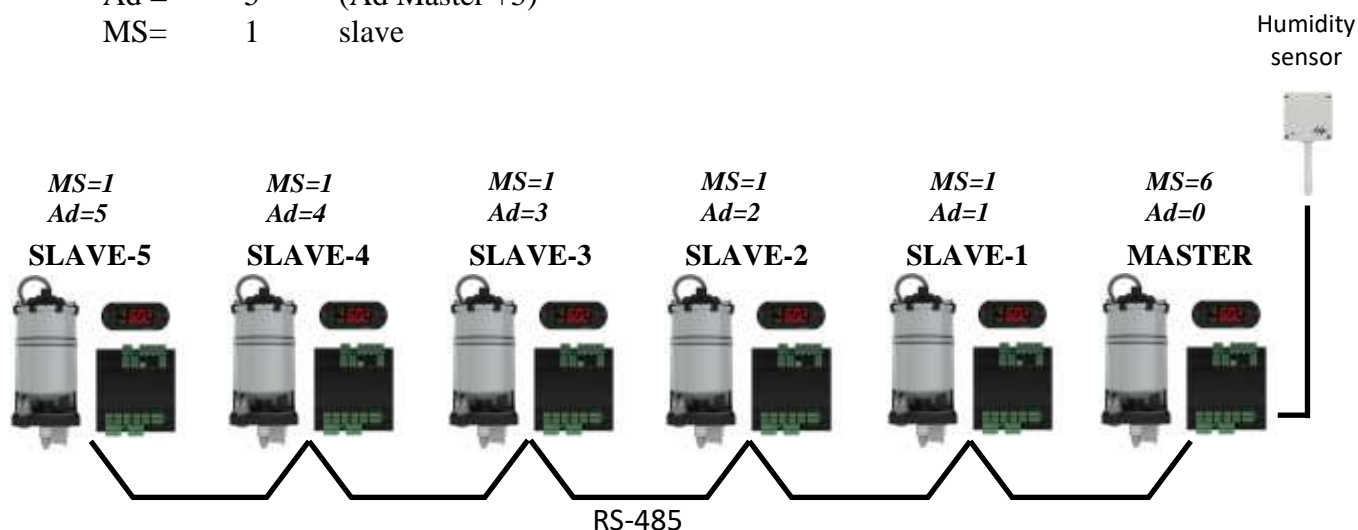

Description of operation:

The unit configured as Master constantly communicates with the connected slaves through the RS-485 connection, indicating the quantity of steam to be produced (0-100%) and managing the priorities of the various units in relation to discharges for deconcentration or testing.

The operating mode of the Master/Slave unit is only set on the Master by means of the variable S9, as well as the possible connection of the ambient humidity probe, the humidity probe in the duct, the 0-10V reference signal, the ON-OFF enablement and the humidity setting.

The variable Pr, which represents the percentage of steam production at full capacity, is instead set on each individual unit.

The absence of consent (clamps 24 and 25 open on Master HUM2 board) behaves as follows:

- On the Master unit, it stops the same Master unit and all the connected slave units (flashing OFF).
- On the Slave units, stop only the slave unit concerned (OFF flashing).

Stand-by by means of the dedicated key behaves as follows:

- If activated on the Master unit, it puts the machine in stand-by mode (LED flashes on the stand-by key) and brings the steam production request of the connected slaves to zero.
- On the Slave units, it stops only the concerned slave unit by putting the machine in stand-by mode (LED flashes on the stand-by key).

If the Master cannot communicate with a slave, after a 15-second timeout time it signals the problem with an alarm that can be silenced (E7). The interrogation of the slave continues and if the communication resumes, the error is reset automatically.

If a Slave is not queried by the Master within a timeout period of 15 seconds, it considers interrupted the connection and therefore leads to 0 the production of steam, disconnecting the electrodes and signalling the anomaly with an alarm that can be silenced (E7). If the connection is resumed, the alarm is reset automatically and normal operation is resumed.

On the humidifiers configured as Slaves (MS = 1), the variable S9 is not considered; for them the production of steam follows in a proportional way the data sent by the Master on the RS485 connection.

Management of priorities of discharges for deconcentration and tests:

The priorities for deconcentration discharges and for diagnostic tests are managed as follows:

The Slave units, when interrogated, send the eventual water discharge request to the Master that manages them with a FIFO (first input / first output).

The Master waits 3 minutes before giving the next consent to the waiting unit, following the priority in the FIFO; this allows the unit that is discharging the water to resume steam production.

The Slave unit that requested a discharge waits for the consent from the Master for 45 minutes, after which it is executed anyway (Time out).

CHAP. 5 IGNITING THE HUMIDIFIER

5.1

FIRST IGNITION



1. Verify that the default setting is compatible with the signal connection made; if different, configure the electronics correctly before powering up as described in chapter 2.
2. Before connecting the humidifier, check the correct connection of the phases and of the type of input signals; check also the correct connection of the mains water, the water drain and the steam tube.



If the mains water connection line has been made with pipes that may contain oily residues or other substances that generate foam, it is essential to wash it by letting the water run for a few minutes.

3. Check that there are no water leaks inside the humidifier.
4. Give power supply to the humidifier.
5. The humidifier will run a water drain for a few seconds, emitting a long beep.
6. The humidifier is now in STAND-BY mode. To switch it on, press the ON/OFF – STAND-BY key: the humidifier will display the humidity value measured by the probe, if configured in 4-20mA PROPORTIONAL mode, or it will display the current consumption, if configured in ON/OFF and 0-10V PROPORTIONAL mode.
7. The humidifier to work requires the digital input 1 to be enabled by means of a voltage free contact (terminals 24 and 25 on the electronic board MasterHUM2) regardless of the selected operating mode and if the parameter In1 = ± 2. When not enabled, the display alternates the word OFF to the normal display.

5.2

STEAM PRODUCTION



1. Set the required humidity value by pressing the SET key and increasing the value with the UP key, in the 4-20mA PROPORTIONAL models (if the set value is higher than that measured by the probe, steam production begins); or give ON/OFF or 0-10V consent in the ON/OFF or PROPORTIONAL 0-10V models.
2. Allow the cylinder to fill up until the water starts boiling, then completely empty the cylinder with the MANUAL DRAIN key to start the pump. Repeat the operation 1-2 times.
3. Now the humidifier is operational and can function properly in a completely autonomous way.

5.3

SMART PRODUCTION FOR LOW CONDUCTIVITY

Smart production function with low conductivity water.

Set parameter S11=1 if all the following conditions are true:

- the requested percentage of steam production Pr was not reached;
- at start-up, the cylinder fills up completely and triggers the level sensor;
- the current measured with a cylinder full of water is greater than 0.5A, but it is not sufficient to guarantee the required steam production.

With the "Smart production for low conductivity" function activated, the humidifier automatically regulates the percentage of steam production based on the conductivity of the water. If the water is not sufficiently conductive at the first start, the percentage of steam production is reduced to avoid reaching the level sensor and the consequent blocking of the machine. **The humidifier will not work immediately according to the steam production percentage set with parameter Pr, but the purpose of the procedure is to reach it gradually.** When the function is active, the value of the calculated steam request can be displayed in the PrL parameter (first level of programming).

The Smart production for low conductivity function only modifies the percentage of steam production. In the case of water with extremely low conductivity, it is advisable to modify the following parameters:

S2 Deconcentration discharging interval: set **30 ÷ 50 min**

S4 Discharge of water for inactivity: set **0**

S8 Set = **0** to activate step water loading

CHAP. 6 DIAGNOSTICS

The EASYSTEAM humidifier in case of anomalies warns the operator through alarm codes and visual and acoustic signalling.

When an alarm condition occurs, the display icon is activated, the alarm relay is activated (if configured), the internal buzzer is activated and one of the following alarm codes is displayed.



At any time, by pressing the "silence" key it is possible to inhibit the internal buzzer. Pressing the SET key resets the acoustic signalling.

Alarms can be of three types, depending on their severity:

- With automatic reset (the alarm is reset automatically when the problem disappears).
- With manual reset from keyboard (the alarm is reset automatically).
- With manual reset by removing power supply to the board (serious alarm that cannot be silenced).

Without the console it is possible to identify the type of alarm present by counting the flashes of the red LED on the Master (e.g. for E3 there are 3 flashes followed by a long pause. Instead, the E0 alarm is signalled with the permanent lighting of the red LED on the Master).

To reset an alarm without automatic reset, in the absence of the display, switch off the power supply to the electronics. The Do4 output (clamps 7 and 8) is set by default as an alarm relay (second level variable dO4=1).

| CODE | POSSIBLE CAUSE/DESCRIPTION | OPERATION TO BE PERFORMED | RESET |
|--|--|---|-----------|
| OFF flashing | The enabling consent is absent | On the Master HUM2 check the enabling consent on clamps 24 and 25 and the configuration of eventual additional consents of the digital inputs. | automatic |
|  flashing without any alarm code | Maximum water level in the cylinder. The water inside the cylinder has reached the maximum level sensor and the absorbed current is within a permitted range (> 0.5A). (during this alarm there is no acoustic signalling) At the beginning of a steam production cycle, if the water inside the cylinder reaches the maximum level sensor, the cylinder is emptied completely to try to eliminate the presence of foam (anti-foam cycle) and then starts again with steam production. After the anti-foam cycle, if the level is still reached, the water load is blocked and steam continues to be produced. | Particles in suspension produced by oils or greases present in the water loading line may cause foaming that activates the level sensor: perform some complete washes of the cylinder with manual water discharge, immediately after the full load. A water conductivity above 1300µS/cm may cause foaming: increase the frequency of deconcentration discharges by modifying parameter S2. Check that there is no water under the cable-carrier circular tube, on the top of the cylinder. This, if present, could penetrate the circular tube and create a false contact on the level sensor: dry everything carefully. | automatic |
|  permanent without any alarm code | Permanence of the maximum level of water in the cylinder. The maximum water level sensor in the cylinder has been activated continuously for more than one hour, after an anti-foam cycle. This alarm blocks the production of steam until it is acquired (pressing the Silence key). | Use the same operations as indicated for the "Maximum water level in the cylinder". | manual |
| En | No connection between the NANO EasySTEAM display and the Master HUM2 electronics | Check connection on J1 connector and of connection cable. | automatic |

| | | | |
|---|---|---|-----------|
| EE | <p>EEPROM ALARM An error has been detected in the EEPROM memory (the outputs are all disabled, except for alarms)</p> | <ul style="list-style-type: none"> • Switch the appliance off and on again. • If the problem persists, contact the technical assistance service. | manual |
| E0 | <p>Functional anomaly of the ambient probe, set in the variable S9.</p> | <p>Verify the correct configuration of the used probe (variable S9 and electrical connections on dedicated clamps). If the problem persists, replace the probe.</p> | automatic |
| E1 | <p>Maximum level of water in the cylinder / Problems of current reading.</p> <p>The water inside the cylinder has reached the maximum level sensor and the absorbed current is below the minimum threshold of 0.5A.</p> <p>The achievement of the maximum level combined with a current measured too low, identifies an anomaly that does not occur in normal operation.</p> <p>This alarm blocks the production of steam until it is acquired (pressing the Silence key).</p> | <p>Check the correct insertion of the cylinder connector to the humidifier.</p> <p>Using an amperometric clamp, check the absorption on the supply phases: one of the phases may be interrupted.</p> <p>Check the deterioration of the cylinder electrodes.</p> <p>Check that the conductivity of the water is above the minimum allowed for the type of cylinder used; in particular, for normal cylinders it must be greater than 250µS/cm and for cylinders with low conductivity it must be greater than 125µS/cm. If so, try reducing the steam production % by modifying the Pr variable to lower the water working level in the cylinder.</p> <p>Particles in suspension produced by oils or greases present in the water loading line may cause foaming that activates the level sensor: perform some complete washes of the cylinder with manual water discharge, immediately after the full load.</p> <p>A water conductivity above 1300µS/cm may cause foaming: increase the frequency of deconcentration discharges by modifying parameter S2.</p> <p>Check that there is no water under the circular cable tray, on the top of the cylinder. This, if present, could penetrate the circular cable tray and create a false contact on the level sensor: dry everything carefully.</p> | manual |
| E1 +  flashing | <p>Pump discharge test anomaly (Skipped 5 consecutive tests).</p> <p>During a pump discharge test (performed once every 10 hours of operation) if the maximum level is reached or the test current It isn't reached within 10 minutes, the test is interrupted and considered SKIPPED.</p> <p>After the consecutive skip of 5 tests the error E1 is activated and the steam production is blocked until the alarm is acquired (pressing the Silence key).</p> | <p>Use the same operations as indicated for the E1 error described above.</p> | manual |
| E2 | <p>Functional anomaly of the humidity probe in air duct, set in variable S9.</p> | <p>Verify the correct configuration of the used probe (variable S9 and electrical connections on dedicated clamps). If the problem persists, replace the probe.</p> | automatic |
| E3 | <p>Lack of water for a prolonged time.</p> <p>When $S2 \geq 10$ and the water loading solenoid valve remains active for a time equal to (S2 minus 1 minute), the alarm E3 is activated.</p> <p>If $S2 < 10$ the alarm E3 is deactivated.</p> <p>This alarm blocks steam production.</p> <p>To reset the alarm, you need to enter and exit the stand-by.</p> | <p>Check that the mains water line is active.</p> <p>Verify that there is no water leak due to a break.</p> <p>Verify that the water loading solenoid valve is not faulty or disconnected.</p> | manual |

| | | | |
|------------------|--|---|------------------|
| <p>E5</p> | <p>Water discharge auto-test, failed (Pre-alarm) This alarm does not block the steam production. However, it is necessary to eliminate the cause of the problem before the next test, which is performed every 10 hours of operation of the electrodes, to avoid incurring the error E6 which instead blocks the steam production. The alarm is automatically reset at the next discharge test, if no longer in progress, or when the humidifier is switched off.</p> | <p>Check that the water discharge tube and the bottom of the cylinder are not obstructed and that the pump is not faulty or disconnected. If this test is not considered necessary, it can be disabled by taking the variable S10=0</p> | <p>automatic</p> |
| <p>E6</p> | <p>Water discharge auto-test failed for the second consecutive time. This alarm blocks steam production to prevent damage to the appliance and cannot be silenced. To reset the alarm, the humidifier must be switched off.</p> | <p>Check that the water discharge tube and the bottom of the cylinder are not obstructed and that the pump is not faulty or disconnected. If this test is not considered necessary, it can be disabled by taking the variable S10=0</p> | <p>manual</p> |
| <p>E7</p> | <p>In a Master/slave humidifier configuration, the Master cannot communicate with a slave connected to it. This alarm does not block normal operation and when the connection is restored the alarm is automatically reset.</p> | <p>Check the connections between the master and slave units. Check the second level parameters MS and Ad, related to the Master/slave configuration.</p> | <p>automatic</p> |
| <p>E7</p> | <p>In a Master/slave humidifier configuration, the slave unit has lost communication. This alarm blocks the unit, but when the connection is restored, the alarm is automatically reset.</p> | <p>Check the connections between the master and slave units. Check the second level parameters MS and Ad, related to the Master/slave configuration.</p> | <p>automatic</p> |
| <p>E8</p> | <p>Alarm from digital input (usually safety thermostat). This alarm starts if one of digital inputs configured as alarm persists for more than 5 seconds. It blocks the steam production and activates the acoustic signalling (it can be silenced). The alarm is automatically reset when the alarm input disappears.</p> | <p>Check the alarm input. (usually safety thermostat)</p> | <p>automatic</p> |
| <p>E9</p> | <p>SERIOUS alarm from digital input (usually safety thermostat). If the E8 alarm remains continuously for a time greater than t5, the serious alarm E9 is activated. The E9 alarm takes over even if three E8 alarm situations occur within 12 hours. It blocks steam production to prevent damage to the appliance and cannot be silenced. Alarm E9 is disabled with t5=0. To reset the alarm, the humidifier must be switched off.</p> | <p>Check the alarm input. (usually safety thermostat)</p> | <p>manual</p> |
| <p>E9</p> | <p>The differential protection upstream of the humidifier supply line has intervened. Water present in lower part of humidifier due to a fault or after maintenance causing unit dispersion towards the ground.</p> | <p>Bring unit in safe conditions following instructions in chapter 7.2. Carefully dry all the wet parts and reactivate the unit.</p> | <p></p> |
| <p>E9</p> | <p>Humidifier produces insufficient steam.</p> | <p>One of the phases could be interrupted. Check the current absorption on all phases. Check that there is no obstruction of the steam tube caused by a build-up of condensation. The steam tube must not have any siphons (see chapter 8).</p> | <p></p> |

CHAP. 7 MAINTENANCE

7.1

MAINTENANCE

To guarantee operational safety, correct operation and optimal performance of the EASYSTEAM series humidifiers, regular maintenance must be carried out according to the instructions below.

7.2

GENERAL AND SAFETY STANDARDS



Whatever the type of maintenance, it must only be carried out by expert and qualified technical personnel, aware of the necessary safety precautions.

Before starting any maintenance operation, proceed as follows:

1. If the unit is out of service for an alarm condition, make a note of the error code shown on the display.
2. Close the shut-off valve on the water supply line.
3. Bring the humidifier into stand-by, using the appropriate key, and completely drain the water contained in the cylinder by pressing the manual drain key on the front of the NANO Display (see chapter 3).
4. Disconnect the unit from the mains, using the upstream power switch and padlocking it to OFF.
5. Wait until the cylinder and the humidifier have cooled down or use protective gloves.
6. Each item of the appliance, in case it should be faulty or damaged, must be replaced only with original parts.

7.3

MAINTENANCE INTERVALS

The following are the maintenance operations to be performed and their suggested frequency.

However, since the consumption of the electrodes and the formation of limescale and solid deposits inside the cylinder vary according to the type of water (even with the same conductivity), more frequent maintenance may be necessary.

Check this need by checking the amount of deposits inside the cylinder: a fast accumulation of limescale and deposits requires an increase in the suggested maintenance frequency and/or the variation of the parameters related to the deconcentration discharges.



To minimize the formation of deposits on the bottom of the cylinder it is advisable to increase the frequency of deconcentration discharges, reducing the value of the **S2** variable. However, this measure has the disadvantage of determining a greater consumption of water and energy.

| MAINTENANCE OPERATIONS TO BE PERFORMED | FREQUENCY |
|--|---|
| Check the absence of water leaks inside the humidifier. | After 1 hour of functioning |
| Check the tightening of the electrical connections. | After 4 weeks of functioning |
| Check the absence of water leaks inside the humidifier. Check the condition of the cylinder and remove any deposits or limescale if present inside. Replace the cylinder, if necessary. | Monthly or every 500 hours of functioning |
| Check the wear of the cylinder electrodes and the absence of deformations or blackening on their surface; replace the cylinder in case of wear or obvious defects. | Every three months or every 1000 hours of functioning |
| Replace the cylinder. Check the tightening of the electrical connections and the good condition of water and steam connections. | Annually or every 2500 hours of functioning |
| Check for water leaks inside the humidifier. Check cylinder status: check the wear of the electrodes and remove any deposits or limescale if present inside. Replace the cylinder, if necessary. | When the E1 alarm code occurs |
| Check the absence of water leaks inside the humidifier. Verify that the water loading solenoid valve is not disconnected or faulty; if so, replace it. | When the E3 alarm code occurs |
| Verify that the discharge pump is not disconnected or faulty: if so, replace it. If present, eliminate any blockages on the bottom of the cylinder and in the water discharge tube. | When the E5 or E6 alarm code occurs |

7.4

REPLACEMENT OF THE CYLINDER



The only consumable item of the humidifier is the cylinder, when the electrodes are worn due to functioning or it's not possible to eliminate all the limestone deposit formed within. The ES-OEM-CCU series is provided with steel electrodes for longer duration that, however, depends on the amount of water (level of conductivity and hardness) and work output to which the humidifier is submitted.

When the electrodes are worn making cylinder replacement necessary, the water level rises anomalously compared to optimal functioning, repeatedly triggering the maximum level alarm **E1**. Now having checked the alarm is not caused by other anomalies (see chapter 6 Diagnostics), carry out replacement as indicated below:



NEVER REPLACE THE CYLINDER WITH THE MACHINE HOT AND WITH WATER INSIDE. BEFORE PERFORMING THE REPLACING, EMPTY COMPLETELY THE CYLINDER USING THE MANUAL DISCHARGE KEY! IT IS COMPULSORY TO FOLLOW THE PRESCRIPTIONS INDICATED IN CHAPTER 7.2

1. Loosen the steam pipe clamp and disconnect the hose. (Fig. 10)
2. Using a screwdriver, remove the protective caps on the electrodes (3, 4 or 6 protective caps according to the model). (Fig. 11)
3. With a 10mm wrench, disconnect the electrodes supply cables and the level sensor by pulling it upwards. (Fig. 11)
4. Unhook the retaining O-ring and slightly rotate the cylinder by pulling it upwards. (Fig. 12)



Fig. 10



Fig. 11

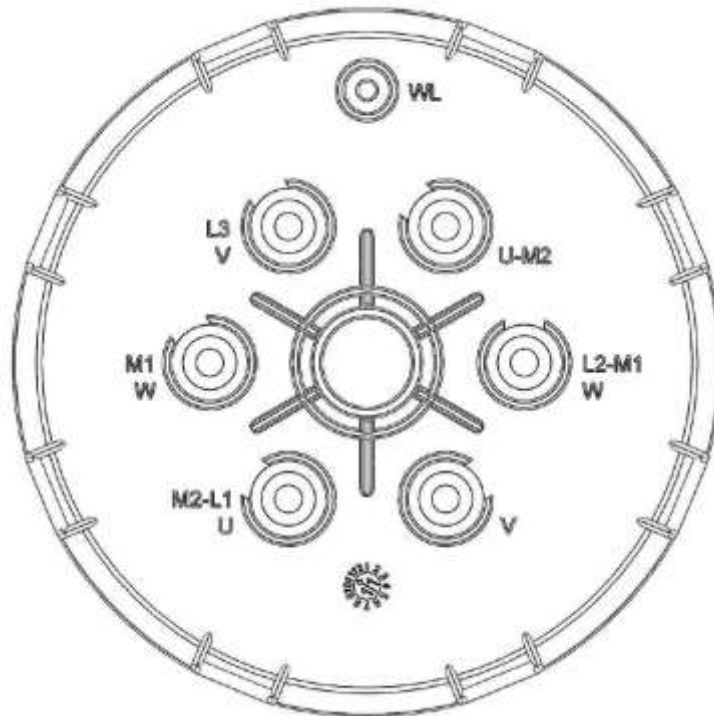

Fig. 12

5. Carefully clean the seat where the new cylinder will be inserted, checking the integrity of the O-ring inside the seat and that there are no pieces of limestone that could compromise the seal.
6. Insert the new cylinder by repeating the operations for removal in reverse. To facilitate insertion, moisten the lower part of the cylinder with water or grease it with technical vaseline oil.
7. Make the electrical connections as shown below:

| CODE | M2-L1 U | V | L2-M1 W | U-M2 | L3 V | M1 W |
|--------------|---------|---------|---------|---------|---------|---------|
| 400UMCLCCU02 | PHASE | / | NEUTRAL | PHASE | / | NEUTRAL |
| 400UMCLCCU01 | PHASE 1 | / | PHASE 2 | / | PHASE 3 | / |
| 400UMCLCCU03 | PHASE 1 | PHASE 3 | PHASE 2 | PHASE 1 | PHASE 3 | PHASE 2 |

Connect the level sensor to the **WL** connector.



8. Perform two or three complete washes of the cylinder immediately after replacement by pressing the “manual discharge key”.
9. Check the absence of water leaks inside the humidifier after one hour of operation from cylinder replacement.



DO NOT USE GREASE OR OILS NOT SUPPLIED IN THE PACKAGE FOR INSERTION OF THE CYLINDER. PERFORM TWO OR THREE COMPLETE WASHES OF THE CYLINDER IMMEDIATELY AFTER REPLACEMENT BY PRESSING THE “MANUAL DISCHARGE KEY”.

7.5

CLEANING THE CYLINDER



When the presence of limestone and deposits inside the cylinder hinders the sufficient passage of current between the electrodes or hinders the discharge of the water, a cleaning operation of the cylinder is necessary.



NEVER EXTRACT THE CYLINDER WITH THE MACHINE HOT AND WITH WATER INSIDE. BEFORE PERFORMING THE OPERATION, EMPTY COMPLETELY THE CYLINDER USING THE MANUAL DISCHARGE KEY! IT IS COMPULSORY TO FOLLOW THE PRESCRIPTIONS INDICATED IN CHAPTER 7.2

1. Extract the cylinder from the humidifier by following the steps 1-4 described in chapter 7.4 .
2. With the use of a screwdriver, open the cylinder by removing the eight clips that keep it attached to the upper cover (fig. 13, 14, 15).

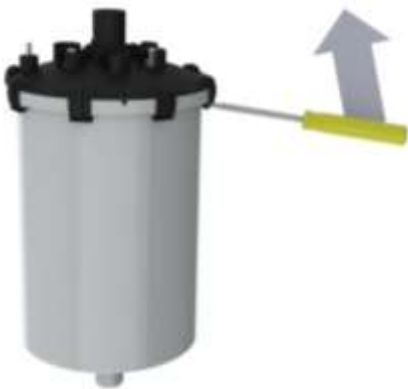

Fig. 13



Fig. 14



Fig. 15

3. Clean and eliminate the scaling present on the electrodes and on the accessible parts by means of mechanical action using a plastic spatula and running water or a mix of water and acetic acid at 20%. Carry out the same operation on the louvres of the lower filter. During cleaning, do not damage or scratch the coupling parts guaranteeing water seal, like the seat of the O-ring at the top of the cylinder and the edge of the lid that presses the O-ring.
4. Clean and check the integrity of the two O-rings, replacing them if required, and check their correct positioning inside the two seats arranged on the cylinder and on the support base. Insert the cylinder repeating the removal operations in reverse order, checking the exact positioning. On the cylinder and on the cover there are 4 references to the correct positioning between the cylinder and the cover, make sure that all 4 references are in their seats during the closing of the clips. The level sensor is usually located towards the rear of the humidifier.
5. Make the electrical connections following the step 7 described in chapter 7.4 .
6. Perform two or three complete washes of the cylinder immediately after reinsertion by pressing the "manual discharge key".
7. Check the absence of water leaks inside the humidifier after one hour from cylinder reinsertion.

CHAP. 8 STEAM DISTRIBUTION

8.1

GENERALITY



A good distribution of steam, to obtain the desired level of humidity in any environment, is linked to two main variables: the amount of steam introduced into the environment and its distribution.

In fact, when the steam is introduced into an environment in a non-homogeneous way, it tends to create saturated zones and zones deficient in humidity, causing a phenomenon of excessive condensation and the difficult control of the production of steam and triggering a "pendulum" effect. It is advisable to introduce the steam with a PEGO steam distributor, inserting it into the air duct or in front of a fan unit where you want to put the steam directly in an environment without an air duct.

8.2

EXAMPLE OF DISTRIBUTION IN AIR DUCT

The PEGO steam distributor must be inserted transversally to the air flow in the duct.

To improve the efficiency of the distribution, the steam distributor must cover the width of the airflow as much as possible.

NB: The maximum airflow pressure in the air duct must not exceed 1,200Pa (fig. 16).

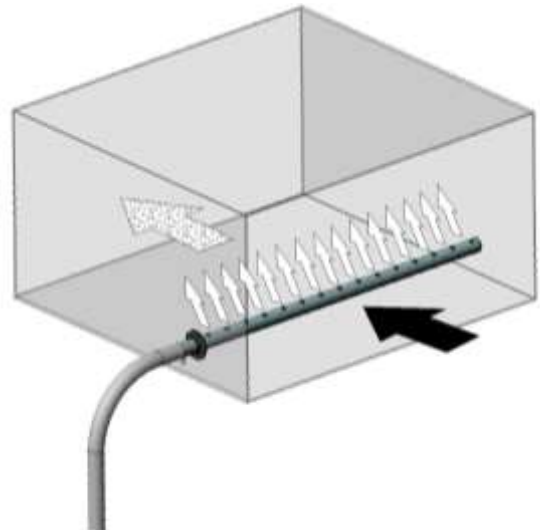

Fig. 16

8.3

EXAMPLE OF DISTRIBUTION IN AMBIENT

The PEGO steam distributor must be positioned transversely in front of the air flow of a fan unit. To improve the efficiency of the distribution, the steam distributor must cover the width of the airflow as much as possible (fig. 17).

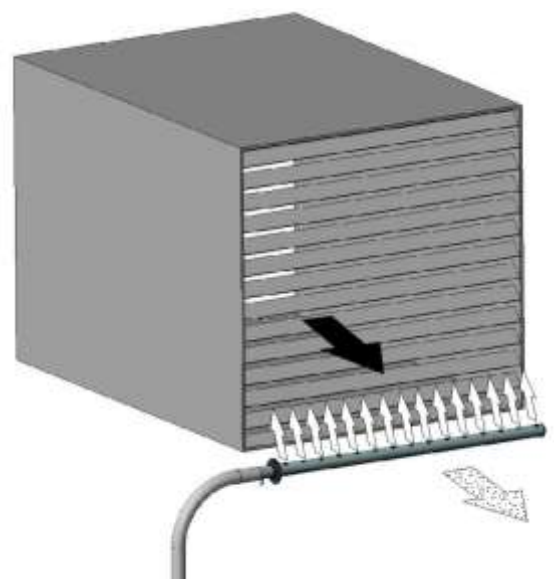

Fig. 17

8.4

CHOOSING A STEAM DISTRIBUTOR

| CODE | TOTAL LENGTH | DISTRIBUTION LENGTH | MATERIAL | STEAM TUBE DIAMETER |
|----------------|--------------|---------------------|------------------|---------------------|
| 400ILAN25X200 | 300mm | 200mm | Stainless steel | 25mm |
| 400ILAN25X250 | 350mm | 250mm | Stainless steel | 25mm |
| 400ILAN25X350 | 450mm | 350mm | Stainless steel | 25mm |
| 400ILAN25X500 | 600mm | 500mm | Stainless steel | 25mm |
| 400ILAN25X650 | 750mm | 650mm | Stainless steel | 25mm |
| 400ILAN25X800 | 900mm | 800mm | Stainless steel | 25mm |
| 400ILAN25X1000 | 1100mm | 1000mm | Stainless steel | 25mm |
| 400ILAN25X1050 | 1150mm | 1050mm | Stainless steel | 25mm |
| 400ILAN25X1100 | 1200mm | 1100mm | Stainless steel | 25mm |
| 400ILAN25X1700 | 1800mm | 1700mm | Stainless steel | 25mm |
| UMILANSAUNA | 260mm | 160mm | Stainless steel | 25mm |
| 400LAN25X200 | 280mm | 200mm | Aluminium | 25mm |
| 400LAN25X250 | 330mm | 250mm | Aluminium | 25mm |
| 400LAN25X350 | 430mm | 350mm | Aluminium | 25mm |
| 400LAN25X500 | 580mm | 500mm | Aluminium | 25mm |
| 400LAN25X650 | 730mm | 650mm | Aluminium | 25mm |
| 400LAN25X800 | 880mm | 800mm | Aluminium | 25mm |
| 400LAN25X1000 | 1080mm | 1000mm | Aluminium | 25mm |
| 400LANSAUNA25 | 109mm | / | Plastic material | 25mm |
| 400LANWEL25 | 156mm | / | Plastic material | 25mm |



PEGO HUMIDIFIERS DIVISION offers the possibility to request steam distributors with customized length.

8.5

CONDENSATION RECOVERY

Regardless of the type of application, a certain amount of condensation forms inside the steam distributor.

This condensation must be drained in order not to obstruct the steam flow.

Condensate recovery is performed by connecting the PEGO UMITUBODN10 tube, specific for this type of application, to the 10mm diameter sleeve of the steam distributor, discharging into a water collection well.

CHAP. 9 ATTACHMENTS

9.1

EU DECLARATION OF CONFORMITY

LA PRESENTE DICHIARAZIONE DI CONFORMITA' E' RILASCIATA SOTTO LA RESPONSABILITA' ESCLUSIVA DEL FABBRICANTE:

THIS DECLARATION OF CONFORMITY IS ISSUED UNDER THE EXCLUSIVE RESPONSIBILITY OF THE MANUFACTURER:



PEGO S.r.l. a socio unico - Via Piacentina 6/b, 45030 Occhiobello (RO) – Italy –
Società soggetta all'attività di direzione e coordinamento di Castel S.r.l.

DENOMINAZIONE DEL PRODOTTO IN OGGETTO / DENOMINATION OF THE PRODUCT IN OBJECT

MOD.: 400ES3MOEMCCU
MOD.: 400ES6OEMCCU

IL PRODOTTO DI CUI SOPRA E' CONFORME ALLA PERTINENTE NORMATIVA DI ARMONIZZAZIONE DELL'UNIONE EUROPEA:

THE PRODUCT IS IN CONFORMITY WITH THE RELEVANT EUROPEAN HARMONIZATION LEGISLATION:

Direttiva Bassa Tensione (LVD): **2014/35/UE**
Low voltage directive (LVD): 2014/35/EU

Direttiva EMC: **2014/30/UE**
Electromagnetic compatibility (EMC): 2014/30/EU

LA CONFORMITA' PRESCRITTA DALLA DIRETTIVA E' GARANTITA DALL'ADEMPIMENTO A TUTTI GLI EFFETTI DELLE SEGUENTI NORME:

THE CONFORMITY REQUIRED BY THE DIRECTIVE IS GUARANTEED BY THE FULFILLMENT TO THE FOLLOWING STANDARDS:

Norme armonizzate:
European standards:

EN 60335-1:2012, EN 60335-2-98:2003, EN 55014-1:2006, EN 55014-2:2015, EN61000-3-2:2014,
EN 61000-3-3:2013, EN 61000-3-11:2000, EN 61000-3-12:2011, EN 61000-6-1:2007, EN 61000-6-2 :2005,
EN 61000-6-3:2007, EN 61000-6-4:2007.

IL PRODOTTO E' COSTITUITO PER ESSERE INCORPORATO IN UNA MACCHINA O PER ESSERE ASSEMBLATO CON ALTRI MACCHINARI PER COSTITUIRE UNA MACCHINA CONSIDERATE DALLA DIRETTIVA: 2006/42/CE "Direttiva Macchine".

THE PRODUCT HAS BEEN MANUFACTURED TO BE INCLUDED IN A MACHINE OR TO BE ASSEMBLED TOGETHER WITH OTHER MACHINERY TO COMPLETE A MACHINE ACCORDING TO DIRECTIVE: EC/2006/42 "Machinery Directive".

Firmato per nome e per conto di:
Signed for and on behalf of:

Pego S.r.l.
Martino Villa
Presidente

Luogo e Data del rilascio:
Place and Date of Release:

Occhiobello (RO), 01/01/2020

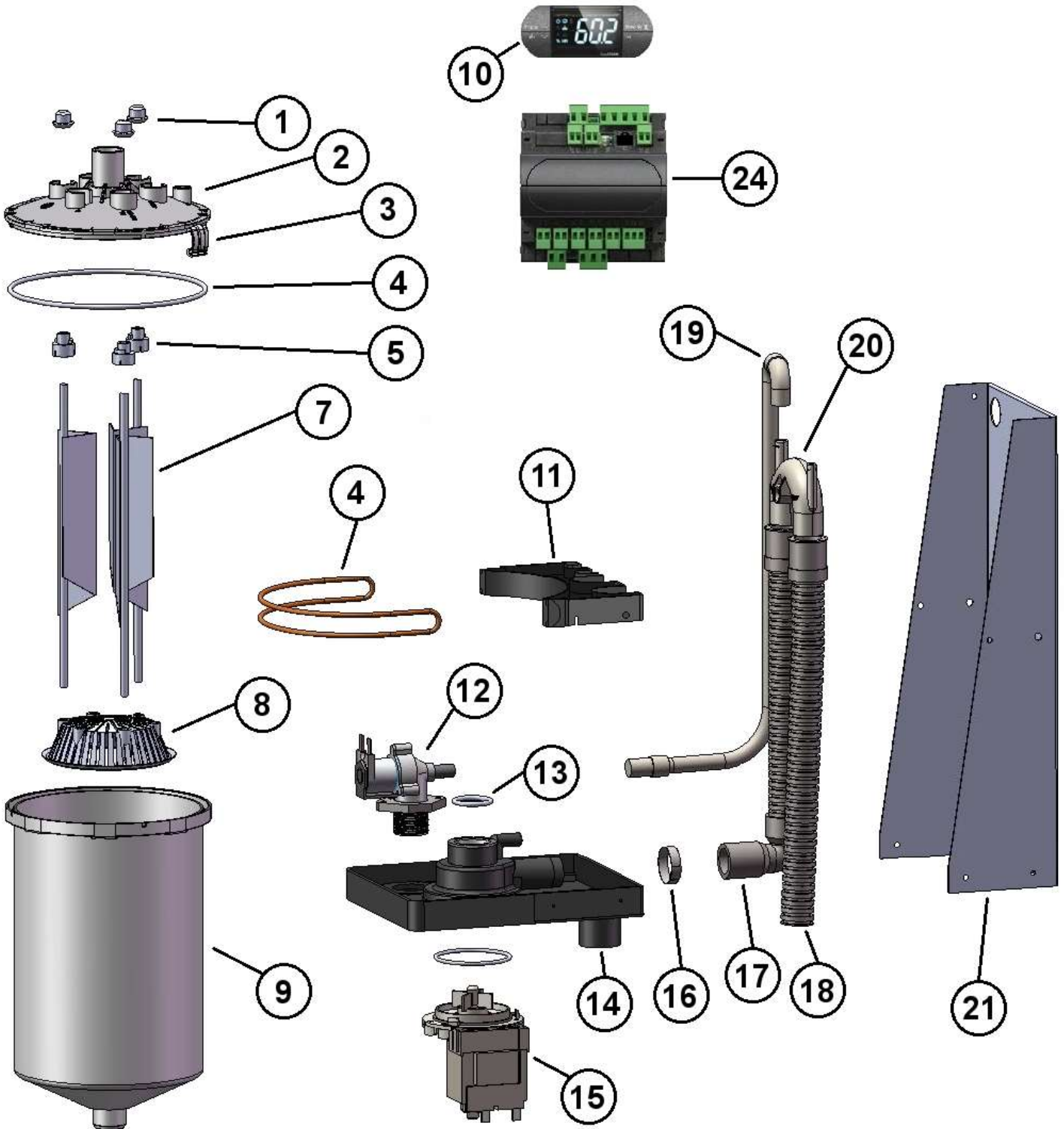

ES-MINI SERIES SPARE PARTS LIST

| Ref. | Code | Description |
|----------------------------|--|---|
| 1 | UMISTHT12 | Protective caps |
| 2 | UMICOCCU | ES-MINI/CCU cylinder cover |
| 3 | UMIGANCCU | ES-MINI/CCU cylinders fixing hook |
| 4 | UMIOR7 | O-ring for cylinder cover |
| 5+7+8 | 400UMEL01 400UMEL02 400UMEL03 | Three-phase electrodes and anti-scale filter replacement kit for ES-MINI/CCU cylinders. Monophase electrodes and anti-scale filter replacement kit for ES-MINI/CCU cylinders. Electrodes and anti-scale filter replacement kit for low conductivity ES-MINI/CCU cylinders. |
| 1+2+3+ 4+5+7+ 8+9+13 | 400UMCLCCU02 400UMCLCCU01 400UMCLCCU03 | Cylinder with capacity 3kg/h, electrodes, anti-scale filter and O-rings replacement kit. Cylinder with capacity 6kg/h, electrodes, anti-scale filter and O-rings replacement kit. Cylinder for low conductivity with capacity 6kg/h, electrodes, anti-scale filter and O-rings replacement kit. |
| 10 | 400HUMESDIS | Display NANO EasySTEAM series |
| 11 | - | ES-MINI/CCU Cylinder Bracket |
| 12 | 400UMIVALV | Water load solenoid 230V 50-60 Hz ES-MINI/CCU |
| 13 | UMIOR5 | O-ring for cylinder base |
| 14 | - | Base support in PP for ES-MINI/CCU |
| 15 | 400UMPO25-150 | Asynchronous drain pump 230V 50Hz (60Hz version available on request) |
| 16+17+ 18+20 | 400UMSIF07 | Complete siphon replacement kit + water drain pump for ES-MINI/CCU |
| 19 | UMITUBO10-8 | ES-MINI/CCU water load tube |
| 21 | - | Steel support for electronic ES-MINI/CCU |
| 23 | CON20161AP01 | Power contactor, electrode power supply ES-MINI |
| 24 | 400HUM2ES3M 400HUM2ES6 | Master HUM2 electronic control for ES3-OEM-CCU Master HUM2 electronic control for ES6-OEM-CCU |
| 10+24 | 400KHUM2ES3M 400KHUM2ES6 | Master HUM2 electronic control kit + NANO Display for ES3-OEM-CCU Master HUM2 electronic control kit + NANO Display for ES6-OEM-CCU |



The spare parts must be requested from own dealer.



PEGO s.r.l.

Via Piacentina, 6/b 45030 Occhiobello ROVIGO – ITALY

Tel. +39 0425 762906

e-mail: info@pego.it – www.pego.it



AFTER-SALES ASSISTANCE

Tel. +39 0425 762906 e-mail: tecnico@pego.it

Distributor: