

NECTOR



Operation and maintenance manual

READ AND KEEP

Rel. Software: 10

Thank you for choosing a PEGO electrical panel.

This manual provides detailed information on the installation, use and maintenance of the NECTOR series electrical panels. Our products are designed and manufactured in compliance with current safety standards, in the specific field of use of refrigeration and air conditioning systems. Different use is allowed provided that the operating conditions for which the panel was designed and manufactured are respected.

Before using the panel, it is advisable to read this manual in full, paying particular attention to the parts highlighted with the symbols described below:



This symbol is placed to indicate notes concerning installation, use and maintenance operations.



This symbol is placed to highlight notes of particular importance.



This symbol is placed to indicate the prohibition to perform the indicated operation.

TABLE OF CONTENTS

INTRODUCTION

1

Page 6	1.1	General information
Page 8	1.2	Product identification codes
Page 9	1.3	Overall dimensions
Page 9	1.4	Product identification data

INSTALLATION

2

Page 10	2.1	Warnings for the installer
Page 10	2.2	Pack contents
Page 11	2.3	Panel installation

FUNCTIONALITY

3

Page 13	3.1	Functions managed by NECTOR
---------	-----	-----------------------------

TECHNICAL SPECIFICATIONS

4

Page 15	4.1	Technical specifications
Page 16	4.2	Warranty conditions

DATA PROGRAMMING

5

Page 17	5.1	Display description
Page 18	5.2	Front keyboard
Page 19	5.3	Key combinations
Page 20	5.4	General information
Page 20	5.5	Symbols
Page 20	5.6	Set point set-up and display
Page 20	5.7	First level programming (user level)
Page 21	5.8	First level parameter list
Page 22	5.9	Second level programming (installer level)
Page 22	5.10	Second-level parameter list
Page 25	5.11	Third level programming (system configurations)
Page 25	5.12	Third level parameter list
Page 28	5.13	Probes display menu (read-only)
Page 28	5.14	Probes display menu parameter list (read-only)
Page 29	5.15	Data logging
Page 29	5.16	Saving data to USB
Page 32	5.17	Software update
Page 32	5.18	Parameter export/Import
Page 33	5.19	Turning on the controller
Page 33	5.20	Operating mode
Page 34	5.21	Evaporator configuration
Page 34	5.22	Manual defrost activation/deactivation
Page 35	5.23	Hot gas defrosting
Page 35	5.24	Resistor thermostat defrosting
Page 35	5.25	Display of ambient temperature during defrosting
Page 35	5.26	Changing of date and time settings
Page 35	5.27	Pump down function
Page 36	5.28	Password protection
Page 36	5.29	Day/night function
Page 36	5.30	Emergency function in case of faulty ambient probe (E0)
Page 37	5.31	Fan speed management – 0-10V output
Page 39	5.32	Cold room door switch management
Page 39	5.33	Humidification and dehumidification management

MONITORING**6**

Page 40	6.1	Connections configuration
Page 44	6.2	myPego App
Page 48	6.3	Integrated webserver / HTTP Access
Page 55	6.4	Telnet monitoring / supervision system
Page 55	6.5	Modbus-RTU Protocol

DIAGNOSTICS**7**

Page 56	7.1	Diagnostics
---------	-----	-------------

MAINTENANCE**8**

Page 58	8.1	General safety rules
Page 59	8.2	Periodic verification
Page 60	8.3	Spare parts and accessories
Page 60	8.4	Cleaning the panel
Page 60	8.5	Disposal

ANNEXES**9**

Page 61	A.1	EU Declaration of Conformity
Page 62	A.2	NECTOR200, NECTOR200CB, NECTOR200CR, NECTOR200B connection diagram
Page 63	A.3	NECTOR200D75 connection diagram

INTRODUCTION

1.1

GENERAL INFORMATION

DESCRIPTION:

NECTOR is a control panel for cold rooms with a single-phase compressor up to 2HP or remote control, that integrates the Datalogger function and various connectivity functions. It complies with Regulation (EC) 37/2005 and with the relative standard EN 12830, with Directives 89/108/EEC, 92/2/EEC and with Italian Legislative Decrees no. 110 of 27/01/92 and no. 493 of 25/09/95, which impose the recording of temperatures of frozen foods and keeping of the relevant data for at least one year.

NECTOR allows the complete management of all the components present on a refrigeration system and stores the main quantities (status of the probes and digital inputs) allowing the rapid daily analysis of data through smartphone apps or more in-depth analysis through the TeleNET program with which to very simply organise, consult and print graphics.

APPLICATIONS:

- Complete management of single-phase refrigeration systems up to 2HP static or ventilated, with stationary or electrical defrosting, with direct compressor stop or pump-down in combination with the Datalogger / Remote control function.
- Single phase evaporating unit management with freon solenoid consent or remote condensing unit consent in combination with Datalogger / Remote control function.

KEY FEATURES:

- Direct compressor management, defrosting resistors, evaporator fans, cold room light.
- Datalogger function with recording up to 2 years of ambient temperature and related alarms. Instrument designation: EN 12830, S, A, 1, measuring range: -45T+99°C.
- Humidification / dehumidification function with dedicated 4-20mA humidity probe.
- Condenser fan speed management with 0-10V analogue output and dedicated pressure probe.
- Evaporator fan speed management with configurable 0-10V analogue output.
- Defrost management at standstill, with resistance, hot gas or thermostatically controlled resistance.
- Possibility to perform defrosting in real time clock.
- Direct management of the hot gas defrosting solenoid.
- Double evaporator management with double defrost end probe.
- Emergency operation (in case of faulty ambient probe).
- Pump-down operation.
- Configurable cold / hot mode.
- Energy saving (day/night setpoint management, intelligent defrosting).

- Instant recording of alarm events and digital inputs.
- Downloading data to external USB memory.
- Software update function via USB.
- Parameter import / export function via USB.
- Backup battery that keeps real-time temperature and humidity recordings active in the absence of the main power supply.
- Control electronics with large display and easy-to-use TOUCH keyboard.
- Ability to display ambient temperature and humidity alternately on the display.
- Integrated differential magnetic-thermal switch for the protection and disconnection of the refrigeration unit.
- Wi-Fi, Ethernet and Bluetooth (BLE) connectivity.
- Bluetooth Functions: Complete remote control of the instrument, configuration of connectivity settings, daily historical display and system status.
- Cloud functions (subscription-enabled function): display of system status in real time; display of parameters and daily history; reception of real-time alarm notifications. Complete remote control of the Nector, if enabled by parameter cCL.
- Integrated local webserver.
- 7 Configurable digital inputs (in 16 modes).
- 2 configurable digital outputs (11 modes).
- RS485 for connection to the TeleNET or ModBUS supervision network
- TeleNET Datalogger software downloadable free of charge from the website www.peggo.it for the storage and consultation of data downloaded with the USB memory from the NECTOR panels.

NECTOR200	<p>Cold room control and management with single-phase compressor up to 2HP static or ventilated and Datalogger function (up to 2 years of recording). USB slot for data download. Differential magnetothermic switch for general protection 16A curve C, Id = 300mA. Outputs with voltage-free contacts. Wi-Fi and Bluetooth connectivity.</p>
NECTOR200CB	<p>Cold room control and management with single-phase compressor up to 2HP static or ventilated and Datalogger function (up to 2 years of recording). USB slot for data download. General protection magnetothermic switch 16A curve C. Outputs with voltage-free contacts. Wi-Fi and Bluetooth connectivity.</p>
NECTOR200D75	<p>Cold room control and management with single-phase compressor up to 2HP static or ventilated and Datalogger function (up to 2 years of recording). USB slot for data download. Three-phase + N electric defrost up to 7500W (2500W x 3). Outputs with voltage-free contacts. Wi-Fi and Bluetooth connectivity.</p>
NECTOR200CR	<p>Cold room control and management with single-phase compressor up to 2HP static or ventilated and Datalogger function (up to 2 years of recording). USB slot for data download. Outputs with voltage-free contacts. Wi-Fi and Bluetooth connectivity.</p>
NECTOR200B	<p>Cold room control and management with single-phase compressor up to 2HP static or ventilated and Datalogger function (up to 2 years of recording). USB slot for data download. Differential magnetothermic switch for general protection 16A curve C, Id = 300mA. Outputs with voltage-free contacts. Wi-Fi and Bluetooth connectivity. Backup battery.</p>

1.3

OVERALL DIMENSIONS

Measurements in mm:





1.4

PRODUCT IDENTIFICATION DATA

The apparatus described in this manual is provided on its side with a plate showing its identification data:

- Manufacturer Name
- Equipment code
- Serial number
- Production date
- Supply voltage
- Degree of protection

 MADE IN ITALY	Standards: EN61326-1+A1+A2+A31 EN12830 EN61000-6-1 EN61000-6-3 EN60730-1/-2-9 EN13485 EN13486	Code: NECTOR200 S.N.: 23000000001 MFG Date: 13/03/23
	CE UK CA	Directive: 2014/35/UE 2014/30/UE RoHS compliant
		Suitability for storage: S Climatic Environment: A Accuracy Class: 1

INSTALLATION

2.1

INSTALLER WARNINGS

- Install the appliance in places that respect the degree of protection and keep the box as intact as possible when drilling for the housing of the cable glands and/or pipe glands.
- Avoid using multi-pole cables in which conductors connected to inductive and power loads and signal conductors are present, such as probes and digital inputs.
- Keep the power cables separate from the battery cables.
- Avoid housing power cables with signal cables (probes and digital inputs) in the same ducts.
- Use only plastic cable glands.
- Reduce the lengths of the connection cables as much as possible, avoiding that the wiring takes on the shape of a spiral capable of possible inductive effects on the electronics.
- All conductors used in the wiring must be suitably proportionate to support the load they must supply.
- If it's necessary to extend the probes, it's mandatory to use conductors with a suitable section and in any case not less than 1mm². Extending or shortening of the probes could alter the factory calibration; then proceed with verification and calibration by means of direct comparison with a thermometer that is ACCREDIA tested and certified.

2.2

PACK CONTENTS

The NECTOR electronic controller, for assembly and use, is equipped with:

- No. 3 Seals, to be interposed between the fixing screw and the bottom of the box.
- No. 1 User manual.
- No. 1 NTC 10K 1% black 1.5m probe.
- No. 1 NTC 10K 1% black 3m probe.
- No. 1 NTC 10K 1% yellow probe of 3m length.
- No. 1 Calibration report.

Fig. 1: Press the buttons on the side doors to release them from the locked position.

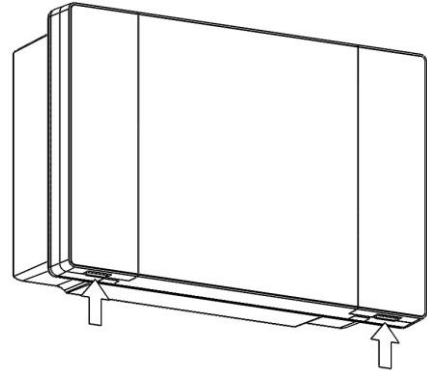

Fig. 2: Lift the two side doors and loosen the four screws that secure the front to the base.

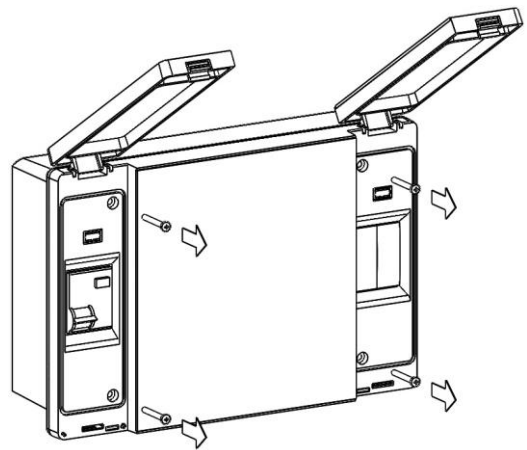

Fig. 3: Open the front of the box by lifting it and sliding the two hinges to the end of the stroke. Bend the hinges and rotate the front 180° downwards to access the inside of the panel.

If there is the buffer battery, pay attention to the cables and disconnect them. Then remove the battery by unscrewing the two fixing screws of the support.

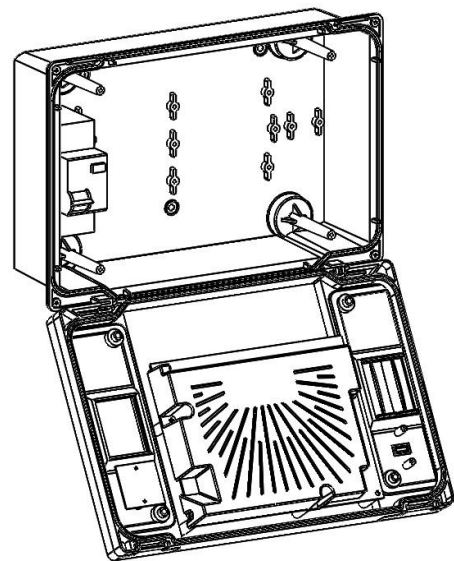
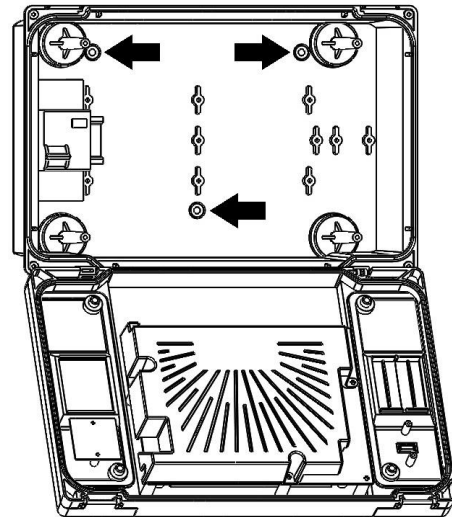

Fig. 4: Using the three pre-existing holes fix the bottom of the box with three screws of adequate length in relation to the thickness of the wall on which to fix the frame. Place a rubber washer (supplied) between each fixing screw and the bottom of the case. Then reassemble the battery (if present).



Make all electrical connections according to the annexes diagrams for the corresponding model (see the related tables in THE ANNEXES). To make the electrical connections reliably and to maintain the degree of protection of the box, it is advisable to use an appropriate cable press and/or pipe press to tighten all the wiring harnesses. It's advisable to distribute the passage of the conductors within the panel as neatly as possible and to keep the power conductors away from the signal conductors. If necessary, use sealing straps.

NOTE: never disassemble the electronic cards.

Fig. 5: Close the front by turning it 180° making sure that all the cables are inside the box, reconnect the battery (if present) and tighten the 4 fixing screws. Connect the supply voltage to the panel and carefully read/program all the set parameters.

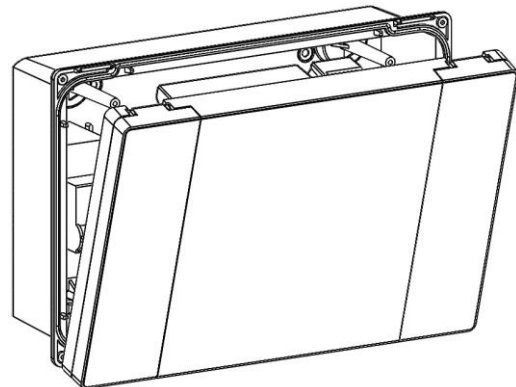

On all loads connected to the NECTOR electronic controller, install overcurrent protection devices for short circuits, to avoid damage to the device. Every intervention and/or maintenance operation must be carried out by disconnecting the panel from the power supply and from all possible inductive and power loads to which it is connected; this is to ensure the maximum safety condition for the operator.

FUNCTIONALITY

3.1

FUNCTIONS MANAGED BY NECTOR

- Direct compressor management, defrosting resistors, evaporator fans, cold room light.
- Display and adjustment of the cold room temperature with decimal point.
- Humidification / dehumidification function with dedicated 4-20mA humidity probe.
- Probe display menu (ambient temperature probe, evaporator temperature probe, Datalogger temperature probe, second evaporator temperature probe or product temperature probe, humidity probe or pressure probe).
- Recording of seven independent digital inputs.
- Activation/deactivation of system control.
- System alarm signalling: probe errors, minimum and maximum ambient temperature/datalogger alarm, differentiated protections for the compressor (thermal, pressure switch, low or high pressure, oil pressure switch), man in cold room alarm, low battery alarm, door open alarm, cold room light alarm, condenser and evaporator fans alarms in display only.
- Evaporator fan management on/off or with speed adjustment with 0-10V output.
- Automatic and manual defrost management (static, resistance, hot gas or thermostatic resistance).
- Intelligent defrost management to optimise consumption.
- Real time clock for defrosting.
- Direct management of the hot gas defrosting solenoid.
- Double evaporator management with double defrost end probe.
- Emergency operation (in case of faulty ambient probe).
- Pump-down operation.
- Configurable cold / hot mode.
- Day/night mode (energy saving).
- Management and direct control of motor compressor unit up to 2HP with clean contacts.
- Cold room light activation with button on the panel or via door switch.
- Password function for managing of 4 levels of access to the instrument parameters.
- 2 Auxiliary relays with activation configurable by parameter.
- Temperature recording and temperature alarms with data availability up to two years (instrument compliant with the standard EN 12830).
- Instant recording of alarm events and digital inputs.
- RS485 for connection to the TeleNET or Modbus–RTU monitoring / supervision network.
- USB slot for downloading data.

- USB software function update.
- Parameter import / export function via USB.
- General protection differential circuit breaker 16A curve C $I_d=300\text{mA}$.
- Backup battery that keeps real-time temperature recordings active in the absence of the main power supply (if present).
- Wi-Fi, Ethernet and Bluetooth (BLE) connectivity.
- Bluetooth Functions: Complete remote control of the instrument, configuration of connectivity settings, daily historical display and system status.
- Cloud functions (subscription-enabled function): display of system status in real time; display of parameters and daily history; reception of real-time alarm notifications.
- Integrated local webserver.

TECHNICAL SPECIFICATIONS

4.1

TECHNICAL SPECIFICATIONS

Power supply		
Voltage	110 - 240 V~ ($\pm 10\%$)	
Frequency	50-60Hz	
Max. power consumption (electronic controls only)	10 W	
Climatic conditions		
Working temperature	0T50°C	
Storage temperature	-20T60°C	
Relative ambient humidity (non-condensing)	Less than 90% Hr	
General characteristics		
Type of connectable probes	NTC 10K 1%	
Resolution	0.1°C	
Measuring range	-45T99°C	
Precision class	1	
Recording function characteristics		
Maximum number of internal memory recordings without overwriting	83460	
General electrical protection:	Bipolar differential magnetothermic switch 16A, curve C Id=300mA	
Inputs		
Analog inputs for NTC probes	4	
Configurable digital inputs	7	
4-20mA Inputs	1	
Outputs (contacts without voltage)		
Compressor	1500W (AC3) 30A	Type of disconnection Relay contacts 1B (micro disconnection)
Resistors	3000W (AC1) 30A	
Fans	500W (AC3) 16A	
Cold room light	800W (AC1) or 100W for 16A LED lights	
Configurable output 1	100W AC1 10A	
Configurable output 2	100W AC1 10A	
Insulation between relay outputs: 2500V		
Dimensional characteristics		
Dimensions	300x200x100mm	
Insulation and mechanical characteristics		
Degree of box protection	IP65	
Box material	Self-extinguishing PC	
Insulation type	Class II	
Environmental pollution	3, normal situation	
Ball pressure test temperature	75°C for the plastic cover and 100°C for the plastic components that carry electricity.	
Designation		
Regulatory reference	EN 12830	
Adequacy	S (storage)	
Type of climate environment	A	
Precision class	1	
Measuring range	°C	
Battery (optional)		
Voltage	12 V	
Type	Ni-Mh 1300 mAh	
Full charging time	26 h	
Autonomy (operation with charged spare battery)	40 h	

The **NECTOR** series electronic controls are covered by warranty against all manufacturing defects for 24 months from the date indicated on the product identification code.

In the event of a defect, the equipment must be shipped with appropriate packaging to our Authorized Facility or Service Centre, upon previous request of the return authorization number.

The Customer is entitled to the repair of the defective equipment including labour and spare parts. Transport costs and risks are borne entirely by the Customer.

Any intervention under warranty does not extend or renew expiry of the same.

The warranty is voided in case of:

- Damage due to tampering, carelessness, inexperience or improper installation of the equipment.
- Installation, use or maintenance not in accordance with the requirements and instructions provided with the equipment.
- Repair operations carried out by unauthorised personnel.
- Damage due to natural phenomena such as lightning, natural disasters, etc.

In all these cases the costs for the repair will be borne by the customer.

Warranty service may be refused when the equipment is modified or transformed.



Under no circumstances will **Pego S.r.l.** be liable for any loss of data and information, costs of substitute goods or services, damage to property, persons or animals, loss of sales or income, interruptions of activities, any direct, indirect, incidental, property, coverage, punitive, special or consequential damages caused in any way, whether contractual, extra-contractual or due to negligence or other liability arising from the use of the product or its installation.

Malfunction caused by tampering, impact, improper installation automatically voids the warranty. It is mandatory to comply with all the instructions in the following manual and the operating conditions of the equipment.

Pego S.r.l. declines all responsibility for the possible inaccuracies contained in this manual, if due to printing or transcription errors.

Pego S.r.l. reserves the right to make any changes to its products that it deems necessary or useful, without affecting their essential characteristics.

Each new release of Pego product manuals replaces all previous releases.

For anything not expressly indicated, the legal provisions in force and in particular art. 1512 OF THE ITALIAN CIVIL CODE apply to the warranty.

For any dispute, the jurisdiction of the Court of Rovigo shall be deemed elected and recognised by the parties.

DATA PROGRAMMING

5.1

DISPLAY DESCRIPTION

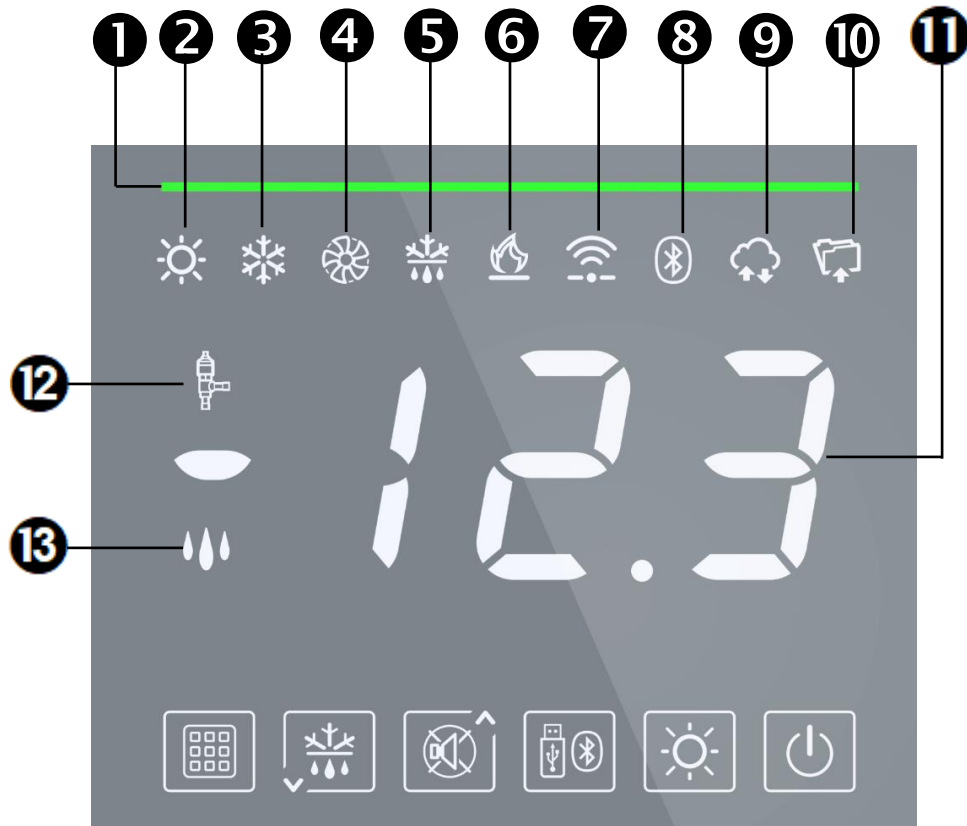

SYSTEM STATUS LINE

The colour indicates a particular state of the system.

OFF: system in standby

GREEN: system active, no call.

BLUE: system active, call cold.

ORANGE: temperature pre-alarm.

YELLOW: system active, defrost in progress (or hot call).

FIXED RED: temperature alarm resolved.

FLASHING RED: alarm active.

1

LIGHT ICON

Fixed on: cold room light on.

Flashing: cold room light on, via door switch.

2

COLD ICON

Fixed on: Compressor call.

3

FAN ICON

Fixed on: Evaporator fans running.

4

DEFROST ICON

Fixed on: Defrost in progress.

Flashing: Dripping in progress.

5

HOT ICON

Fixed on: Heat resistors call.

6

INTERNET CONNECTION ICON

Fixed on: device connected to the Internet (via Wi-Fi or Ethernet).

7

8

BLUETOOTH CONNECTION ICON

Fixed on: Remote device connected via bluetooth.
Flashing: Waiting for connection from remote devices.

9

CLOUD CONNECTION ICON

Fixed on: device connected to Pego Cloud.

10

DATALOGGER ICON

Fixed on: active datalogger (recordings on internal memory, int other than 0).

11

MAIN DISPLAY

Displays the current temperature (or current humidity), parameter value, and identifier of any active alarms.

12

VALVE ICON

Not used.

13

HUMIDIFICATION / DEHUMIDIFICATION ICON

Fixed on: Humidification call active.
Flashing: Dehumidification call active.

5.2

FRONT KEYBOARD

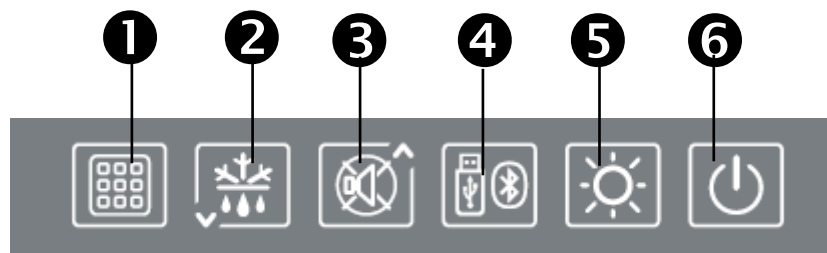

1



SET KEY

When pressed it displays the Ambient Temperature Set and in combination with keys 2 and 3 sets it. Allows the modification of parameters.

2



MANUAL DOWN / DEFROST KEY

If pressed for 3 seconds and the conditions are met, defrost is activated.

3



UP KEY / MUTE BUZZER ALARM

Mute the audible alarm if present.

4



USB DATA EXPORT/BLUETOOTH ACTIVATION KEY

If pressed for 3 seconds, it enters the USB data export menu (see chap. 5.16)
If pressed for 3 seconds, together with key 1, it activates the bluetooth.

5



COLD ROOM LIGHT KEY

Turns the cold room light on and off.

6



STAND BY KEY

If pressed, the system stops and the ambient temperature flashes (compressor outputs, defrost, fans deactivated)

5.3

KEY COMBINATIONS

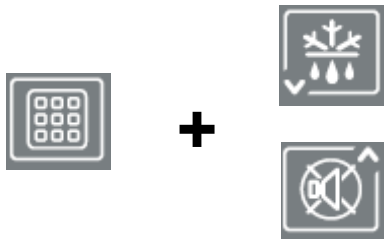
**EDIT SETPOINT / PARAMETERS**

Pressing SET (1) and (▲) or (▼) increases or decreases the value of the setpoint or parameter currently displayed.

**SAVING DATA ON USB STICK**

If pressed for 5 seconds, internal memory data saving to USB memory is enabled. Select the export format with the (▲) and (▼) keys and confirm with the key 1 (SET).

**BLUETOOTH ACTIVATION**

If pressed for 5 seconds, the Bluetooth function is activated (connection via smartphone with the myPego app)

**PROBES DISPLAY**

If pressed for a few seconds, they allow access to the probe display menu/analog output/battery status.

**1ST LEVEL OF PROGRAMMING**

If pressed for a few seconds, they allow access to the first level programming menu.
If pressed for a few seconds in a menu, they save the settings made by exiting the menu.

**2ND LEVEL OF PROGRAMMING (INSTALLER LEVEL)**

If pressed for a few seconds, they allow access to the second level programming menu.

**3RD LEVEL OF PROGRAMMING (SYSTEM CONFIGURATION)**

If pressed for a few seconds, they allow access to the third level programming menu.

5.4

GENERAL INFORMATION



For reasons of safety and greater practicality for the operator, the **NECTOR** system provides three levels of parameter programming; the first for the configuration of parameters that can be frequently modified by the user, the second reserved for the installer for programming of the parameters relating to the various operating modes and the third reserved for the installer dedicated to the configuration of the system.

If first level programming is being performed, it is not possible to directly access the second or third level but instead it is necessary to exit the programming menu beforehand.

5.5

SYMBOLS

For convenience we will indicate with the symbols:

- (▲) the UP key  that performs the value increase and mute alarm function;
- (▼) the DOWN key  that performs the value decrease and defrost forcing function.

5.6

SET-UP AND DISPLAY SETPOINT

1. Press the **SET** key to display the current **SET-POINT** value (temperature).
2. Holding **DOWN THE SET key** and pressing one of the (▲) or (▼) keys changes the **SETPOINT value**.
3. Release the **SET key** to return to the cold room temperature display; the changes made will be automatically saved.

5.7

1st LEVEL PROGRAMMING (User level)

To access the first level configuration menu, you must:

1. Press and hold the (▲) and (▼) keys simultaneously for a few seconds until the first programming parameter appears on the display.
2. Release the (▲) and (▼) keys.
3. Select with the (▲) key or the (▼) key the parameter to be modified.
4. After selecting the desired parameter, you will be able to:
 - Display the setting by pressing the **SET** key.
 - Change the setting by holding down the **SET** key and pressing one of the (▲) or (▼) keys.
5. Once the configuration values have been set, to leave the menu, press and hold the (▲) and (▼) keys for a few seconds until the cold room temperature value reappears. Changes made to the parameters will be automatically saved when leaving the configuration menu.

5.8

1st LEVEL PARAMETERS LIST (User level)

PAR.	MEANING	VALUES	DEFAULT
r0	Temperature differential referring to the main SET-POINT.	0.2 ÷ 10.0°C	2.0°C
d0	Defrost interval (hours)	0 ÷ 24 hours 0 = disabled	4
dd2	Delay to start defrosting on the second evaporator. Defrosting of the second evaporator starts dd2 seconds after the end of defrosting 1. This avoids overloading of the electrical system during defrosting if limited power is available. With dd2=0 defrosts 1 and 2 start simultaneously. dd2 is forced to 0 if d1 = 1 (cycle reversal defrost).	0 ÷ 10 sec 0 = simultaneous start	10 sec
d21	Evaporator 1 defrost end point. Defrosting 1 is not performed if the temperature read by the defrosting probe 1 is higher than the value d21 (in case of a faulty probe defrosting is performed on time).	-35 ÷ 45°C	15°C
d22	Evaporator 2 defrost end point. Defrosting 2 is not performed if the temperature read by the defrosting probe 2 is higher than the value d21 (in case of a faulty probe defrosting is performed on time).	-35 ÷ 45°C	15°C
d31	Maximum defrost duration for evaporator 1 (minutes)	1 ÷ 240 min	25 min
d32	Maximum defrost duration for evaporator 2 (minutes)	1 ÷ 240 min	25 min
d7	Dripping duration (minutes). At the end of defrosting, the compressor and fans remain stationary for the set time d7, the defrosting LED on the front of the panel flashes.	0 ÷ 10 min 0 = disabled	0 min
F5	Fan pause after defrosting (minutes). It allows the fans to remain stationary for a time F5 after dripping. This time is counted from the end of the dripping. If the dripping is not set, at the end of defrosting the fans pause immediately.	0 ÷ 10 min 0 = disabled	0 min
A1	Minimum temperature alarm It's used to define a minimum temperature value for the environment to be chilled. Below the A1 value, the alarm status will be signalled with the alarm LED flashing, the temperature displayed flashing and an internal buzzer acoustically signals the existence of the anomaly.	-45.0 ÷ A2 °C	-45.0°C
A2	Maximum temperature alarm It's used to define a maximum temperature value for the environment to be chilled. Above the A2 value, the alarm status will be signalled with the alarm LED flashing, the temperature displayed flashing and an internal buzzer acoustically signals the existence of the anomaly.	A1 ÷ 99.0 °C	+99.0°C
dFr	Enable real-time defrosting With d0=0 and dFr=1 it is possible to set up to 6 real-time defrosts over a day through the dF1...dF6 parameters.	0 = Disabled 1 = Enabled	0
dF1 ... dF6	Programming of defrost times You can set up to 6 times for defrost.	00:00 ÷ 23:59	00:00
tdS	Start of day phase (not used if ln1...ln7 = 8 or -8)	00:00 ÷ 23:59	06:00
tdE	End of day phase (not used if ln1...ln7 = 8 or -8)	00:00 ÷ 23:59	22:00

5.9

2nd LEVEL PROGRAMMING (Installer level)

To access the second programming level press and hold the UP (▲), DOWN (▼) and LIGHT keys for a few seconds.

When the first programming parameter appears, the system automatically switches to standby.

1. Select with the (▲) key or the (▼) key the parameter to be modified. After selecting it you will be able to:
 - Display the setting by pressing the SET key.
 - Change the setting by holding down the SET key and pressing one of the (▲) or (▼) keys.
2. Once the configuration values have been set, to leave the menu, press and hold the (▲) and (▼) keys for a few seconds until the cold room temperature value reappears. Changes made to the parameters will be automatically saved when leaving the configuration menu. Press the STAND-BY key to enable the electronic control.

5.10

2nd LEVEL PARAMETERS LIST (Installer level)

PAR.	MEANING	VALUES	DEFAULT
F3	Compressor off fan status	0 = Fans running continuously 1 = Fans operating only with the compressor running 2 = Fans disabled	1
F4	Pause fans during defrosting	0 = Fans operating during defrosting 1 = Fans not working during defrosting	1
dPo	Defrost at start-up	0 = disabled 1 = defrost at start-up (if possible)	0
dSE	Intelligent defrosting	0 = disabled 1 = enabled	0
dSt	Smart defrost setpoint (if dSE=1) The time count between defrosts only increases if the compressor is switched on and the evaporator temperature is less than dSt.	-30 ÷ 30°C	1°C
dFd	Display during defrosting (see Chap. 5.25)	0 = current temperature 1 = temperature at the beginning of defrosting 2 = "DEF"	1
Alr	Sound buzzer reactivation delay in case of alarm: when the "mute buzzer alarm" button is pressed (key 3) the sound alarm is deactivated and will be reactivated after Alr minutes.	0 ÷ 240 minutes 0 = deactivated	0 min
Ald	Signalling delay time and display of the minimum or maximum temperature alarm of minimum or maximum temperature.	0 ÷ 240 minutes	120 min
Alt	Reference probes for minimum or maximum temperature alarms.	0 = Ambient probes and Datalogger 1 = Ambient probe 2 = Datalogger Probe	0

PAR.	MEANING	VALUES	DEFAULT
AtE	Temperature alarm enabling	0 = always enabled. 1 = disabled in case of standby. 2 = disabled if door switch active. 3 = disabled if standby or door switch active.	0
C1	Minimum time between shutdown and next compressor power on .	0 ÷ 15 minutes 0 = disabled	0 min
CE1	Compressor ON operating time in case of faulty ambient probe (emergency operation). With CE1=0, the emergency operation remains disabled in the presence of error E0: the compressor remains off and defrosting is inhibited to preserve the residual cold.	0 ÷ 240 min 0 = deactivated	0 min
CE2	Compressor OFF operating time in case of faulty ambient probe (emergency operation).	5 ÷ 240 min	5 min
doC	Compressor guard time for door switch: when the door switch is opened, the evaporator fans turn off and the compressor will continue to run for the doC time, after which it will turn off.	0 ÷ 15 minutes 0 = disabled	0
tdo	Compressor reset time after opening the door: when the door switch is opened and after the time tdo, normal operation of the control is restored by signalling the "open door" alarm Ed .	0 ÷ 240 minutes 0 = disabled	0
tLo	Cold room light alarm signal and display delay time: when the light comes on with the key and after the time tLo, the E9 alarm is activated. If it's silenced and the light is not switched off upon the new expiry of the time tLo, the alarm reappears.	0 ÷ 240 minutes 0 = disabled	0
Fst	Fan block temperature The fans will remain stationary if the temperature value read by the evaporator probe is higher than the value of this parameter.	-45 ÷ +99°C	+99°C
Fd	Differential for Fst	+1 ÷ +10°C	+2°C
LSE	Minimum value attributable to the set-point	-45 ÷ (HSE-1) °C	-45°C
HSE	Maximum value attributable to the set-point	(LSE+1) ÷ 99 °C	+99°C
dnE	Enable day/night (energy saving) During night operation the decimal point flashes.	0 = disabled 1 = enabled	0
nSC	SETPOINT correction factor during night operation (energy saving, with In1 or In2 or In3 = 8 or -8, or tdS/tdE). During night operation the adjustment Set is: Adjustment set = Set + nSC	-20.0 ÷ +20.0°C	0.0°C
StA	Temperature set for auxiliary relay , anti-condensation resistance management.	-45 ÷ +99°C	0°C
StU	Humidity set	0 ÷ 100 %	0

PAR.	MEANING	VALUES	DEFAULT
r1	Humidity differential	1 ÷ 20 %	5
FsE	Evaporator fan speed, only if Ao1=1	20 ÷ 100 %	100 %
StP	Condenser fan pressure set	-0.5 ÷ 90.0 Bar	0
r2	Differential condenser fan pressure SET. Value always above the value of (iOv)	0.6 ÷ 5.0 Bar	2.0 Bar
iOv	Fan inverter offset (pressure)	0.5 ÷ 4.9 bar always < r2	0.5 Bar
iLv	Fan inverter: setting the minimum value of the 0-10V output	0.0 ÷ 10.0 V	3.0 V
iHv	Fan inverter: setting the maximum value of the 0-10V output	0.0 ÷ 10.0 V	10.0 V
bOv	Fan boost: time for which the 0-10V output of the fans is forced to 100% (iHv). This is used to obtain the starting point at their start.	0 ÷ 240 sec	2 sec
int	Temperature recording range. Set the time range between one recording and the next. Set int > 7 to record a year of data.	0 ÷ 60 minutes if int=0 recording is disabled	0
ASr	Enabling asynchronous logging. Normal recording takes place with int range. In case of activation/deactivation of a temperature alarm or of a digital input, an event recording is forced, regardless of the int parameter. It's not possible to determine the time duration of the memory because the number of events recorded in a year is not known beforehand.	0 = disabled 1 = enabled	0
dy	Day setting (see Chap. 5.26)	1 ÷ 31	1
Mo	Month setting (see Chap. 5.26)	1 ÷ 12	1
Yr	Year setting (see Chap. 5.26)	0 ÷ 99	22
Hr	Time setting (see Chap. 5.26)	Hour	12
min	Minute setting (see Chap. 5.26)	Minutes	0
rE2	Secondary software release	## = release	read-only
rEL	Software release: indicates the software version. N.B.: During battery operation, pressing the "STAND-BY" key for 5 seconds the controller turns off.	## = release	read-only

5.11

3rd LEVEL PROGRAMMING (system configurations)

To access the third programming level press and hold the UP (▲) and STANDBY keys for a few seconds.

When the first programming parameter appears, the system automatically switches to standby.

1. Select with the (▲) key or the (▼) key the parameter to be modified. After selecting it you will be able to:
 - Display the setting by pressing the SET key.
 - Change the setting by holding down the SET key and pressing one of the (▲) or (▼) keys.

2. Once the configuration values have been set, to leave the menu, press and hold the (▲) and (▼) keys for a few seconds until the cold room temperature value reappears.

Changes made to the parameters will be automatically saved when leaving the configuration menu. Press the STAND-BY key to enable the electronic control.

5.12

3rd LEVEL PARAMETERS LIST (system configurations)

PAR.	MEANING	VALUES	DEF.
nrE	Number of evaporators: in case of double evaporator also set an auxiliary relay as defrost output 2 (see chap. 5.21).	1 ÷ 2	1
d1	Defrosting type: reverse cycle (hot gas) or resistance (see Chap. 5.22)	0 = A resistance 1 = A hot gas (see Chap. 5.23) 2 = A resistance, thermostat (see Chap. 5.24)	0
Ad	Network address for connection to the TeleNET / Modbus-RTU supervision system.	0 ÷ 31 if SEr=0 1 ÷ 247 if SEr=1	0
Ser	RS-485 communication protocol	0 = TeleNET Protocol 1 = Modbus-RTU protocol	0
Bdr	Modbus baud rate	2 = 1200 5 = 9600 7 = 19200 3 = 2400 6 = 14400 8 = 38400 4 = 4800	5
Prt	Modbus parity check	0 = none 1 = even 2 = odd	0
Enr	Enabling of Datalogger Probe (terminals 5-6)	0 = Disabled 1 = Enabled	1
mod	Thermoregulator operating mode	0 = Cold call 1 = Hot call (in this mode the defrosts and the Fst fan block are excluded)	0
CAL	Ambient probe value correction (terminals 1-2).	-10.0 ÷ +10.0°C	0.0°C
CA4	Probe value correction 4 (terminals 7-8).	-10.0 ÷ +10.0°C	0.0°C
CA5	Probe value correction 5 (terminals 23-24).	-20 ÷ +20 % (An5 = humidity probe)	0
		-10.0 ÷ +10.0 Bar (An5 = pressure probe)	
EP4	Pressure (bar) corresponding to 4mA. Referring to the adjustment probe (An5 = 3).	-1,0 ÷ (EP2-0,1) Bar	0.0 Bar
EP2	Pressure (bar) corresponding to 20mA. Referring to the adjustment probe (An5 = 3).	(EP4+0.1) ÷ 90.0 Bar	30.0 Bar

PAR.	MEANING	VALUES	DEF.
BEE	Buzzer enabling	0 = disabled 1 = enabled	1
An2	Presence of evaporator probe 1: excluding the evaporator probe, defrosting occurs cyclically with period d0 and ends with the intervention of an external device that closes the remote defrosting contact or with the expiry of time d31.	0 = disabled 1 = Evaporator probe 1	1
An4	Probe configuration 4 (NTC) (terminals 7-8)	0 = disabled 1 = defrosting 2 2 = product temperature (reading and recording)	0
An5	Probe configuration 5 (4-20 mA) (terminals 23-24)	0 = disabled 1 = humidity probe (adjustment and recording) 2 = humidity probe (alternate reading at room temperature, adjustment and recording) 3 = high pressure probe (for condenser fan management, AUx=+/-9)	0
Ao1	0-10V Output configuration	0 = disabled 1 = evaporator fan adjustment (fixed speed FsE) 2 = condenser fan adjustment (requires An5=3)	0
in1	INP-1 digital input setting (terminals 9-10)	16 = Compressor protection, display only (N.O., EcA) 15 = Condenser fan protection, display only (N.O., EFc) 14 = Evaporator fan protection, display only (N.O., EFE) 13 = Oil pressure switch protection (N.O., EcO) 12 = Minimum pressure switch protection (N.O., EcL) 11 = Maximum pressure switch protection (N.O., EcH) 10 = Pressure switch protection (N.O., EcP) 9 = Compressor thermal protection (N.O., Ect) 8 = Night input (energy saving) (N.O.) 7 = Remote defrost stop (N.O., active on the ascent front) 6 = Start defrosting remotely (N.O., active on the ascent front) 5 = Remote standby (N.O.) To indicate the remote standby OFF is displayed on the display 4 = Pump-down pressure switch (N.O.) (see Chap. 5.27) 3 = Man in Cold room alarm (N.O.) 2 = Compressor protection (N.O.) 1 = Door switch (N.O.) 0 = disabled -1 = Door switch (N.C.) -2 = Compressor protection (N.C.) -3 = Man in Cold room Alarm (N.C.) -4 = Pump-down pressure switch (N.C.) (see Chap. 5.27) -5 = Remote Stand-by (N.C.) To indicate the remote standby OFF is displayed on the display -6 = Start defrost remotely (N.C., active on the descent front) -7 = Stop defrost remotely (N.C., active on the descent front) -8 = Night input (energy saving) (N.C.) -9 = Compressor thermal protection (N.C., Ect) -10 = Pressure switch protection (N.C., EcP) -11 = Maximum pressure switch protection (N.C., EcH) -12 = Minimum pressure switch protection (N.C., EcL) -13 = Oil pressure switch protection (N.C., EcO) -14 = Evaporator fan protection, display only (N.C., EFE) -15 = Condenser fan protection, display only (N.C., EFc) -16 = Compressor protection, display only (N.C., EcA)	1
in2	INP-2 digital input setting (terminals 11-12)	- Same legend as in1 values -	2
in3	INP-3 digital input setting (terminals 13-14)	- Same legend as in1 values -	3

PAR.	MEANING	VALUES	DEF.
in4	INP-4 digital input setting (terminals 15-16)	- Same legend as in1 values -	5
in5	INP-5 digital input setting (terminals 17-18)	- Same legend as in1 values -	9
in6	INP-6 digital input setting (terminals 19-20)	- Same legend as in1 values -	10
in7	INP-7 digital input setting (terminals 21-22)	- Same legend as in1 values -	15
AU1	Relay management alarm/auxiliary 1 (AUX1)	12 = dehumidification output (N.O.) 11 = defrost output 2 (N.O.) 10 = active night mode (N.O.) 9 = condenser fan consent (N.O., managed if An5=3, high pressure probe) 8 = liquid solenoid (N.O., for hot gas defrosting management) 7 = humidify call, only if An5=1 or 2 (N.O.) 6 = hot call (N.O.) 5 = relay energised during standby (N.O.) 4 = energised with compressor output energised. Used for condensing units. (N.O.) 3 = pump-down function (N.O.) (see Chap. 5.27) 2 = automatic auxiliary relay managed by temperature set StA with differential 2°C (N.O.) 1 = relay energised in presence of alarm (N.O.) 0 = disabled -1 = relay de-energised in presence of alarm (N.C.) -2 = automatic auxiliary relay managed by temperature set StA with differential 2°C (N.C.) -3 = pump-down function (N.C.) (see Chap. 5.27) -4 = relay de-energised with compressor output energised. Used for casing resistance. (N.C.) -5 = relay de-energised during standby (N.C.) -6 = hot call (N.C.) -7 = humidification call (N.C.), only if An5=1 or 2 -8 = liquid solenoid (N.C., for hot gas defrosting management) -9 = condenser fan consent (N.C., managed if An5=3, high pressure probe) -10 = active night mode (N.C.) -11 = defrost output 2 (N.C.) -12 = dehumidification output (N.C.)	-1
AU2	Relay management alarm/auxiliary 2 (AUX2)	- Same legend as AU1 values -	4
cE	Network connection type	0 = Ethernet 1 = Wifi	0
cB	Bluetooth Management	0 = Bluetooth disabled 1 = Bluetooth activatable	1
cCL	Cloud management	0 = disabled 1 = active, read data only 2 = active, read/write parameters and commands	2
cSL	Local web server management	0 = disabled 1 = active (data display only) 2 = active (data display and command reception)	2
P1	Password: protection type. Active when PA is other than 0 (see Chap. 5.28).	0 = Displays only the set point and allows alarm silencing. Blocks all other functions. 1 = Displays set point, access to light buttons, defrosting and silent alarms. 2 = Blocks access in first, second and third level programming. 3 = Blocks access in second and third level programming.	3

PAR.	MEANING	VALUES	DEF.
PA	Password. (see P1 for type of protection).	0...999 0 = Function disabled	0
crE	Enabling automatic reconnection If crE>0, the Nector is periodically reconnected to the web/cloud/bluetooth every crE hours, resolving any network errors.	0 ... 24 hours 0 = Function disabled	0
dEF	Setting the default parameters Go to parameter dEF and press all the keys at the same time for 10 seconds to restore the default parameters.	---	---

5.13

PROBES DISPLAY MENU (read-only)

To access the probe display level press and hold the DOWN (▼) and STANDBY keys for a few seconds. The parameters of this level represent instantaneous reading of the probes and are therefore not editable.

Select with the (▲) key or the (▼) key the parameter to be displayed. After selecting it, it's possible to view its value by pressing the SET key.

To exit the menu, press and hold the (▲) and (▼) keys for a few seconds until the cold room temperature value reappears.

5.14

PROBES DISPLAY MENU PARAMETERS LIST (read-Only)

PAR.	MEANING	VALUES	DEFAULT
S1	Probe 1 display, ambient temperature < °C >	-45.0 ÷ +99.0°C	read-only
S2	Probe 2 display, evaporator 1 temperature < °C > (displays ' --- ' if An2 =0)	-45.0 ÷ +99.0°C	read-only
S3	Probe 3 display, ambient temperature datalogger recording probe. < °C > (displays ' --- ' if Enr =0)	-45.0 ÷ +99.0°C	read-only
S4A	Probe display 4, evaporator temperature 2 < °C > (displays ' --- ' if An4=0 or 2)	-45.0 ÷ +99.0°C	read-only
S4b	Probe display 4, product probe temperature < °C > (displays ' --- ' if An4=0 or 1)	-45.0 ÷ +99.0°C	read-only
S5A	Probe display 5, humidity probe < HR% > (displays ' --- ' if An5=0 or 3)	0 ÷ 100 HR%	read-only
S5b	Probe display 5, pressure probe < Bar > (displays ' --- ' if An5=0, 1 or 2)	EP4 ÷ EP2 Bar	read-only
o1	Output value 0-10Vdc < V >	0.0-10.0 Vdc	read-only
BAt	Backup battery status	No mains power supply: Level 0 ... 100 % Mains power supply present: 0 = battery disconnected or broken 1 = battery charging 2 = battery charged	read-only



To start recordings set int > 0

Recordings occur in the intervals established by the **int** parameter, or in case of events if ASr = 1.

The information recorded is:

- Ambient temperature (IN_1)
- Evaporator temperature (IN_2)
- Datalogger probe temperature (IN_3)
- Probe temperature configurable via An4 (IN_4)
- Probe pressure / humidity configurable via An5 (IN_12)
- Min or max temperature alarm on ambient probes and datalogger
- Standby status
- Probe configuration (parameters An2, Enr, An4, An5)
- Switching on the device
- Digital input status 1 (IN_5)
- Digital input status 2 (IN_6)
- Digital input status 3 (IN_7)
- Digital input status 4 (IN_8)
- Digital input status 5 (IN_9)
- Digital input status 6 (IN_10)
- Digital input status 7 (IN_11)
- Absence of power (battery operated)

The advance of date and time entails the deletion of data after the new set date (in the case of data export to the Telenet).

Note: Set int > 7 minutes to obtain one year of recordings.

Through the TeleNET program it is possible to store, consult, view graphs and to print quickly and easily the data downloaded from the NECTOR panels. Alternatively, it is possible to download all the data stored in the NECTOR EXPERT in standard comma-separated values (CSV) format that can be viewed on PC with any spreadsheet.

To save internal memory data to the USB device it is necessary to:

1. Use USB memory models (USB stick, USB-SD adapter, etc.) formatted as **FAT32**.
2. Insert the USB stick into the slot on the front panel.
3. Press the key  for 5 seconds.
4. Select the type of export (move with the (▲) and (▼) keys):
 - **No:** exits the save level.
 - **pg3:** Export data in secure format compatible with the TeleNET supervision software.
 - **CSv:** Export data in standard table text format.



Confirm the save with the key

5. **Wait:** at the end of the saving, a short beep is emitted.
6. If an error related to the USB memory occurs, a long beep sounds and **Eu** flashes with one of the following error codes:
 - 1 – disconnect during save or offline memory
 - 2 – Physical error / unable to write to disk
 - 3 – invalid path
 - 4 – access prohibited
 - 5 - read-only unit
 - 6 – incorrect file system/invalid device name
 - 7 – 999 files (pg3 or csv) on USB exceeded
 - 8 – generic USB alarm
 - 9 – parameter import error
7. In the event of an error while saving data, it will be necessary to remove the cause and to repeat the operation.
8. After saving, remove the USB stick from the panel and insert it into your computer.
9. Use TeleNET's "Automatic Import" function to simply import data in "pg3" format, or display "CSV" data via a spreadsheet.

Refer to the TeleNET manual for a better understanding of the functions and options available including the importing of data, the viewing of recordings and alarms, customizable graphics, unique tool identification.

Note: The file names *.pg3 and *.csv contain the instrument serial number. To allow TeleNET to import the data correctly, the names of the exported files should not be changed.

TeleNET - Example of graph obtained by importing data from NECTOR (PG3)



Example of a table obtained by exporting data from NECTOR (CSV)

The table in the example shows a number of asynchronous recordings due to an alarm event on channel 1 (ASr = 1).

	A	B	C	D	E	F	G	H	I	J
1	ADDRESS	DATE	TIME	PROBE1 (0.1°C)	PROBE2 (0.1°C)	PROBE3 (0.1°C)	PROBE4 (0.1°C)	PROBE5 (0.1Bar)/RH%	EL1	EH1
2										
3	161	04/09/2020	14:42:00	249	-279	250	999	54	0	0
4	160	04/09/2020	14:41:49	249	-279	250	999	54	0	0
5	159	04/09/2020	14:32:00	249	-279	250	999	55	0	0
6	158	04/09/2020	14:31:00	249	-279	250	999	55	0	0
7	157	04/09/2020	14:30:00	249	-279	250	999	55	0	0
8	156	04/09/2020	14:29:00	249	-279	250	999	55	0	0
9	155	04/09/2020	14:28:00	249	-279	250	999	55	0	0
10	154	04/09/2020	14:27:00	249	-279	250	999	55	0	0
11	153	04/09/2020	14:26:00	249	-279	250	999	55	0	0
12	152	04/09/2020	14:25:00	249	-279	250	999	55	0	0
13	151	04/09/2020	14:24:00	249	-279	250	999	55	0	0
14	150	04/09/2020	14:23:00	249	-279	250	999	55	0	0
15	149	04/09/2020	14:22:00	249	-279	250	999	54	0	0
16	148	04/09/2020	14:21:53	249	-279	250	999	54	0	0
17	147	04/09/2020	14:14:00	249	-279	250	999	55	0	0
18	146	04/09/2020	14:13:00	249	-279	250	999	55	0	0
19	145	04/09/2020	14:12:00	249	-279	250	999	55	0	0
20	144	04/09/2020	14:11:00	249	-279	250	999	55	0	0

K	L	M	N	O	P	Q	R	S	T	U	V	W	X	Y	Z	AA	AB
EL3	EH3	STAND-BY	An2=1	Enr=1	An4=1	An4=2	An5=1/2	An5=3	POWER ON	DI1	DI2	DI3	DI4	DI5	DI6	DI7	BATTERY
0	0	0	1	1	0	0	0	1	0	0	0	0	0	0	0	0	0
0	0	1	1	1	0	0	0	1	1	0	0	0	0	0	0	0	0
0	0	1	1	1	0	0	0	1	0	0	0	0	0	0	1	0	0
0	0	1	1	1	0	0	0	1	0	0	0	0	0	0	1	0	0
0	0	1	1	1	0	0	0	1	0	0	0	0	0	0	1	0	0
0	0	1	1	1	0	0	0	1	0	0	0	0	0	0	1	0	0
0	0	1	1	1	0	0	0	1	0	0	0	0	0	0	1	0	0
0	0	1	1	1	0	0	0	1	0	0	0	0	0	0	1	0	0
0	0	1	1	1	0	0	0	1	0	0	0	0	0	0	1	0	0
0	0	1	1	1	0	0	0	1	0	0	0	0	0	0	1	0	0
0	0	1	1	1	0	0	0	1	0	0	0	0	0	0	1	0	0
0	0	1	1	1	0	0	0	1	0	0	0	0	0	0	1	0	0
0	0	1	1	1	0	0	0	1	0	0	0	0	0	0	1	0	0
0	0	1	1	1	0	0	0	1	0	0	0	0	0	0	1	0	0

COLUMN DESCRIPTION

DATES: Date of recording

TIME: Time of recording

PROBE1 (0.1°C): Ambient probe temperature (IN_1)

PROBE2 (0.1°C): Evaporator probe temperature (IN_2)

PROBE3 (0.1°C): Datalogger probe temperature (IN_3)

PROBE4 (0.1°C): Probe temperature configurable with An4 (IN_4)

PROBE5 (0.1Bar/RH%): Relative probe pressure/humidity configurable with An5 (IN_12)

EL1: low ambient temperature alarm

EH1: high ambient temperature alarm

EL3: Datalogger low temperature alarm

EH3: Datalogger high temperature alarm

STAND-BY: Stand-by system

An2=1: evaporator probe enabled on PROBE2 (IN_2)

Enr=1: datalogger probe enabled on PROBE3 (IN_3)

An4=1: evaporator probe 2 enabled on PROBE4 (IN_5)

An4=2: product probe enabled on PROBE4 (IN_5)

An5=1/2: humidity probe enabled on PROBE5 (IN_12)

An5=3: pressure probe enabled on PROBE5 (IN_12)

POWER-ON: start of the NECTOR (recording performed asynchronously, regardless of the parameter 'int': in this way it is possible to understand when the power returns).

DI1: Digital input DI1 active (IN_5)

DI2: Digital input DI2 active (IN_6)

DI3: Digital input DI3 active (IN_7)

DI4: Digital input DI4 active (IN_8)

DI5: Digital input DI5 active (IN_9)

DI6: Digital input DI6 active (IN_10)

DI7: Digital input DI7 active (IN_11)



BATTERY: Battery operated. If BATTERY=1 is out of mains power; the controller continues to record temperature trends for approximately 40 hours (with battery present and charged).

5.17

SOFTWARE UPDATE

The NECTOR line dashboard control software can be updated automatically via the USB port used to download the data.

To update or update the software it is necessary to:

1. Download the latest version available from www.pego.it, verify that the release is higher than the one already present in the NECTOR (rEL parameter).
2. Insert the USB stick into the slot on the front panel.
3. Press the key  for 5 seconds and select the “**Upd**” item.
4. Press the SET  key to confirm. The NECTOR controller automatically exports the set parameters, all the data in memory (in pg3 and csv format), then proceeds automatically with the update.

The update clears all internal data store records, and the parameters are restored to the values prior to the update.

Note: never remove the USB stick and do not disconnect the power to the panel until the end of the update.

5.18

PARAMETER EXPORT/IMPORT

The parameters set in the NECTOR can be exported/imported via the USB port used to download the data. To do this, proceed as follows:

1. Insert the USB stick into the slot on the front panel.
2. Press the key  for 5 seconds and select the item “**PrE**” to export the parameters, “**Pri**” to import the parameters from the USB (in this case there must be a file previously exported on the USB memory).

3. Press the SET  key to confirm. The NECTOR controller automatically exports / imports the set parameters and device status.

Note: the generated file (name: **NECT_200.PAR**) can be imported to other NECTOR panels to obtain an identically configured tool.

5.19

TURNING ON THE CONTROLLER

After completing complete wiring of the electronic controller, apply 230Vac voltage; the electrical panel will immediately emit a sound of a few seconds and at the same time all the segments, keys and symbols will remain on the display.

5.20

OPERATING MODE

Parameters: mod, AU1, AU2 (3°).

The mode of operation depends on the third level parameter **mod**.

COLD mode (mod parameter = 0)

The **NECTOR** controller activates the compressor command when the ambient temperature exceeds the set value plus the differential ($r0$); switches off the compressor when the room temperature is lower than the set value.

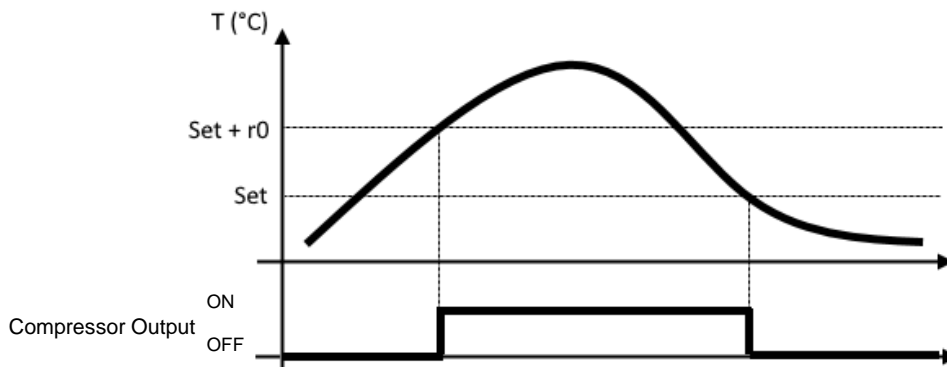

NEUTRAL ZONE mode (Parameter mod = 0)

The **NECTOR** controller activates the compressor command when the ambient temperature exceeds the set value plus the differential ($r0$); switches off the compressor when the room temperature is lower than the set value. When the room temperature falls below the set value minus the differential ($r0$), the controller activates the heating element command (**auxiliary output configured as a heating call**); it switches off the resistance when the room temperature is higher than the set value.

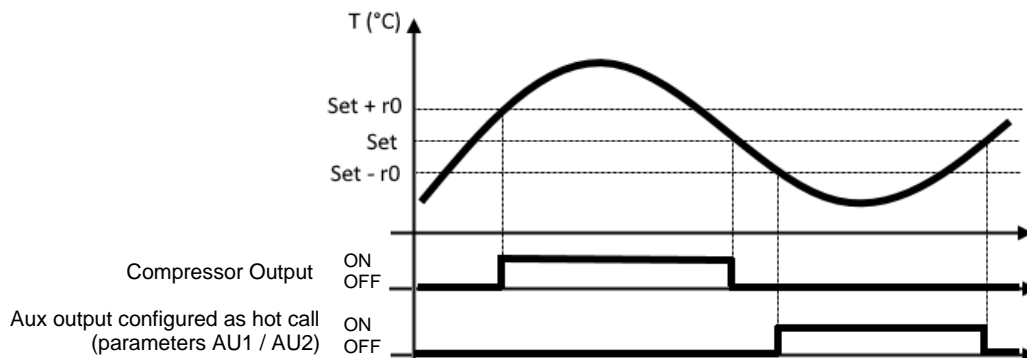

HOT mode (mod parameter = 1)

The **NECTOR** controller activates the heating element command when the room temperature drops below the set value minus the differential ($r0$); it switches off the resistance when the room temperature is higher than the set value. With $mod = 1$ it is possible to connect the heating resistances also to the compressor output (which bears resistive loads greater than the configurable outputs, see chap. 4.1). Cold calling is always off.

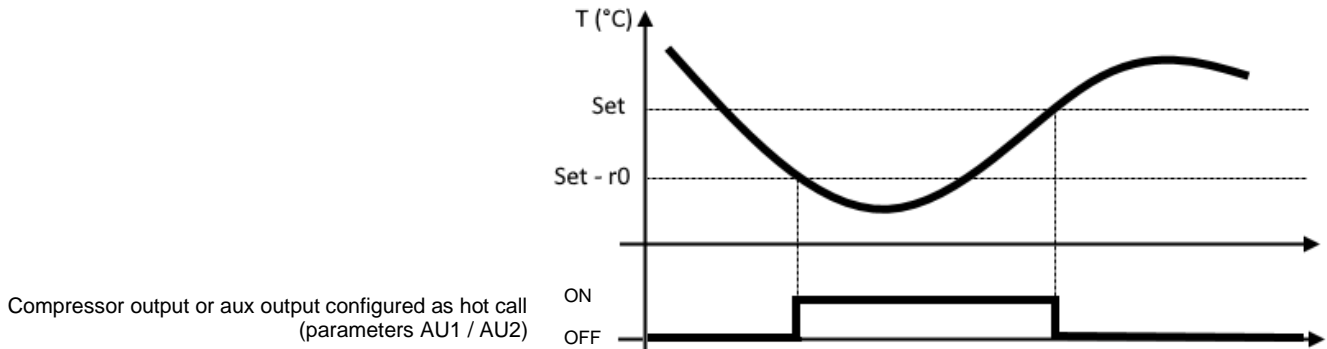

5.21

EVAPORATORS CONFIGURATION

Parameters: nrE (3°).

The choice of the number of evaporators is managed by the nrE parameter:

- In case of double evaporator set nrE=2 and enable one of the two auxiliary relays as evaporator defrost output 2: AU1 or AU2 = 11 or -11. If evaporator probe 2 is used, activate analog input An4=1.
- If nrE=1 is set, evaporator probe 2 is disabled, parameters d22 and d32 are ignored, "---" is displayed in parameter tE2.

In the case of defrosting with 2 evaporators, before restarting with the normal thermostat it is expected that the defrosting will be completed on both evaporators.

5.22

MANUAL DEFROST ACTIVATION/DEACTIVATION

Parameters: d21 (1st), d22(1st), d31 (1st), d32 (1st), dd2 (1st).



To activate defrosting, simply press the key  for a few seconds; in this way, if the conditions are met, the defrosting output will be activated.

Defrosting of each of the two evaporators will end when the defrosting end temperature associated with it is reached (parameters d21 and d22) or for maximum defrosting duration (parameters d31 or d32). The defrost sequence and delays set with parameter dd2 will also be respected.

Each of the two defrost outputs is not activated if the temperature set in the relative end defrost parameter (d21 or d22) is lower than the temperature detected by the probe of its own evaporator. Manual defrosting is possible even if the real-time clock defrosts have been set.



During a defrost in progress, pressing the key  for 3 seconds forces the end of both defrosts.

5.23

HOT GAS DEFROSTING

Parameters: d1 (3°).

Set parameter d1 =1 for hot gas defrost management.

The compressor relay and defrost relays are activated throughout the defrost phase.

For the correct management of the system:

- Connect the cycle reversal solenoid valve to the defrost output.
- Connect the liquid solenoid valve to the liquid solenoid valve outlet (AUx = +/- 8)

Doing so during the defrosting phase will ensure closing of the liquid solenoid valve and activation of the hot gas defrosting cycle.

For capillary systems (without thermostatic valve) simply control the cycle reversal solenoid valve using the defrost control.

5.24

DEFROST WITH THERMOSTAT RESISTORS

Parameters: d1 (3°), d21 (1°), d22(1°), d31 (1°), d32 (1°).

Set parameter d1=2 to manage the defrost with resistors within a time limit. During defrosting the defrost relay is activated if the temperature read by the defrost probe is below the defrost end threshold (d21 or d22). The defrost phase lasts d31 / d32 minutes, regardless of the relay status. This allows a better defrosting of the evaporator with consequent energy savings.

5.25

AMBIENT TEMPERATURE DISPLAY
DURING DEFROSTING

Parameters: dFd (2°).

During defrosting and for the next minute:

- if dFd=0 the display continues to display the current ambient temperature value.
- if dFd=1 the display continues to display the last ambient temperature value detected before defrosting begins.
- if dFd=2 the display shows the words "dEF".

5.26

CHANGING THE DATE AND TIME SETTINGS

Parameters: Hr (2°), min (2°), Yr (2°), Mo (2°), dy (2°).

Modification of the date and time settings takes place simply by varying the **dy**, **Mo**, **Yr** and **Hr**, **min** value set following the parameter setting procedure, described in chapter 5.10 of this manual (2nd level programming).

An advance of the date entails loss of the data recorded since that period, in the case of data export to the TeleNET supervisory system.

5.27

PUMP DOWN FUNCTION

Parameters: AUx (3°), Inx (3°).

Setting the parameter **AU1/2=+/- 3** and **in1/2/3/4/5/6/7 = +/- 4** activates the compressor stop operation in pump down. The digital input **IN1/2/3/4/5/6/7** becomes the working pressure switch input and directly manages the compressor output. The AU1/2 relay becomes the evaporator solenoid call and is managed by the thermostat cold call.

5.28

PASSWORD PROTECTION

Parameters: PA (2°), P1 (2°).

The password function is activated by setting a value other than 0 for the **PA** parameter. See parameter **P1** for different security levels.

Protection is automatically enabled after about 2 minutes of inactivity on the keyboard.

The figure 000 appears on the display. Use the (▲) and (▼) keys to change the number and the **SET** key to confirm it.

If you forget your password, use the universal number 100.

5.29

DAY/NIGHT FUNCTION

Parameters: dnE (2°), nSC (2°), tdE (1°), tdS (1°), inx (3°).

The day/night function is activated by setting the parameter dnE=1. It saves energy by allowing the temperature setpoint to change in a specific time slot or when the digital night input is active (if in1/2/3/4/5/6/7= +/- 8).

During night operation the adjustment setpoint is:

$$\text{Adjustment set} = \text{Set} + nSC$$

The night time slot operation is active if dnE=1 and the current time is > tdE and < tdS (first level parameters). The time slot is ignored if at least one input is configured as a night input (in1/2/3/4/5/6/7 = ±8).

5.30

EMERGENCY OPERATION IN CASE
OF FAULTY AMBIENT PROBE (E0)

Parameters: CE1 (2°), CE2 (2°).

This safety mode ensures the operation of the compressor even in the event of a faulty environment probe (error E0).

With probe error E0 and CE1 other than 0, the compressor operates in work pause mode, with compressor ON for time CE1 and OFF for time CE2.

With CE1>0, in case of error E0, defrosts are managed as in the normal operating mode.

With CE1=0, the emergency operation remains disabled in the presence of error E0: the compressor remains off and defrosting is disabled to preserve the residual cold.

Eliminate the cause of error E0 as soon as possible and reactivate the normal function of the control for a correct temperature adjustment.

NOTE: Emergency mode is only active in cold mode (mod parameter =0).

Parameters: Ao1 (3°), An5 (3°), Au1/2 (3°), FsE (2°).

CONDENSER FAN MANAGEMENT

If Ao1=2, An5=3 and AU1/2 = +/- 9 the condenser fans are managed with the 0-10V output and sideband type adjustment. The configured auxiliary digital output (AU1 or AU2) is used as consent. The fan speed adjustment follows the operation of graph no. 1 as the delivery pressure read by the probe An5 increases and graph no. 2 as it decreases.

INCREASING pressure (Graph 1):

The analog output of the regulator will be 0V for probe pressure values less than or equal to the point (B) representing the "StP parameter setpoint + iOu offset" value.

If the pressure value of the pressure probe exceeds point (B) the analog output will be 10V for the maximum time bOu. bOu is the Fan Boost time for which the regulator output is increased to 100% to help the fans start.

Between point (B) and point (C) the analogue output will have a value proportional to the value of the pressure probe starting from the minimum value of the parameter (iLv) until reaching of the maximum value of 10V.

With pressure values of the pressure probe equal to or greater than point (C) the analog output will be 10V.

The digital output fans 1 represents "capacitor fan inverter enable" and is ON for pressure values greater than or equal to the set point and OFF for lower values.

Graph 1

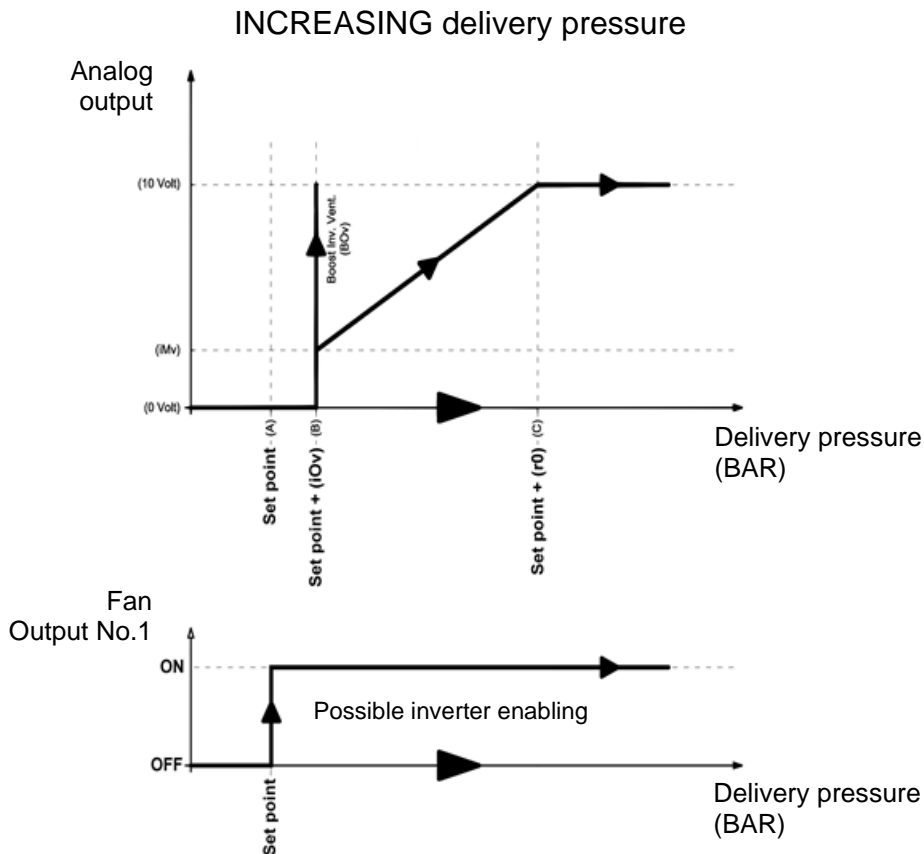

PRESSURE DECREASING (Graph 2):

With pressure values of the pressure probe equal to or greater than point (D) the analog output will be 10V.

Between point (D) and point (E) the analogue output will have a value proportional to the value of the pressure probe starting from the maximum value of 10V and reaching the minimum value iMv.

With pressure values lower than point (E) and higher than point (F) the constant analogue output will be at the minimum value iMv. The analog output of the regulator will be 0V for probe pressure values less than or equal to the point (F) representing the "Set point" value.

The digital output fans 1 represents "capacitor fan inverter enable" and is ON for pressure values greater than or equal to the set point and OFF for lower values.

Graph 2

DECREASING delivery pressure

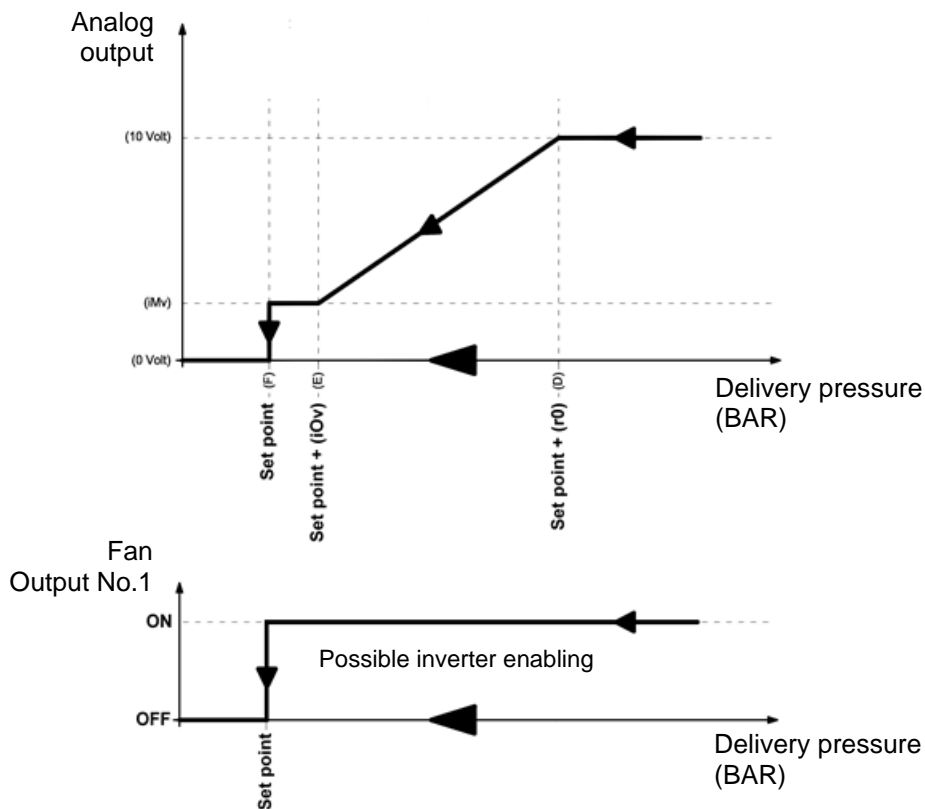

EVAPORATOR FAN MANAGEMENT

If Ao1=1 the evaporator fans are managed with the 0-10V output and the speed is set through the FsE parameter (from 20% = 2V to 100% = 10V).

In case of standby or alarms, the analogue output is immediately raised to 0V.

5.32

COLD ROOM DOOR SWITCH MANAGEMENT

Parameters: doC (2°), Tdo (2°).

When the door switch is opened, the evaporator fans turn off and the compressor will continue to operate for the **doC** time, after which it will turn off. After the **tdo** time, normal operation of the control is restored by giving the “open door” alarm signal (Ed). It is always possible to switch the light off or on manually using the light button , regardless of the status of the door switch.

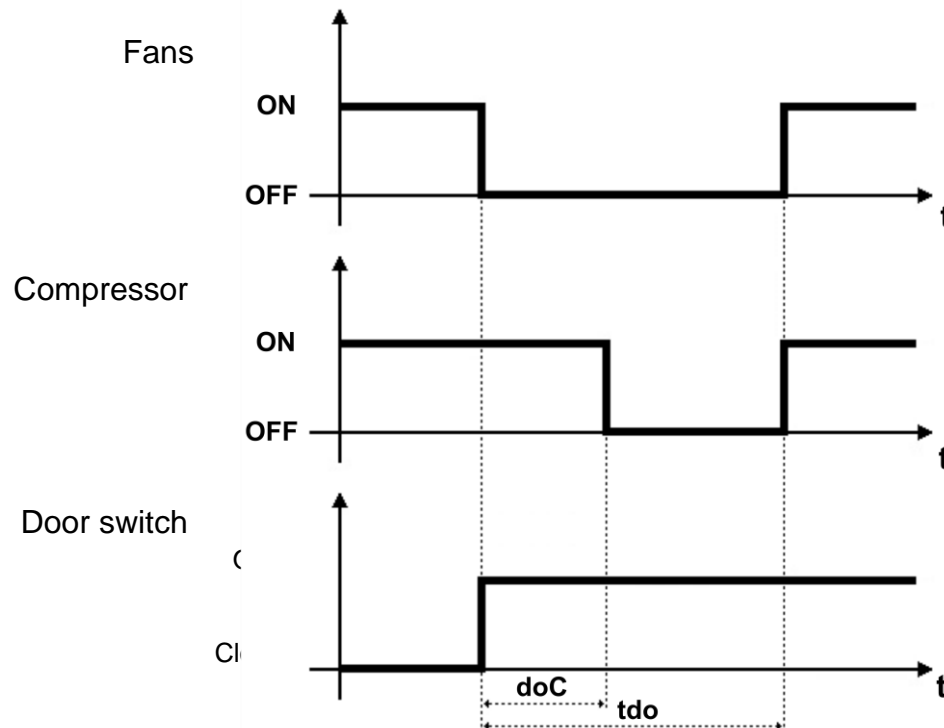

5.33

HUMIDIFICATION AND DEHUMIDIFICATION MANAGEMENT

Parameters: Au1/2 (3°), StU (2°), r1 (2°).

The **NECTOR** controller activates the humidity call when the ambient humidity drops below the set value **StU** minus the differential **r1**; it disengages the humidity call when the ambient humidity exceeds the set value. Configure Au1/2 = +/-7 to enable a digital output as humidification consent. The **NECTOR** controller activates the dehumidification call when the ambient humidity rises above the set value **StU** plus the differential **r1**; deactivates the dehumidification call when the ambient humidity is lower than the set value. Configure Au1/2 = +/-12 to enable a digital output as dehumidification consent.

NB: humidity management is not linked to temperature management. The compressor, fan, defrost, etc. calls are independent from the humidification / dehumidification calls. It is necessary to make the appropriate electrical connections to create any interlocks.

MONITORING

6.1

CONNECTION CONFIGURATION

The NECTOR controller is equipped with Bluetooth BLE, Wi-Fi or Ethernet connectivity for management or monitoring via remote devices (tablets, smartphones, PCs).

Remote management of the device takes place in the following ways:



	Distance	Support	Channel	Mode
MyPego app (BLE)	approx. 50m	Smartphone, Tablet	Bluetooth BLE	Control and monitoring
MyPego app (Cloud)	---	Smartphone, Tablet	Wi-Fi, Ethernet	Real-time monitoring and notifications. Control, if cCL=2.
Integrated webservice	---	Smartphone, Tablet, PC	Wi-Fi, Ethernet	Control (with cSL=2) and monitoring; network configuration required.

The myPego app is available on Google and Apple stores for free. It allows complete control of the NECTOR tool and is necessary to perform the basic operations to connect the device to the Internet (check IP address, enter Wi-Fi username and password, etc).

Through the same application it is possible to receive notifications from NECTOR tools in the event of an alarm and to monitor the status of registered devices (subscription function, see dedicated chapter).

To connect the NECTOR tool to the internet via wi-fi or Ethernet, proceed as follows:

- 1) Download **the myPego** app from the Google/Apple store and install it on a smartphone/tablet.

- 2) Activate Bluetooth on the NECTOR tool by pressing the  keys simultaneously  and for 5 seconds. The  flashing icon is activated.

- 3) Open the **myPego** app and access the Bluetooth section.



- 4) Touch the "Scan" key and the "Confirm" key to make the connection. The Bluetooth icon  on the instrument turns on steady to signal the connection.
- 5) The Homepage of the application opens, where it is possible to see the cold room temperature and to check the status of inputs and outputs.

6) In the selection bar below, tap the “Cloud” icon to access the network configuration menu.

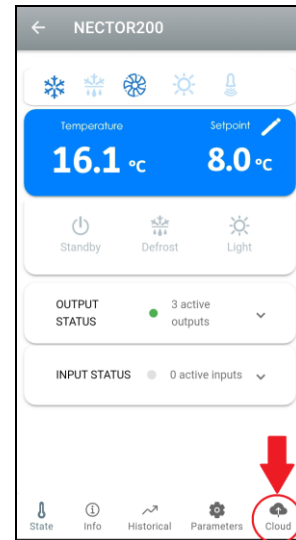

7) Upon first sign in, the myPego app prompts setting up of your Cloud connection. If relevant, continue by pressing the “Ok” key otherwise press “Cancel” and skip directly to step 14).

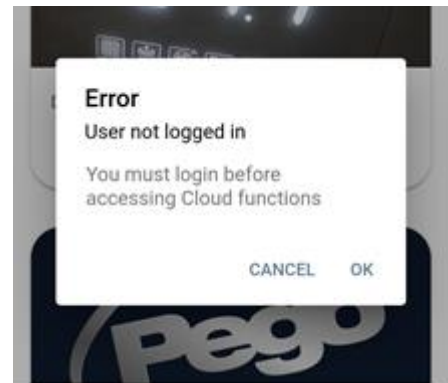

8) By clicking “Ok” in the previous point, the Login page opens. If already registered, enter the registration e-mail and password and click Login. Otherwise click "Sign in" to make the first registration.

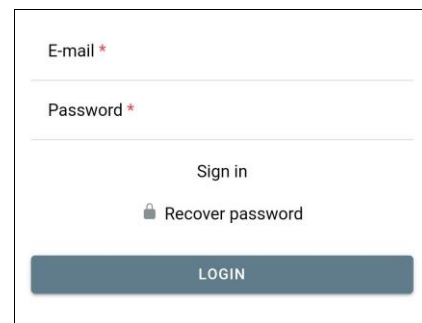

9) If you are registering for the first time, please enter a valid e-mail address and password. A verification email will be sent to the address indicated; click on the link in the email to confirm the registration. Once registration is confirmed, you will be able to log in with the account created (see point 8).

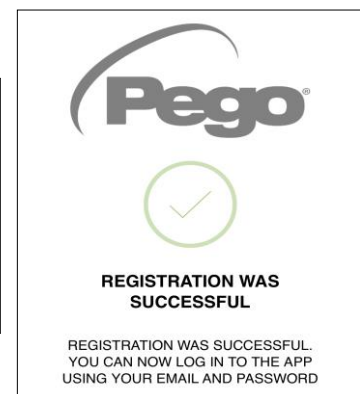
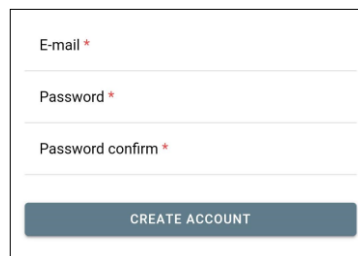

- 10) Once the user has been created (or logged in with an existing user), the device must be associated with an existing Cloud subscription; or create a new subscription. Touch the second link to associate the device with the registered user's cloud subscription.

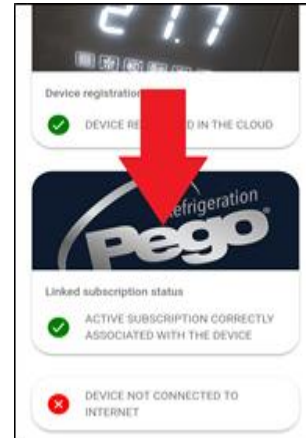

- 11) If the user does not have an active cloud subscription, the subscription activation page opens. Select the type of plan you need based on the number of instruments you want to monitor. Continue with the activation of the plan through the payment page.

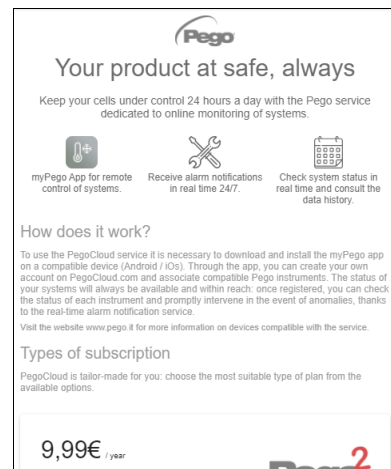

- 12) Enter your payment details. The charge will take place only after the trial period; the renewal of the subscription can be interrupted at any time.

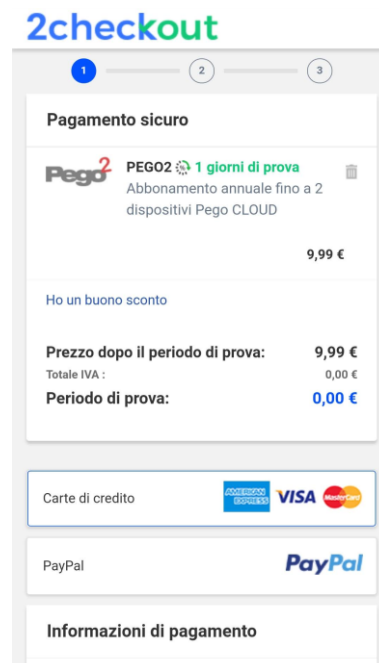

- 13) Once the subscription plan has been created, the instrument can be associated with the Cloud. Then go back to the "Cloud" page of the app (bluetooth side) and pair the device by clicking on the second tab. Turn the Nector off and on again. The device is thus associated with the subscription, but to allow data transmission it is necessary to configure the Wi-Fi / Ethernet connection to the internet.

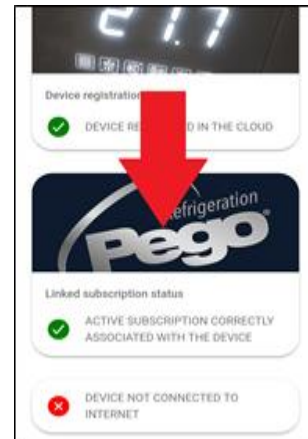



- 14) Touch the last link at the bottom "DEVICE NOT CONNECTED TO THE INTERNET" to configure the connection.

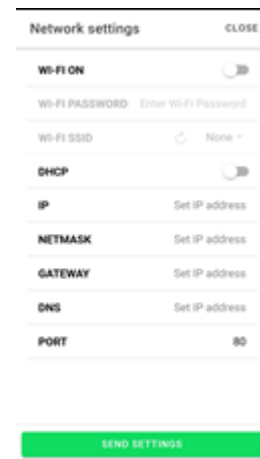

- 15) Configure the connection type:
- In the case of Ethernet connection: connect the cable to the NECTOR tool and set the DHCP or set the desired IP/NETMASK/GATEWAY configuration. Upon completion, touch the "Send Settings" key to configure the instrument. To enable DHCP, it will be necessary to return to this page after a few moments to verify the IP received from the DHCP server.
 - In the case of wi-fi connection: touch the WI-FI ON switch and configure the SSID and password of the network to which the NECTOR is to connect. At the end of the setting touch the "Send settings" button.



- 16) At the end of the configuration when the instrument connects (via wi-fi or Ethernet) the icon is activated  (after approximately one minute). It may be necessary to turn the NECTOR off and on again.

- 17) If the Cloud connection was configured (see points 6 and 7) after a few moments the icon is  activated to signal that the device is correctly sending the data to the Pego Cloud.

6.2

MyPego APP

The **myPego** app is the official Pego application for the control and supervision of NECTOR line tools.



My Pego® App



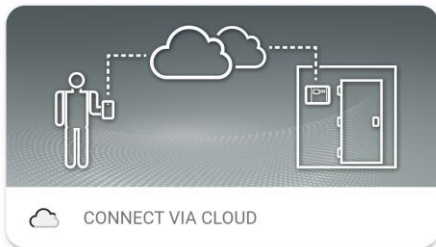

Direct connection to the device via Bluetooth BLE; monitoring system status; changing parameters and configuring Ethernet wi-fi connectivity.



Cloud connection: monitoring of the status of all devices registered in the subscription plan; reading parameters and daily history; receiving real-time alarm notifications from all registered devices. Full control with cCL=2.

Direct connection via Bluetooth

Choosing Bluetooth Connection, accesses the direct connection pages. Enable Bluetooth on the instrument with  the keys  and press together for 5 seconds and confirm the connection in the app to access the instrument status page.

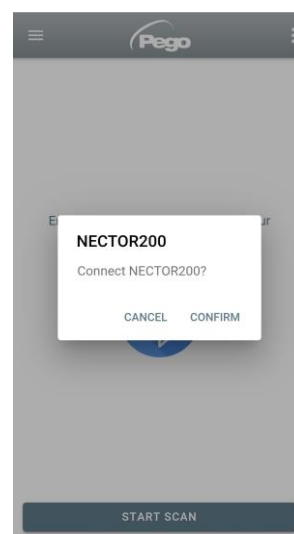
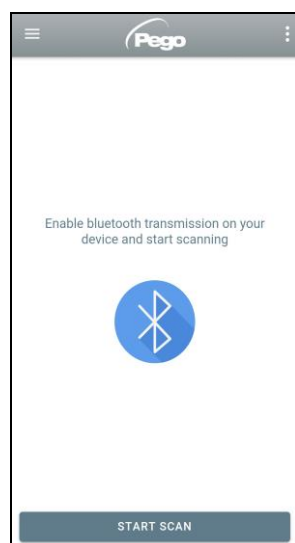

Connecting to Cloud Device

Choosing the Cloud Connection accesses the tool selection page. Here it is possible to select which of the registered instruments (through the procedure indicated in the previous chapter) it is possible to access to monitor the status of the system.

The  icon indicates that the tool is successfully transmitting data to the cloud. Tap the name of a tool to access its status page.

Note: If the icon is gray it may be necessary to correctly set the date and time on the instrument (parameters Hr, min, Yr, Mo, dy).

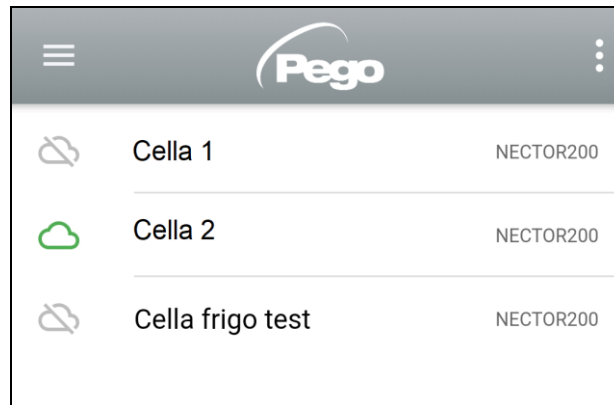

NECTOR instrument status

Once logged in (via Bluetooth if it is a nearby instrument or via Cloud if it is a remote instrument) the NECTOR status page opens. Here it is possible to:

- Read current ambient temperatures.
- Read the setpoint and modify it (if connected via Bluetooth).
- Check the status of inputs/outputs/alarms.

By tapping on the keys in the bottom bar it is possible to access the other configuration pages:

- Info Page

It contains the basic information of the instrument and the name by which the instrument is identified on the Cloud.

Cloud tool name, editable if connected in Bluetooth

Manual: link to download the pdf tool manual

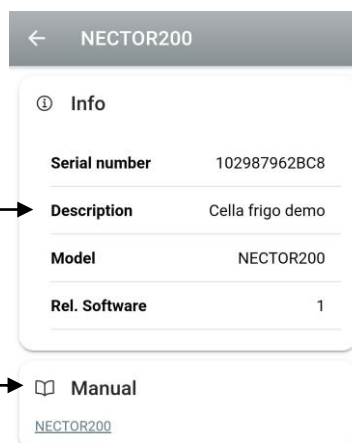

History Page

Displayed date: Tap to change the date

Graph: Tap to view the individual points

Legend: Touch the name of a probe to exclude or display it on the chart

Table: here it is possible to read the status of the probes and of any temperature alarms (red for High Temperature, blue for Low Temperature)

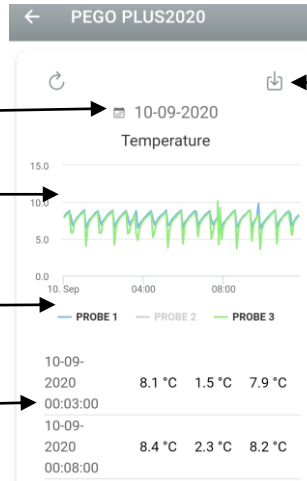

Downloading data: tap to download data in csv table format

Parameters page

Level selection: tap to change parameter level

Parameter identifier

Parameter description

Parameter value: tap to edit (only if cCL=2)

LEVEL	LEVEL	LEVEL	LEVEL
1	2	3	4
Set	Ambient temperature setpoint	7.0 °C	
r0	Temperature differential	2.0 °C	
d0	Defrost interval	6 hours	
dd2	Defrost start delay for the second evaporator	10 °C	
d21	Defrost end setpoint	15 °C	
d22	Defrost end setpoint	15 °C	
d31	Maximum defrost period	25 min	

Cloud Page

It's used to configure the cloud connection and network settings (see connection Configuration chapter).

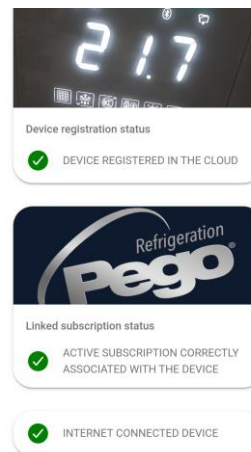

Device sharing

The "Device sharing" function allows you to share the Nector with other users (up to 3) even if they are not subscribers (it's sufficient that each user has his own account).

Users of device sharing:

- receive alarms and notifications.
- can check the status of the Nector device.
- can send commands and modify parameters (if cCL=2).

To share, the instrument must be correctly registered on Cloud.

Note: It's not possible to login with the same user from multiple different devices at the same time.

1. Open the tool in the Cloud section of the myPego app, go to the Cloud page and select the last link ("SHARE THIS DEVICE ON CLOUD").

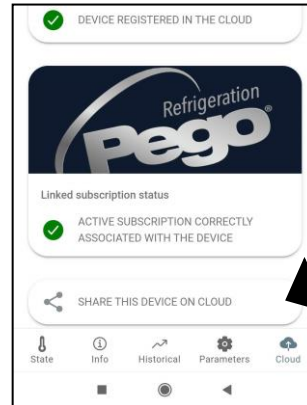

2. Touch the (+) symbol to add a shared user; in the window that appears enter the email address of the user with whom you want to share the Nector. Touch the "SHARE" button to share.

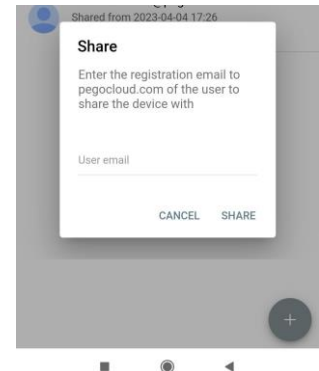
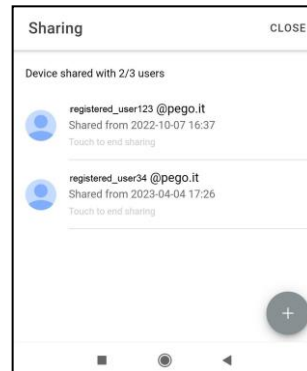

3. If sharing is successful, the user of device sharing is added to the list. The Nector can be shared with up to three users. The owner can stop sharing at any time by touching the icon next to the shared user.

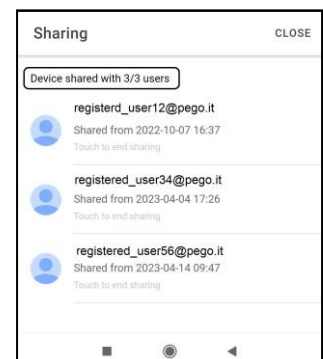
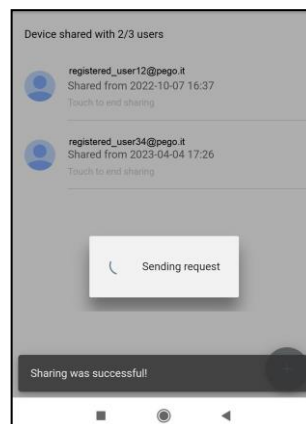

The NECTOR tool integrates a webserver that allows monitoring and modification of parameters through a normal web browser or direct http interfacing. To access the website of the tool it is necessary to know its IP address through the procedure described in the chapter "Connection configuration" (through the app myPego => Bluetooth connection => cloud card).

HTTP ACCESS

By sending requests appropriately formatted with http protocol to the IP address of the device, it is possible to access information in real time, modify parameters, send commands, etc. Access to this feature is password protected. Below is an example of communication between a third-party system (which sends the request) and the Nector (which sends the response).

Request:

`http://IP1.IP2.IP3.IP4/ajax_data.cgi?pgd='passcode'`

Answer:

```
{"temp": "23.8", "sttmp": "-0.5", "bg_temp": "1", "stby": "0", "ligh": "0", "def": "0", "almst": "0", "recst": "0"}
```

temp = current room temperature
bg_temp = reserved
ligh = cold room light status
almst = alarm present

sttmp = temperature setpoint
stby = stand-by status
def = defrost status
recst = active registrations

For further information, refer to the dedicated manual HTTP_NECTOR200_XX-YY_ENG.pdf (ask Pego for any updated versions of the document).

WEBSERVER

Then type the local IP address of the connected tool in the web browser address bar: the login page appears. Access to the NECTOR homepage is subject to access control by Username and password.

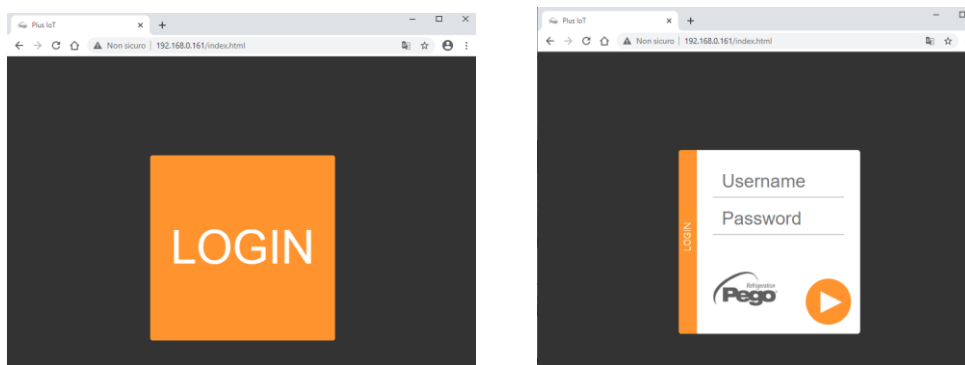

The NECTOR Web pages can be accessed in two modes, depending on the value of the cSL parameter (3rd parameter level):

- If cSL=1, Normal user: entering in the "Username" field the string "admin" and in the "Password" field the value set in the "PA" parameter (3rd level, e.g. if PA=6 enter password: "006") is accessed in read-only mode. Modification of the parameters, of the setpoint and manual activation of the outputs (e.g. light, defrost, etc.) are then inhibited.
- If cSL=2, Administrator user: entering in the "Username" field the string "admin" and in the "Password" field the value set in the "PA" parameter (3rd level, e.g. if PA=6 enter password: "006") there is full access to the functions. It is therefore possible to modify the parameters and to access all functions.

WEB INTERFACE: PAGES

The Web interface consists of some fixed sections:

- left: page navigation menu.
- top: Name of the page, serial number and type of user logged on.
- on the right: page content.

- Home Page

The screenshot shows the NECTOR web interface home page. The browser address bar displays '68.0.161/home.html?ID=86997988'. The page features a dark blue header with the 'PECTOR' logo and the 'Pego Refrigeration' logo. Below the header, the current page is labeled 'Live' and the user is identified as 's/n: 0000000001- admin'. The main content area displays the current temperature as '7.1 °C' and the setpoint as '7.0 °C'. A navigation menu on the left includes 'Live', 'I/O', 'Alarms', 'History', 'Command', 'Setup', 'Info', and 'Logout'. A control panel at the bottom contains buttons for 'Alarms', 'Datalogger', 'Light', and 'Defrost'. Callout boxes provide detailed information about these elements:

- Page Navigation Menu:** Points to the left sidebar menu.
- Current page:** Points to the 'Live' label.
- Current temperature (and temperature setpoint):** Points to the '7.1 °C' and '7.0 °C' display.
- Access type (admin or user):** Points to the 's/n: 0000000001- admin' text.
- Logout:** Points to the 'Logout' link in the navigation menu. Description: Disconnect user and return to the login page.
- Alarm signal:** Points to the 'Alarms' button. Description: - red: alarm in progress, - grey: no alarm.
- Buttons:** Points to the 'Light' and 'Defrost' buttons. Description: - green background: active function, - blue background: function not active, - grey background: function not active and not activated (normal user).

- I/O (Inputs / Outputs)

The screenshot shows the NECTOR web interface for a refrigeration unit. The browser address bar indicates the URL is 192.168.0.161/inoutput.html?ID=86997988. The page title is 'NECTOR' and the unit ID is 's/n: 0000000001- admin'. The left sidebar contains navigation options: Live, I/O, Alarms, History, Command, Setup, Info, and Logout. The main content area displays the I/O status for 12 analogue inputs and 3 digital outputs.

Analogue inputs		
IN 1	Ambient probe	7.6
IN 2	Defrost probe	0.8
IN 3	Datalogger probe	7.4
IN 4	Disabled	99.9
IN 5	Door switch	1
IN 6	Compressor protection	0
IN 7	Man in room alarm	0
IN 8	Remote standby	0
IN 9	Compressor thermal protection	0
IN 10	Pressure protection	0
IN 11	Condenser fan warning	0
IN 12	Disabled	99.9

Digital outputs		
OUT 1	Compressor	●
OUT 2	Defrost	●
OUT 3		●

Input/Output Terminal PIN

Input/Output Description (digital or analogue)

Input / Output Status
 If digital:
 - green: active input / output
 - grey: input / output not active
 If analog the analog input or output value is displayed

Datalogger => Table

On the “Datalogger => Table” page it is possible to view and print the daily data recorded in the NECTOR memory. To view the records, select a date from the calendar (click on the "Select a date" field) and click on the "Upload" button.

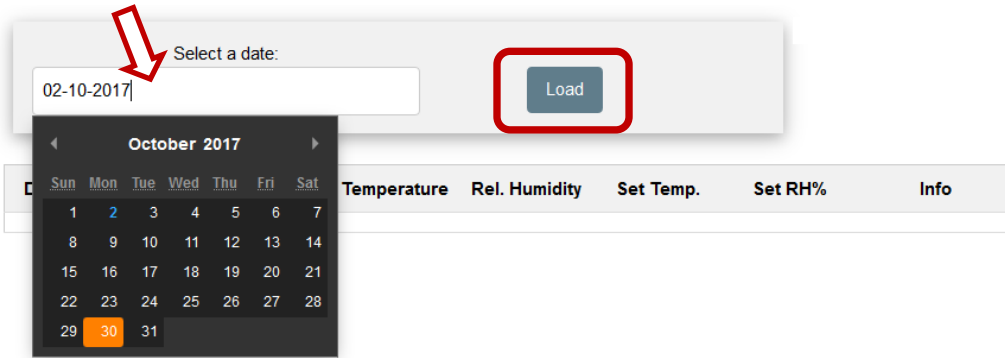

Print table
(on printer or pdf)

Pego

Refrigeration

NECTOR

102987962BC8- admin

Live

I/O

History ▾

Command ▾

Setup

Info

Logout

Table

Select a date:

Load
Print

Date and time	S1 °C	S2 °C	S3 °C	S4 °C	S5 Bar/RH%	Info
21-09-2020 10:37:23	25.00	99.90	25.10	99.90	999.00	S Pon DI2
21-09-2020 10:46:02	24.90	99.90	25.00	99.90	999.00	S Pon DI2
21-09-2020 10:56:00	25.00	99.90	25.00	99.90	999.00	S DI2
21-09-2020 11:06:00	25.00	99.90	25.00	99.90	999.00	S DI2
21-09-2020 11:16:00	25.00	99.90	25.00	99.90	999.00	S DI2

High alarm
Temperature, humidity or pressure value highlighted in red.

Turning on the controller
“Pon”

Stand-by status active
“S”
Digital input 2 active
“DI2”

Rev. 04-23

OPERATION AND MAINTENANCE MANUAL

Page 51

- Datalogger => Graph

On the "Datalogger => Graph" page it is possible to view and print the graph of the daily data recorded in the NECTOR memory. To view the chart, select a date from the calendar (click on the "Select a date" field) and click on the "Upload" button.

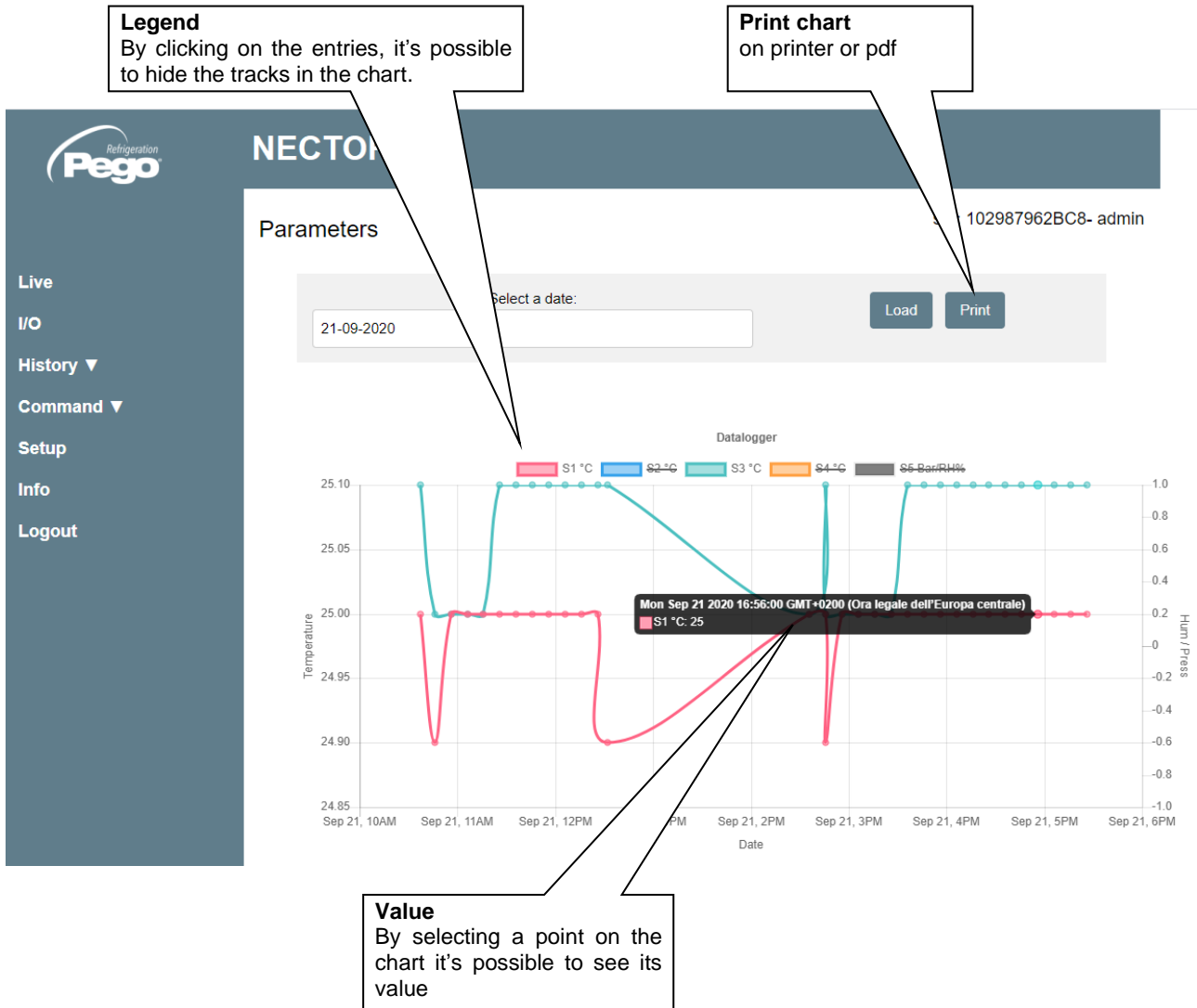

- Commands => Parameters

Parameter menu
Click on the arrow to view the parameter list

Parameter code	Parameter description	Current value	Increases or decreases value
dtC	Hot temperature differential	2.0 °C	+ -
dtF	Cold temperature differential	2.0 °C	+ -
dtn	Temperature neutral zone	0.0 °C	+ -

- Setup

On the "Setup" page it is possible to configure the language of the webserver.



Plus IoT x +
Non sicuro | 192.168.0.161/setup.html?ID=86997988

Refrigeration
Pego

NECTOR

Setup s/n: 000000001- admin

Language

 ITA	 ENG	 GER
--	---	--

Live
I/O
Alarms
History ▾
Command ▾
Setup
Info
Logout

- Info

Plus IoT x +
Non sicuro | 192.168.0.161/info.html?ID=86997988

Refrigeration
Pego

NECTOR

Info s/n: 000000001- admin

Pego S.r.l.
www.pego.it
info@pego.it
(+39)0425762906

Hardware version:
0.0.0.0

Bootloader version:
107.0.0.5

Live
I/O
Alarms
History ▾
Command ▾
Setup
Info
Logout

6.4

TELENET MONITORING/SUPERVISION SYSTEM

To connect the NECTOR to the TeleNET monitoring and supervision system perform the following steps:

1. Assign a unique network address using the 3rd level parameter **Ad** and set **Ser=0**.
2. The terminals of the TeleNET connection are indicated with RS-485(A) and RS-485(B) on the NECTOR board.
3. Observe the identification (A) and (B) of the RS-485 line, remembering that on the 2TWRS485 interface the terminal 3=(A) and 4=(B).
4. Do not make star connections on the RS485 line.

IMPORTANT: During configuration, under "Module" select "*PLUS Expert Series Tool*". Under "Module" it is also possible to configure:

- "TWMT tool" to display only the ambient temperature probe value;
- "TWMUR tool" to display the value of the probe configured as a humidity probe (parameter An5=1 or An5=2);
- "TWMP tool" to display the value of the probe configured as pressure probe (parameter An5=3).

The following is the typical connection of a NECTOR in a TeleNET network.

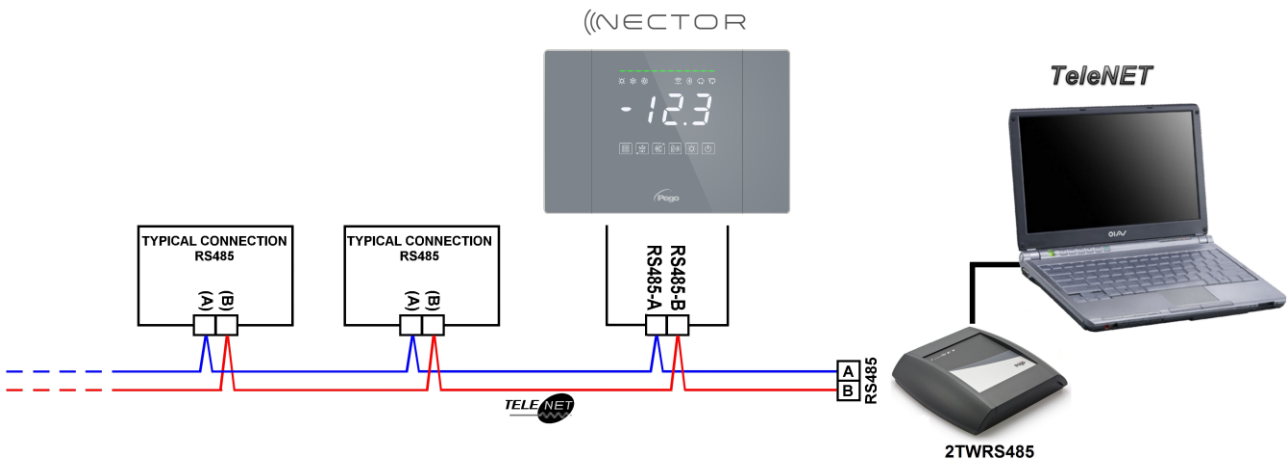

6.5

MODBUS-RTU PROTOCOL

To insert the panel into an RS485 network with Modbus-RTU protocol, set the Ser, Ad, Bdr and Prt parameters correctly, and follow the diagram below. Refer to the MODBUS-RTU_PLUSR200 manual (available on our website) for Modbus-RTU communication protocol specifications.

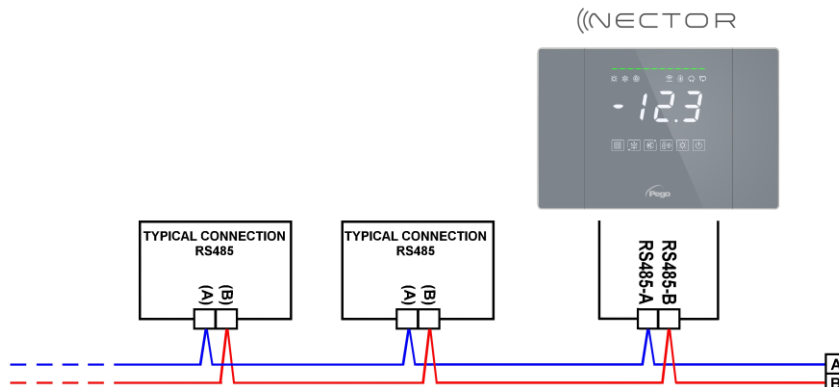

7.1

DIAGNOSTICS

In the event of any anomalies, the NECTOR system warns the operator through alarm codes, visual and acoustic signalling. When an alarm condition occurs, the red alarm bar is activated, the alarm relay and the buzzer are activated.

At any time by pressing the key  it is possible to silence the internal buzzer. Subsequent pressing of the SET key restores the sound signal and the display of the codes.

Minimum and maximum temperature alarms.

For these alarms it is possible to set by means of the parameter Ald a delay to their signalling. When the temperature alarm returns, the red bar remains active to signal the return of an alarm. To

reset the stored temperature alarm, press the key . The alarms E1, E2, E3, EH1, EH3, EL1, EL3 are stored in the datalogger and can be viewed together with the temperature history.

The alarm codes are listed below in order of priority:

ALARM CODE	POSSIBLE CAUSE	OPERATION TO BE PERFORMED
EP2	Low backup battery alarm (it can only be present if there is no power supply).	<ul style="list-style-type: none"> Restore mains power. If necessary, replace the backup battery.
EP1	Mains supply alarm absent	<ul style="list-style-type: none"> Restore mains power.
E0 E0i E0E	Eeprom alarm An error was detected in the EEPROM memory (outputs are all disabled except alarm outputs).	<ul style="list-style-type: none"> Switch the equipment off and on again. Reset to default values (page 28). Check that the wiring complies with the requirements.
Er	Data write alarm: the control is not storing the detected data correctly.	<ul style="list-style-type: none"> Contact the technical assistance service.
Eu 1 ÷ Eu 9	USB memory error.	<ul style="list-style-type: none"> See chapter 5.16.
E1	Functional anomaly of the ambient probe	<ul style="list-style-type: none"> Check the status of the ambient probe. If the problem persists, replace the probe.
E2	Functional fault of the defrosting probe (in this case, any defrosting will last for the time d3).	<ul style="list-style-type: none"> Check the status of the defrost probe. If the problem persists, replace the probe.
E3	Functional malfunction of the datalogger probe	<ul style="list-style-type: none"> Check the status of the datalogger probe. If the problem persists, replace the probe.
E4	Probe 4 functional abnormality	<ul style="list-style-type: none"> Check the status of the probe 4. If the problem persists, replace the probe.
E5	Probe 5 functional abnormality	<ul style="list-style-type: none"> Check the status of the probe 5. If the problem persists, replace the probe.
E6	Low clock battery alarm: the control will work for at least another 20 days; subsequently, if the power supply to the panel fails, the time setting (not the previously recorded data) will be lost.	<ul style="list-style-type: none"> Replace the clock battery (CR2032), located on the board on the front of the panel.
E8	Man in cold room alarm: the "man in cold room alarm" button inside the cold room has been pressed to signal a dangerous situation.	<ul style="list-style-type: none"> Check the hazardous situation and reset the button inside the cold room.
E9	Cold rom light alarm The light in the cold room remained on for longer than tLo.	<ul style="list-style-type: none"> Check that the door is closed. Check the electrical connections of the door switch.
EH1	Maximum ambient temperature alarm. An ambient temperature higher than that set for the maximum temperature alarm has been reached (see parameter A2).	<ul style="list-style-type: none"> Check the compressor status. The probe does not detect the temperature correctly or the compressor stop/run command does not work. If the problem persists, contact technical support.

ALARM CODE	POSSIBLE CAUSE	OPERATION TO BE PERFORMED
EH3	Datalogger maximum temperature alarm. The datalogger probe has reached a temperature higher than that set for the maximum temperature alarm (see parameter A2).	<ul style="list-style-type: none"> • Check the compressor status. • The probe does not detect the temperature correctly or the compressor stop/run command does not work. • If the problem persists, contact technical support.
EL1	Minimum ambient temperature alarm. The ambient probe has reached a temperature lower than that set for the minimum temperature alarm (see parameter A1).	<ul style="list-style-type: none"> • Check the compressor status. • The probe does not detect the temperature correctly or the compressor stop/run command does not work. • If the problem persists, contact technical support.
EL3	Datalogger minimum temperature alarm. The datalogger probe has reached a temperature lower than that set for the minimum temperature alarm (see parameter A1).	<ul style="list-style-type: none"> • Check the compressor status. • The probe does not detect the temperature correctly or the compressor stop/run command does not work. • If the problem persists, contact technical support.
Ed	Open door alarm: when the door switch is opened and the time tdo has elapsed, the normal operation of the control is restored by signalling "open door alarm" (Ed).	<ul style="list-style-type: none"> • Check that the door is closed. • Check the electrical connections of the door switch. • If the problem persists, contact technical support.
Ect	Compressor thermal protection insertion (the outputs are all deactivated except the alarm one, if present).	<ul style="list-style-type: none"> • Check the compressor status. • Check compressor absorption. • If the problem persists, contact technical support.
EcP	Compressor pressure switch protection insertion (the outputs are all deactivated except for the alarm one, if present).	<ul style="list-style-type: none"> • Check the compressor status. • Check the compressor protection pressure switch. • If the problem persists, contact technical support.
EcL	Compressor low pressure protection insertion (the outputs are all deactivated except the alarm one, if present).	<ul style="list-style-type: none"> • Check the compressor status. • Check the compressor protection pressure switch. • If the problem persists, contact technical support.
EcH	Compressor high pressure protection insertion (the outputs are all deactivated except the alarm one, if present).	<ul style="list-style-type: none"> • Check the compressor status. • Check the compressor protection pressure switch. • If the problem persists, contact technical support.
EcO	Compressor oil pressure switch protection insertion: (the outputs are all deactivated except for the alarm one, if present).	<ul style="list-style-type: none"> • Check the compressor status. • Check the compressor protection oil pressure switch. • If the problem persists, contact technical support.
Ec	Compressor generic protection alarm input (e.g. thermal protection or maximum pressure switch). The outputs are all deactivated except the alarm one, if present.	<ul style="list-style-type: none"> • Check the compressor status. • Check compressor absorption. • If the problem persists, contact technical support.
EcA	Compressor alarm (display only)	<ul style="list-style-type: none"> • Check the compressor status.
EFc	Condenser fan alarm (display only)	<ul style="list-style-type: none"> • Check the status of the condenser fans.
EFE	Evaporator fan alarm (display only)	<ul style="list-style-type: none"> • Check the status of the evaporator fans.
ES1	Network connection alarm (Wi-Fi, Ethernet, Bluetooth)	<ul style="list-style-type: none"> • If the problem persists, contact technical support.

MAINTENANCE

8.1

GENERAL SAFETY RULES

Whatever the nature of the maintenance, it must only be carried out by specialised technical personnel.



In the event of failure or maintenance of the electrical system, before proceeding with any check, the power supply to the panel must be disconnected by placing the main power switch in the open position (O). Check the absence of voltage with a Tester before any operation. Every element of the electrical panel, if it's faulty, must be replaced exclusively with original parts.

If the intervention involves parts outside the panel, perform the following steps:

- ❑ Permanently and safely disconnect the power supply to the panel in one of the following ways:
 - 1) Turn the main switch of the NECTOR to OFF to lock it in this position using a mechanical lock (Pego **ACC5ST3801** accessory).
 - 2) Disconnect the power supply upstream of our panel permanently by padlocking it to OFF.
- ❑ Place signs to indicate the machine being serviced.

Before proceeding with maintenance operations, perform the following safety requirements:

- ❑ The electrical panel must be powerless.
- ❑ Prevent the presence of unauthorised personnel in the intervention area.
- ❑ Place appropriate signs to indicate "Machine in Maintenance".
- ❑ Wear suitable work clothing (overalls, gloves, shoes, headgear) and free of loose appendages.
- ❑ Remove any objects that may become entangled in protruding parts of the panel.
- ❑ Have available accident prevention means and tools suitable for the operation.
- ❑ The tools must be well cleaned and degreased.
- ❑ Have the necessary technical documentation available to perform the maintenance work (wiring diagrams, tables, drawings, etc.).



At the end of the maintenance operations, remove all residual materials and thoroughly clean the panel.



It's absolutely forbidden to house additional parts inside the electrical panel.

The NECTOR is tested and adjusted at the factory as attested by the "calibration report" included in this package.

When it is in service, its periodic verification is necessary to ensure the reliability of the records as established by **UNI EN12830** and in accordance with **UNI EN13486**.

Verification is also necessary if the operating temperature deviates significantly from the test temperature reported in the calibration report.

The **recommended verification is annual** and can be carried out in the following ways:

- At an approved centre for the calibration of instruments: ACCREDIA centres for Italy (www.accredia.it); for other European countries consult the website with the list of centres authorised to verify the measuring instruments of the country concerned.
- For direct comparison using a measuring device, periodically checked with a multimeter and thermometer that are ACCREDIA tested and certified.

VERIFICATION RESULTS.

The Datalogger contained in the NECTOR series panels has a precision class of 1 so:

- If the difference between the value measured by the Datalogger and the reference value is between $\pm 1^{\circ}\text{C}$, the verification is **POSITIVE**.
- If the difference between the value measured by the Datalogger and the reference value is greater than $+1^{\circ}\text{C}$ or less than -1°C , the verification is **NEGATIVE**.

NB: All results of the verification must be recorded and kept.

If the verification fails, expert personnel can adjust the instrument on site by direct comparison with a digital reader and sample probe with a valid ACCREDIA calibration certificate. Contact Pego Support for the procedure to be followed.

8.3

SPARE PARTS AND ACCESSORIES

Spare parts and accessories for the **NECTOR** panel:

- SON103C4R1L1500 - NTC probe 10K 1% black 1.5m in length.
- SON103C4R1L3000 - NTC probe 10K 1% black 3m in length.
- SONNTC3MCE - NTC 10K 1% yellow probe of 3m length.
- Replacement card (complete front).
- 200P200RBATT - Backup battery.



Spare parts and accessories must be requested from your dealer.

8.4

CLEANING THE PANEL

For external cleaning of the panel, use only a damp cloth with a small quantity of neutral detergent.

8.5

DISPOSAL

The NECTOR panel consists of plastic, cables, printed circuit board and electronic components. With reference to Directive 2012/19/EU of the European Parliament and of the Council of 4 July 2012 and the relevant national legislation on the subject, we inform you that:

- There is an obligation not to dispose of WEEE as municipal waste and to carry out separate collection of such waste.
- Public or private collection systems provided for by local laws should be used for disposal. It is also possible to return the equipment to the distributor at the end of its life if a new one is purchased.
- This equipment may contain hazardous substances: improper use or improper disposal could have adverse effects on human health and the environment.



- The symbol  (crossed-out wheeled bin) on the pack, product and instructions indicates that the equipment was placed on the market after 13 August 2005 and must be collected separately.
- In the event of improper disposal of electrical and electronic waste, penalties are established by current local regulations on disposal.

NB: In case of replacement of the spare battery and/or clock battery, do not dispose of in the rubbish but use the appropriate collection centres for proper disposal.

ATTACHMENTS**A.1****EU DECLARATION OF CONFORMITY**

LA PRESENTE DICHIARAZIONE DI CONFORMITA' E' RILASCIATA SOTTO LA RESPONSABILITA' ESCLUSIVA DEL FABBRICANTE:
THIS DECLARATION OF CONFORMITY IS ISSUED UNDER THE EXCLUSIVE RESPONSIBILITY OF THE MANUFACTURER:



PEGO S.r.l. Via Piacentina 6/b, 45030 Occhiobello (RO) – Italy –
 Società soggetta all'attività di direzione e coordinamento di Castel S.r.l.

DENOMINAZIONE DEL PRODOTTO IN OGGETTO / DENOMINATION OF THE PRODUCT IN OBJECTMOD.: **NECTOR**

IL PRODOTTO DI CUI SOPRA E' CONFORME ALLA PERTINENTE NORMATIVA DI ARMONIZZAZIONE DELL'UNIONE EUROPEA:
THE PRODUCT IS IN CONFORMITY WITH THE RELEVANT EUROPEAN HARMONIZATION LEGISLATION:

Direttiva Bassa Tensione (LVD): **2014/35/UE**
Low voltage directive (LVD): **2014/35/EU**

Direttiva EMC: **2014/30/UE**
Electromagnetic compatibility (EMC): **2014/30/EU**

LA CONFORMITA' PRESCRITTA DALLA DIRETTIVA E' GARANTITA DALL'ADEMPIMENTO A TUTTI GLI EFFETTI DELLE SEGUENTI NORME:
THE CONFORMITY REQUIRED BY THE DIRECTIVE IS GUARANTEED BY THE FULFILLMENT TO THE FOLLOWING STANDARDS:

Norme armonizzate: **EN 61326-1:2013 +A1+A2+A3, EN 12830:1999, EN 13485:2001, EN 13486:2001, EN 61000-6-1:2007, EN 61000-6-3:2007 EN 60730-1:2016, EN 60730-2-9:2010**
 European standards: **EN 61326-1:2013 +A1+A2+A3, EN 12830:1999, EN 13485:2001, EN 13486:2001, EN 61000-6-1:2007, EN 61000-6-3:2007 EN 60730-1:2016, EN 60730-2-9:2010**

Firmato per nome e per conto di:
Signed for and on behalf of:

Pego S.r.l.
Martino Villa
Presidente

Luogo e Data del rilascio:
Place and Date of Release:

Occhiobello (RO), 01/01/2022

**NECTOR200, NECTOR200CB, NECTOR200CR, NECTOR200B
CONNECTION DIAGRAM**

A.2

INPUTS

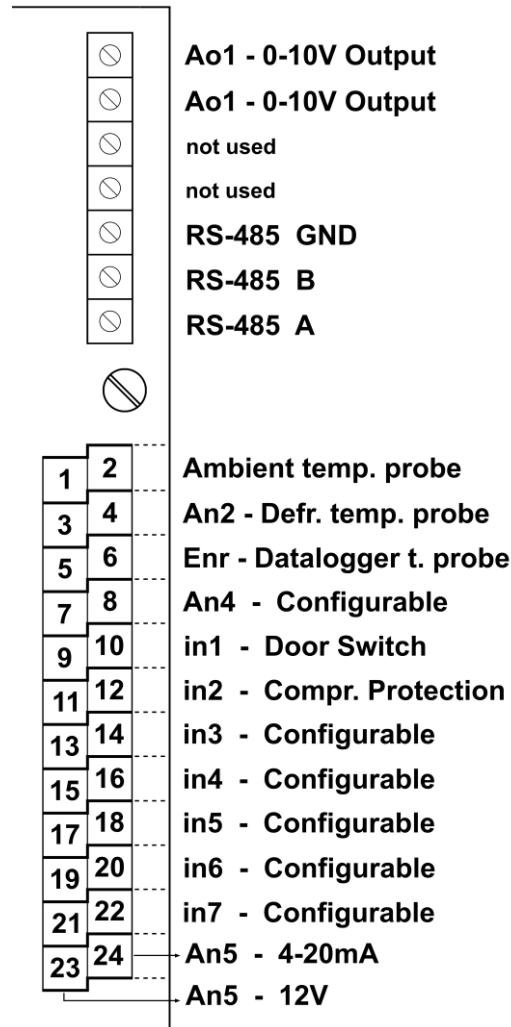

OUTPUTS

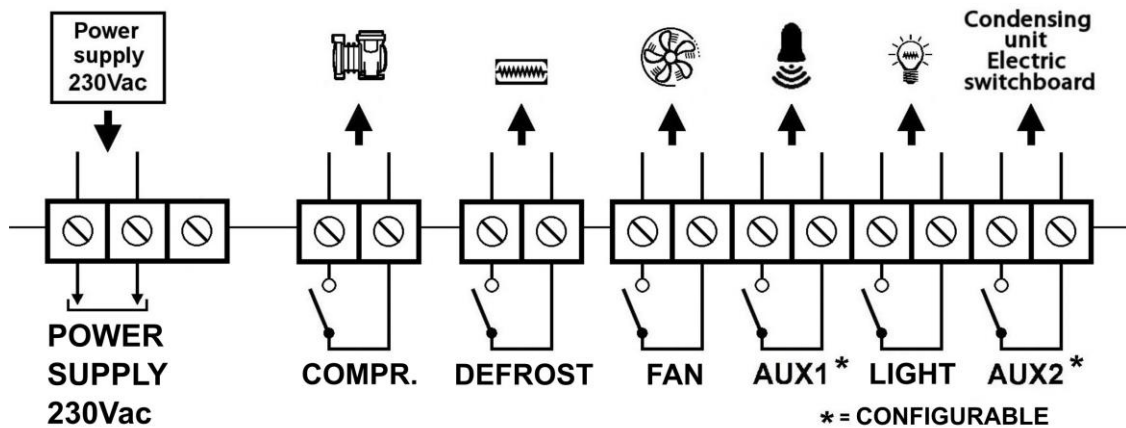

INPUTS

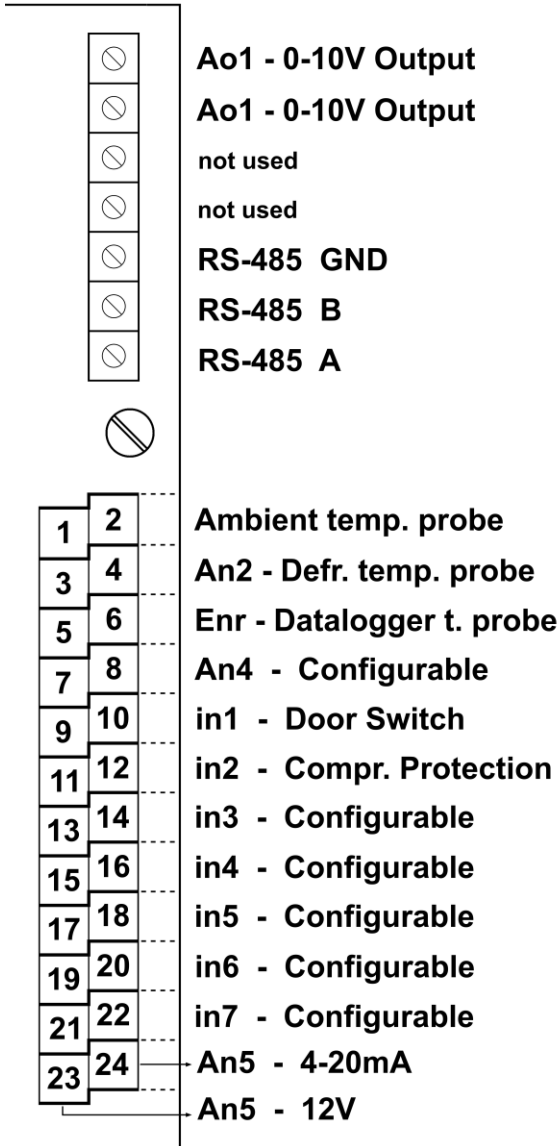

OUTPUTS

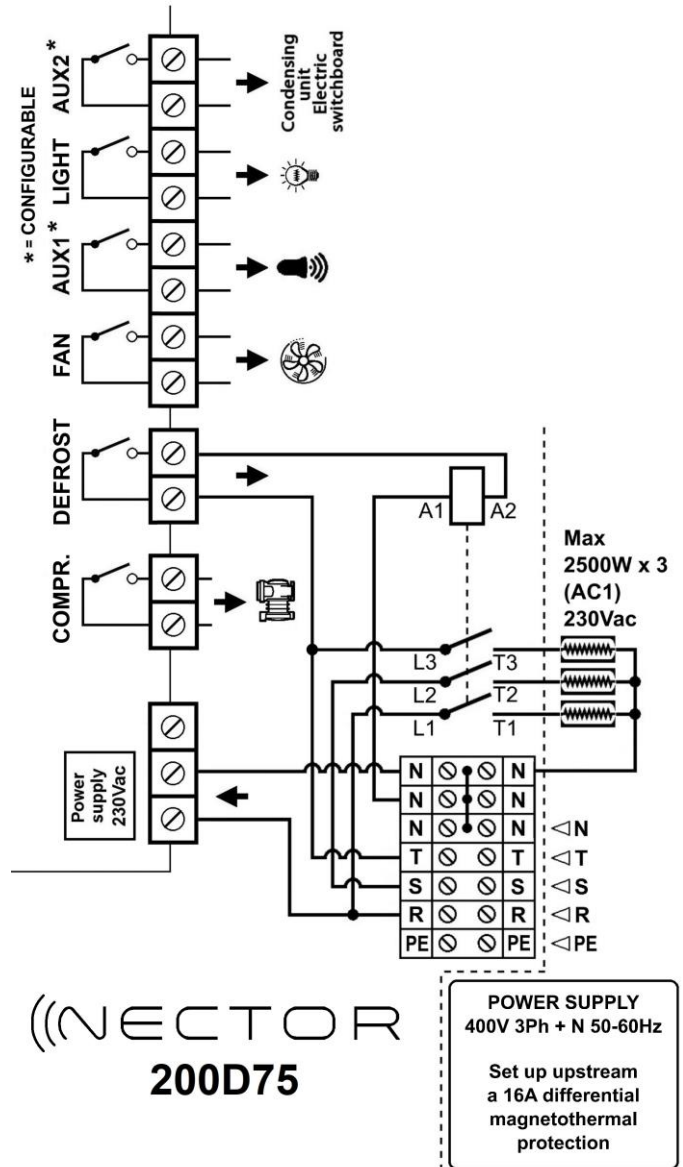



PEGO S.R.L.
Via Piacentina, 6/b 45030 Occhiobello (RO) – ITALY
Tel. +39 0425 762906
e-mail: info@pego.it – www.pego.it

TECHNICAL ASSISTANCE
Tel. +39 0425 762906 e-mail: tecnico@pego.it

Distributor: